



SmartGen
ideas for power

HGM7100N SERIES (HGM7110N/7120N) GENSET CONTROLLER USER MANUAL



SMARTGEN (ZHENGZHOU) TECHNOLOGY CO., LTD.



Chinese trademark

SmartGen English trademark

SmartGen — make your generator *smart*

SmartGen Technology Co., Ltd.

No.28 Jinsuo Road

Zhengzhou

Henan Province

P. R. China

Tel: 0086-371-67988888/67981888

0086-371-67991553/67992951

0086-371-67981000(overseas)

Fax: 0086-371-67992952

Web: www.smartgen.com.cn

www.smartgen.cn

Email: sales@smartgen.cn

All rights reserved. No part of this publication may be reproduced in any material form (including photocopying or storing in any medium by electronic means or other) without the written permission of the copyright holder.

Applications for the copyright holder's written permission to reproduce any part of this publication should be addressed to SmartGen Technology at the address above.

Any reference to trademarked product names used within this publication is owned by their respective companies.

SmartGen Technology reserves the right to change the contents of this document without prior notice.

Table 1 - Software Version

Date	Version	Note
2017-08-26	1.0	Original release.



CONTENTS

1	OVERVIEW	5
2	PERFORMANCE AND CHARACTERISTICS	5
3	SPECIFICATION OPERATION	7
4	OPERATION	8
4.1	KEY FUNCTION	8
4.2	CONTROLLER PANEL	9
4.3	AUTO START/STOP OPERATION	10
4.3.1.	ILLUSTRATION	10
4.3.2.	AUTO START SEQUENCE	10
4.3.3.	AUTO STOP SEQUENCE	10
4.4	MANUAL START/STOP OPERATION	11
4.5	EMERGENCY START UP	11
5	BREAKER CONTROL PROCESS OF GENSET CONTROLLER	12
5.1	HGM7120N BREAKER CONTROL PROCESS	12
5.1.1.	MANUAL SWITCHING PROCESS	12
5.1.2.	AUTO SWITCHING PROCESS	12
5.2	HGM7110N BREAKER CONTROL PROCESS	13
5.2.1.	MANUAL SWITCHING PROCESS	13
5.2.2.	AUTO SWITCHING PROCESS	13
6	PROTECTION	14
6.1	WARNINGS	14
6.2	SHUTDOWN ALARM	16
6.3	TRIP AND STOP ALARM	18
6.4	TRIP ALARM	18
7	WIRINGS CONNECTION	19
8	SCOPES AND DEFINITIONS OF PROGRAMMABLE PARAMETERS	22
8.1	CONTENTS AND SCOPES OF PARAMETERS	22
8.2	DEFINITION CONTENT OF PROGRAMMABLE OUTPUT PORTS 1~6	22
8.2.1.	CUSTOM PERIOD OUTPUT	35
8.2.2.	CUSTOM COMBINED OUTPUT	35
8.3	DEFINED CONTENTS OF CONFIGURABLE INPUT PORTS 1~7	36
8.4	SELECTION OF SENSORS	38
8.5	CONDITIONS OF CRANK DISCONNECT SELECTION	39
9	PARAMETERS SETTING	40
9.1	MENU ITEMS	40
9.2	CONTROLLER PARAMETER SETTINGS	40
9.3	LANGUAGE SELECTION	40
9.4	EVENT LOG	40
9.5	CONTROLLER INFORMATION	40
9.6	TIME SETTING	41
9.7	CYCLE START SETTING	41
9.8	BATTERY UNDER VOLTAGE START SETTING	41
10	GENSETS CYCLE START	41



11 SENSOR SETTING	42
12 COMMISSIONING	43
13 TYPICAL APPLICATION.....	44
14 INSTALLATION	46
14.1 FIXING CLIPS.....	46
14.2 OVERALL DIMENSION	46
15 TROUBLESHOOTING.....	48

SmartGen

1 OVERVIEW

HGM7110N/HGM7120N series power station automation controllers integrate digitization, intelligentization and network technology which are used for genset automation and monitor control system of single diesel unit to achieve remote start/stop, data measurement, alarm protection and etc. functions. It fit with LCD display, optional languages interface (Chinese, English and etc.), and it is reliable and easy to use.

HGM7110N/HGM7120N series power station automation controllers adopt 32-bit micro-processor technology with precision parameters measuring, fixed value adjustment, time setting and set value adjusting and etc. Almost parameters can be configured from front panel of controller, and all parameters can be adjusted through PC software via USB/RS485 port and monitored through PC software via RS485. It can be widely used in all types of genset control automation system with compact structure, simple connections and high reliability.

2 PERFORMANCE AND CHARACTERISTICS

HGM7110N: ASM (Automatic Start Module), it controls generator to start/stop by remote signal;

HGM7120N: AMF (Auto Mains Failure), updates based on HGM7110N, especially suit for automatic system composed by generator and mains.

Main features as follows:

- 32-bit ARM microcomputer has been used with higher level of hardware integration and stability.
- 132x64 LCD with backlight and selectable language interface (Chinese, English, and other languages) that can be chosen on the spot. It is convenient for debugging personnel commissioning.
- Hard-screen acrylic material been used to protect screen with great wear-resisting and scratch-resisting functions.
- Silicone panel and pushbuttons can be used in extreme temperature environment.
- RS485 communication interface enable “three remote functions” (remote control, remote measuring and remote communication) according to MODBUS protocol.
- Suitable for 3-phase 4-wire, 3-phase 3-wire, single phase 2-wire, and 2-phase 3-wire systems with voltage 120/240V and frequency 50/60Hz;
- Collects and shows 3-phase voltage, current, power parameter and frequency of generator or mains.

Mains

Line voltage (Uab, Ubc, and Uca)

Phase voltage (Ua, Ub, and Uc)

Frequency Hz

Phase sequence

Generator

Line voltage (Uab, Ubc, and Uca)

Phase voltage (Ua, Ub, and Uc)

Frequency Hz

Phase sequence

Load

Current Ia, Ib, Ic

A (unit)

Each phase and total active power P

kW (unit)

Reactive power Q

kvar (unit)

Apparent power S

kVA (unit)

Power factor PF

Accumulate total generator power W

kWh (unit)

Output percentage with load

%

- For Mains, controller has over and under voltage, over and under frequency, loss of phase , and

phase rotation detection functions; for generator, controller has over and under voltage, over and under frequency, over current and over power, reverse power, loss of phase, phase rotation detection functions.

— Precision collect parameters about Engine.

Temp. (WT)	°C/°F both be displayed
Oil Pressure (OP)	kPa/psi/bar all be displayed
Fuel Level (FL)	%(unit)
Speed (RPM)	r/min (RPM)
Voltage of Battery	V (unit)
Voltage of Charger	V (unit)

Total running accumulation maximum 65535 hours can be recorded.

Start times accumulation maximum 65535 times can be recorded

- Protection: automatic start/stop of the diesel gen-set, ATS (Auto Transfer Switch) control with perfect fault indication and protection function.
- With ETS (energize to stop), idle control, pre-heat control and rise/drop speed control functions, which are all relay outputs.
- Parameter setting: parameters can be modified and stored in internal FLASH memory and cannot be lost even in case of power outage; most of them can be adjusted using front panel of the controller and also can be modified using PC via RS485/ETHERNET port.
- Multiple temperatures, pressure, oil pressure sensor curves can be used and self-defined directly.
- Multiple crank disconnect conditions (speed, oil pressure, generator frequency) are optional.
- Widely power supply range DC(8~35)V, suitable to different starting battery voltage environment.
- Event log, real-time clock, scheduled start & stop generator (can be set as start genset once a day/week/month whether with load or not). Two gensets cycle start function.
- One minute before genset fault shutdown, controller can record data up to 5 pieces include mains voltage, mains frequency, generator voltage, generator frequency, current temperature, oil pressure, fuel level, speed and etc..
- It is used for pumping unit, moreover, can be indicating instrument as well (only indicate and alarm, relay without action).
- Maintenance function, maintenance time due can be user-defined (only warning/trip shutdown/alarm shutdown).
- Cycle start two gensets via RS485 (running time of both main unit and standby unit can be user defined)
- Waterproof security level IP65 due to rubber seal installed between the controller enclosure and panel foil.
- Controller uses metal fixing clips.
- Modular design, pluggable connection terminals and embedded installation way, and compact structure with easy mounting.

3 SPECIFICATION OPERATION











Table 2 - Technical Parameters

Items	Contents
Operating Voltage	DC8.0V to DC35.0V, Continuous Power Supply.
Power Consumption	<4W (standby \leq 2W)
Alternator Volt Input Range	
3Phase 4Wire	15V AC - 360 V AC (ph-N)
3Phase 3Wire	30V AC - 620 V AC (ph-ph)
Single Phase 2Wire	15V AC - 360 V AC (ph-N)
2Phase 3Wire	15V AC - 360 V AC (ph-N)
Alternator Frequency	50 Hz/60Hz
Speed sensor voltage	1.0V to 24.0V (RMS)
Speed sensor Frequency	10,000 Hz (max.)
Starter Relay Output	16 A 28V DC at supply output
Fuel Relay Output	16 A 28VDC at supply output
Programmable Relay Output 1	7A 28V DC power supply output
Programmable Relay Output 2	8A 250V AC volt free output
Programmable Relay Output 3	16A 250V AC volt free output
Programmable Relay Output 4	16A 250V AC volt free output
Programmable Relay Output 5	7A 28V DC power supply output
Programmable Relay Output 6	7A 28V DC power supply output
Case Dimension	209mm x 166mm x 45mm
Panel Cutout	186mm x 141mm
CT Secondary Current	5A rated
Working Conditions	Temperature: (-25~+70) $^{\circ}$ C; Humidity: (20~93)%
Storage Condition	Temperature: (-25~+70) $^{\circ}$ C
Protection Level	IP65 Front panel
Insulating Intensity	Apply AC2.2kV voltage between high voltage terminal and low voltage terminal; The leakage current is not more than 3mA within 1min.
Weight	0.6kg

4 OPERATION

4.1 KEY FUNCTION

Table 3 - Key Function Descriptions

Icon	Function	Description
	Stop/ Reset	Stop running generator in Auto/Manual mode; In stop mode, in case of alarm condition, pressing the button will reset alarm; Pressing and holding the button for 3 seconds will test indicator lights (lamp test); During stopping process, press this button again to stop generator immediately.
	Start	Under manual mode, press this button will start genset;
	Manual	Pressing this key will set the module into manual mode.
	Auto	Pressing this key will set the module into auto mode.
	C/O	Pressing this key to control breaker close or open in C/O interface under manual mode. (only suit for HGM7120N)
	Close	Pressing this key to control breaker close under user manual mode. (only suit for HGM7110N)
	Open	Pressing this key to control breaker open under user manual mode. (only suit for HGM7110N)
	Set/Confirm	Pressing this key will enter into Main Menu; In setting parameter status, press this key will shift cursor or confirm setting value.
	Up/Increase	Scrolls the screen up; Shift the cursor up or increase the set value in parameter setting menu.
	Down/Decrease	Scrolls the screen down; Shift the cursor down or decrease the set value in parameter setting menu.
	Homepage/Return	Controller returns to homepage if pressed this key in main screen; controller returns to the previous page if pressed this key in parameter setting page; hold and press this key for 3 seconds, trip alarm can be reset.

 **Note: press any key to mute alarms in main screen.**

4.2 CONTROLLER PANEL



Figure 1 - HGM7110N Front Panel Indication



Figure 2 - HGM7120N Front Panel Indication

NOTE: Part of indicator lights illustration:

Table 4 - Alarm Indicator Description

Alarm Type	Alarm Indicators
Warning alarm	slowly flash (once per second)
Trip alarm	slowly flash (once per second)
Shutdown alarm	fast flash (5 times per second)
Trip and stop alarm	fast flash (5 times per second)

▲NOTE:

- a) **Status Indicators:** after crank disconnect, light is always on before ETS; light is off when standby.
- b) **Gen Normal Indicator:** always on when generator is normal; flash when generator is in fault; light is off when generator is standby.
- c) **Mains Normal Indicator:** always on when mains is normal; flash when mains is in fault; light is off when gen is standby.

4.3 AUTO START/STOP OPERATION

4.3.1. ILLUSTRATION

Press  , its indicator lights, and controller enters **Auto Start** mode.

4.3.2. AUTO START SEQUENCE

- a) **HGM7120N:** When Mains is abnormal (over and under voltage, over and under frequency, loss of phase and phase rotation), it enters into mains “abnormal delay” and LCD display countdown time. When mains abnormal delay is over, it enters into “start delay”.
- b) **HGM7110N:** Generator enters into “start delay” as soon as “Remote Start on Load” is active.
- c) Start Delay countdown is shown on LCD.
- d) When start delay is over, preheat relay outputs (if this be configured), “preheat start delay XX s” is shown on LCD.
- e) When preheat delay is over, fuel relay outputs 1s and then start relay output; if engine crank fails during “cranking time”, the fuel relay and start relay deactivated and enter into “crank rest time” to wait for next crank.
- f) If engine crank fails within setting times, controller will initiate fail to start shutdown signals and fail to start message appears on LCD display at the same time.
- g) In case of successful crank attempt, “safety on timer” starts. During this period, low oil pressure, high water temperature, under speed, and charge failure alarms are disabled. As soon as this delay is over, “start idle delay” is initiated (if configured).
- h) During “start idle delay”, under speed, under frequency, under voltage alarms are inhibited. When this delay is over, “warming up delay” starts (if configured).
- i) When “warming up delay” is over, if generator state is normal, its indicator will be illuminated. If voltage and frequency has reached on-load requirements, the closing relay will be energized, generator will accept load, generator power indicator will turn on, and generator will enter Normal Running state; if voltage and frequency are abnormal, the controller will initiate shutdown alarm (shutdown alarm will be displayed on LCD alarm page).

▲NOTE: when remote start (off-load) signal input is active, the auto start sequence is the same as above except in item i), generator closing relay will not output, and genset is off-load.









4.3.3. AUTO STOP SEQUENCE

- a) HGM7120N, when mains return to normal during gen-set running, controller enters into mains voltage “Normal delay”. After mains normal status confirmed, mains status indicator is illuminate and “stop delay” initiated.
- b) HGM7110N, generator enters into “stop delay” as soon as “Remote Start” input is inactive.
- c) When stop delay is over, close generator relay is un-energized; generator enters into “cooling down time”. After “switch transfer delay”, close mains relay is energized. Mains on load and generator



indicator extinguished while mains indicator lights.

- d) Idle relay is energized as soon as entering “stop idle delay” (if configured).
- e) If enter “ETS hold delay”, ETS relay is energized. Fuel relay is deactivated and whether stop or not is auto judged.
- f) Then enter gen-set “wait for stop time”, and whether stop or not is auto judged.
- g) Enter “after stop time” after gen-set stopped completely. If genset fail to stop, controller will initiate fail to stop alarms (if gen-set stopped after the alarms, it will enter into “after stop time” and fail to stop alarms will be eliminated automatically).
- h) Enter standby status as soon as “after stop time” is over.

4.4 MANUAL START/STOP OPERATION

- a) **HGM7120N:** Manual mode is selected by pressing the  button; a LED besides the button will illuminate to confirm the operation; press  button to start the genset, it can automatically judge crank success and accelerate to high speed running. If high temperature, low oil pressure, over speed and abnormal voltage occur during diesel genset running, controller can effectively protect genset to stop (detail procedures please refer to No. d~i of Auto start sequence). Under **Manual Mode**, load breaker won't transfer automatically and   C/O key should be pushed manually to enter into the C/O interface.
- b) **HGM7110N:** Manual mode is selected by pressing the  button; a LED besides the button will illuminate to confirm the operation; then press  button to start the generator, it can automatically judge crank success and accelerate to high speed running. If high temperature, low oil pressure, over speed and abnormal voltage occur during genset running, controller can effectively protect genset to stop (detail procedures please refer to No. d~i of Auto start sequence). After genset high speed normal running, press the key  to close generator and generator is on-load.
- c) **Manual stop:** pressing  key can stop the running genset. (detail procedures please refer to No. c~h of Auto stop sequence)

4.5 EMERGENCY START



Simultaneously press  and  in manual mode will force generator to crank. Successful start will not be judged according to crank disconnect conditions, operator will have to crank the starter motor manually; when operator decides that the engine has fired, he/she should release the button and start output will be deactivated, safety on delay will be initiated.









5 BREAKER CONTROL PROCESS OF GENSET CONTROLLER

5.1 HGM7120N BREAKER CONTROL PROCESS

5.1.1. MANUAL SWITCHING PROCESS

Breaker is switched by manual control if controller in manual mode.

Operator controls load transfer of ATS via pressing   button.

- a) When breaker open detection is disabled, (1) press generator   button, open breaker will output if generator is on-load; generator will be closed if load is disconnect; mains will be opened if mains is on-load, and generator is closed after open delay is over; (2) press mains   button, if mains is on-load, open breaker output; if load is disconnect, mains will be closed; if generator is on-load, generator will be opened, and mains will be closed after open delay is over.
- b) When breaker open detection is enabled, if transfer mains on-load into generator on-load, mains   button need to be pressed firstly, and then press generator   button after open delay is over (no actions if press generator close button only). It is the similar way to transfer generator on-load into mains on-load.

5.1.2. AUTO SWITCHING PROCESS

Breaker is switched by automatic control if controller in auto mode or stop mode.

- a) If input port configured as close status auxiliary input

When breaker open detection is enabled, if transfer the load from mains to generator, Fail to Transfer Detection starts while breaker open outputting after open delay and transfer delay, and when detection time is over, if breaker fails to open, generator will not be closed, otherwise, gen will switch-on. Then Fail to Transfer Detection starts again while closing generator, if gen fails to close after detection time expired, it will wait for next close signal (if fail to transfer warning enabled, alarms will be initiated if fail to C/O). It is the similar way to transfer generator on-load into mains on-load.

When breaker open detection is disabled, if transfer the load from mains to generator, generator will be closed after open delay and transfer delay. Then Fail to Transfer Detection starts while closing generator, if gen fails to close after detection time expired, it will wait for next close signal (if fail to transfer warning enabled, alarms will be initiated if fail to C/O).

- b) If input port not configured as close status auxiliary input



If transfer the load from mains to generator, generator will be closed after open delay and transfer delay. It is the similar way to transfer generator on-load into mains on-load.

5.2 HGM7110N BREAKER CONTROL PROCESS

5.2.1. MANUAL SWITCHING PROCESS

Breaker is switched by manual control if controller in manual mode.

Operator controls breaker switch via pressing   button.

Close generator breaker output if gen is not loaded after pressing  button; open generator breaker output if gen is on-load after pressing  button.

5.2.2. AUTO SWITCHING PROCESS

Breaker is switched by automatic control if controller in auto mode.

a) If input port configured as close status auxiliary input

When breaker open detection is enabled, if transfer the load off from the generator, fail to transfer detection starts while breaker open outputting after open delay, and when detection time is over, if breaker fails to open, generator will not be closed, otherwise, breaker opened; if transfer the load onto generator, Fail to Transfer Detection starts while breaker close outputting after close delay, and when detection time is over, if breaker fails to close, generator will not be opened, otherwise, breaker is closed (if fail to transfer warning enabled, alarms will be initiated if fail to C/O).

When breaker open detection is disabled, if transfer the load off from the generator, generator will be opened after open delay; if transfer the load onto generator, Fail to Transfer Detection starts while breaker close outputting after close delay, and when detection time is over, if breaker fails to close, it will wait for next close signal, otherwise, breaker is closed (if fail to transfer warning enabled, alarms will be initiated if fail to C/O).

b) If input port not configured as close status auxiliary input

If transfer the load onto generator, close gen will output; if transfer the load off from generator, open gen will output

▲NOTE:

- 1) If ATS without neutral position, breakers open detection should be disabled.
- 2) If ATS with neutral position, breakers open detection can be enabled or disabled (please configured the breaker open output if enabled)
- 3) If used with AC contactors, enabled breakers open detection will be recommended.

6 PROTECTION

6.1 WARNINGS

When controllers detects the warning alarms, alarm only and not stop the genset.

Table 5 - Warning Alarms Types

No.	Type	Description
1	Gen. Over Speed	When the controller detects that the speed of genset exceeds the pre-set value, it will initiate a warning alarm.
2	Gen. Under Speed	When the controller detects that the speed of genset falls below the pre-set value, it will initiate a warning alarm.
3	Loss of Speed Signal	When the controller detects that the speed of genset is zero and action select "Warning", it will initiate a warning alarm.
4	Gen. Over Frequency	When the controller detects that the frequency of genset exceeds the pre-set value, it will initiate a warning alarm.
5	Gen. Under Frequency	When the controller detects that the frequency of genset falls below the pre-set value, it will initiate a warning alarm.
6	Gen. Over Voltage	When the controller detects that the voltage of genset exceeds the pre-set value, it will initiate a warning alarm.
7	Gen. Under Voltage	When the controller detects that the voltage of genset falls below the pre-set value, it will initiate a warning alarm.
8	Gen. Over Current	When the controller detects that the current of genset exceeds the pre-set value, it will initiate a warning alarm.
9	Failed to Stop	If engine does not stop completely when fail to stop delay expired, it will initiate a warning alarm.
10	Charge Alt Fail	When the controller detects that the voltage of charger falls below the pre-set value, it will initiate a warning alarm.
11	Battery High Voltage	When the controller detects that the battery voltage of genset exceeds the pre-set value, it will initiate a warning alarm.
12	Battery Low Voltage	When the controller detects that the battery voltage of genset falls below the pre-set value, it will initiate a warning alarm.
13	Maintenance Time Due	When maintenance countdown is zero and action select "Warning", it will initiate a warning alarm.
14	Reverse Power	When controller detects that the reverse power value (power is negative) of genset exceeds the pre-set value, and action type select "Warning", it will initiate a warning alarm.
15	Over Power	When controller detects that the power value (power is positive) of genset exceeds the pre-set value, and action type select "Warning", it will initiate a warning alarm.
16	Gen. Loss of Phase	When controller detects that the phase of generator is loss, it will initiate a warning alarm.
17	Gen. Reverse Phase	When controller detects that the phase sequence of generator is wrong, it will initiate a warning alarm.
18	Breaker Switch Fail	When controller detects that the breaker is fail to close/open (when the warning is enabled), it will initiate a warning alarm.



No.	Type	Description
19	Temp. Sensor Open Circuit	When controller detects that the temperature sensor is open circuit and action select "Warning", it will initiate a warning alarm.
20	High Temp. Warning	When controller detects that the temperature is higher than the pre-set value, it will initiate a warning alarm.
21	Low Temp. Warning	When controller detects that the temperature is lower than the pre-set value, it will initiate a warning alarm.
22	Oil Pressure Sensor Open Circuit	When controller detects that sensor is open circuit, and action type select "Warning", it will initiate a warning alarm.
23	Low Oil Pressure Warning	When controller detects that the oil pressure value falls below the pre-set value, it will initiate a warning alarm.
24	Level Sensor Open Circuit	When controller detects that sensor is open circuit, and action type select "Warning", it will initiate a warning alarm.
25	Low Level Warning	When controller detects that the liquid level value falls below the pre-set value, it will initiate a warning alarm.
26	Config. Sensor 1 Open Circuit	When controller detects that sensor is open circuit, and action type is select "Warning", it will initiate a warning alarm.
27	Config. Sensor 1 High	When controller detects that the sensor value exceeds the pre-set upper limit warning value, it will initiate a warning alarm.
28	Config. Sensor 1 Low	When controller detects that the sensor value falls below the pre-set lower limit warning value, it will initiate a warning alarm.
29	Config. Sensor 2 Open Circuit	When controller detects that sensor is open circuit, and action type is select "Warning", it will initiate a warning alarm.
30	Config. Sensor 2 High	When controller detects that the sensor value exceeds the pre-set upper limit warning value, it will initiate a warning alarm.
31	Config. Sensor 2 Low	When controller detects that the sensor value falls below the pre-set lower limit warning value, it will initiate a warning alarm.
32	Input Warning	When digital input port configured as "Warning", and it is active, controller will initiate a warning alarm.
33	Cycle Start Communication Fail Warning	When two gensets, which during in cycle start status, fail to communicate, controller will initiate a warning alarm.

6.2 SHUTDOWN ALARM

When controller detects shutdown alarms, it will send signals to stop the generator and the corresponding alarm information will be displayed on LCD.

Table 6 - Shutdown Alarms

No.	Type	Description
1	Emergency Stop	When controller detects emergency stop signals, it will send stop signals.
2	Over Speed	When controller detects the speed value is higher than the set value, it will send stop signals.
3	Under Speed	When controller detects the speed value is lower than the set value, it will send stop signals.
4	Loss of Speed Signal	When controller detects speed value equals to 0, and action select "Shutdown", it will send stop signals.
5	Over Frequency	When controller detects the frequency value is higher than the set value, it will send stop signals.
6	Under Frequency	When controller detects the frequency value is lower than the set value, it will send stop signals.
7	Gen. Over Voltage	When controller detects the voltage value of genset is higher than the set value, it will send stop signals.
8	Gen. Under Voltage	When controller detects the voltage value of genset is lower than the set value, it will send stop signals.
9	Failed to Start	If genset start failure within setting of start times, controller will send stop signals.
10	Gen. Over Current	When controller detects the current value is higher than the set value and action select "Shutdown", it will send stop signals.
11	Maintenance Time Due	When maintenance time countdown equals to 0, and action select "Shutdown", it will send stop signals.
12	Reverse Power Shutdown	When controller detects that the reverse power value (power is negative) of genset exceeds the pre-set value, and action type select "Shutdown", it will send stop signals.
13	Over Power Shutdown	When controller detects that the power value (power is positive) of generator-set exceeds the pre-set value, and action type select "Shutdown", it will send stop signals.
14	Temp. Sensor Open Circuit	When controller detects sensor is open circuit, and the action select "shutdown", it will send stop signals.
15	High Temp. Shutdown	When controller detects temperature of water/cylinder is higher than the set value, it will send stop signals.
16	Oil Pressure Sensor Open Circuit	When controller detects sensor is open circuit, and the action select "shutdown", it will send stop signals.



No.	Type	Description
17	Low Oil Pressure Shutdown	When controller detects oil pressure is lower than the set value, it will send stop signals.
18	Level Sensor Open Circuit	When controller detects sensor is open circuit, and the action select "shutdown", it will send stop signals.
19	Low Level Shutdown	When controller detects liquid level is lower than the set value, it will send stop signals.
20	Config. Sensor 1 Open Circuit	When controller detects that sensor is open circuit, and action type is select "Shutdown", it will send stop signals.
21	Config. Sensor 1 High	When controller detects that the sensor value exceeds the pre-set upper limit shutdown value, it will send stop signals.
22	Config. Sensor 1 Low	When controller detects that the sensor value falls below the pre-set lower limit shutdown value, it will send stop signals.
23	Config. Sensor 2 Open Circuit	When controller detects that sensor is open circuit, and action type is select "Shutdown", it will send stop signals.
24	Config. Sensor 2 High	When controller detects that the sensor value exceeds the pre-set upper limit shutdown value, it will send stop signals.
25	Config. Sensor 2 Low	When controller detects that the sensor value falls below the pre-set lower limit shutdown value, it will send stop signals.
26	Input Alarm Shutdown	When digital input port configured as "Shutdown", and it is active, controller will send stop signals.

SmartGen

6.3 TRIP AND STOP ALARM

When controller detects trip and stop alarms, it will immediately disconnect the generator closing signals and engine will shut down after high-speed cooling.

Table 7 - Trip and Stop Alarms

No.	Type	Description
1	Over Current	When controller detects the current value of genset is higher than the set value and action select "Trip and Stop", it will send trip and stop signals.
2	Maintenance Time Due	When maintenance time countdown equals to 0, and action select "Trip and Stop", it will send trip stop signals.
3	Reverse Power	When controller detects that the reverse power value (power is negative) of genset exceeds the pre-set value, and action type select "Trip and Stop", it will send trip and stop signals.
4	Over Power	When controller detects that the power value (power is positive) of genset exceeds the pre-set value, and action type select "Trip and Stop", it will send trip and stop signals.
5	Input Trip and Stop	When input port configured as "Trip and Stop", and it is active, controller will send trip and stop signals.

6.4 TRIP ALARM

When controller detects trip alarms, it will immediately disconnect the generator closing signals and genset does not shut down.

Table 8 - Trip Alarms

No.	Type	Description
1	Over Current	When controller detects the current value of genset is higher than the set value and action select "Trip", it will send trip signals.
2	Reverse Power	When controller detects that the reverse power value (power is negative) of genset exceeds the pre-set value, and action type select "Trip", it will send trip signals.
3	Over Power	When controller detects that the power value (power is positive) of genset exceeds the pre-set value, and action type select "Trip", it will send trip signals.
4	Input Trip	When input port configured as "Trip", and it is active, controller will send trip signals.

7 WIRINGS CONNECTION

Compared with HGM7120N, HGM7110N is missing one mains voltage three-phase input terminal. HGM7120N controller back panel is as follows:

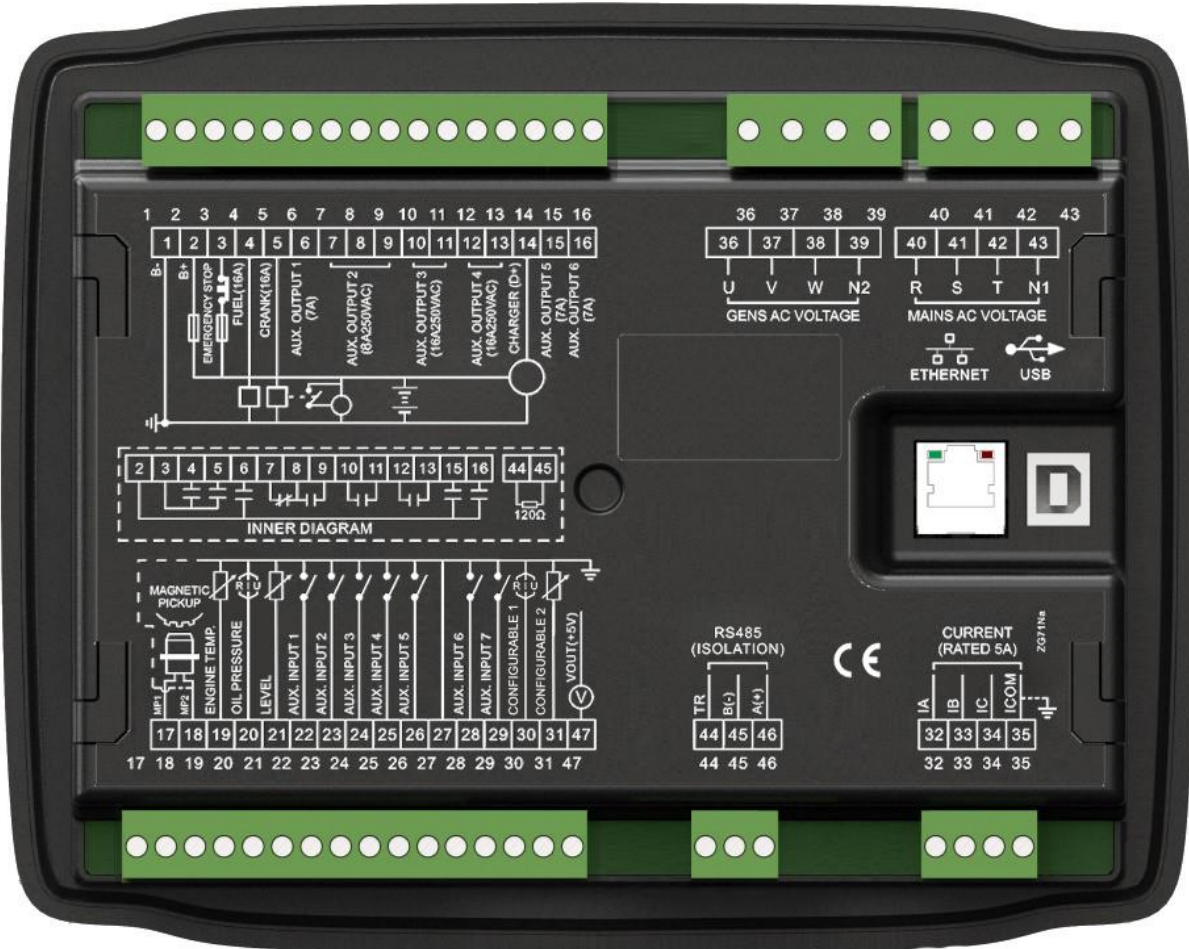

Figure 3 - HGM7120N Back Panel

Table 9 - Terminal Wiring Connection

No.	Function	Cable Size	Remarks
1	B-	2.5mm ²	Connected with negative of starter battery
2	B+	2.5mm ²	Connected with positive of starter battery. If wire length is over 30m, better to double wires in parallel. Max. 20A fuse is recommended.
3	Emergency Stop	2.5mm ²	Connect emergency stop button with B+.
4	Fuel (16A)	1.5mm ²	B+ is supplied by No.3 terminal, rated 16A.
5	Crank (16A)	1.5mm ²	B+ is supplied by No.3 terminal, rated 16A. Connect with starting coil of starter.
6	Aux. Output 1 (7A)	1.5mm ²	B+ is supplied by No.2 terminal, rated 7A.
7	Aux. Output 2 (8A 250VAC)	1.5 mm ²	Normally close output, rated 8A.
8			Relay common port



No.	Function	Cable Size	Remarks	
9			Normally open output, rated 8A.	
10	Aux. Output 3(16A 250VAC)	2.5 mm ²	Relay normally open volt free contact, rated 16A, volt free contact output.	
11				
12	Aux. Output 4(16A 250VAC)	2.5 mm ²		
13				
14	Charger(D+)	1.0mm ²	Connected with charger starter's D+ (WL) terminals. Being hang up If there is no this terminal.	
15	Aux. Output 5(7A)	1.5 mm ²	B+ is supplied by No.2 terminal, rated 7A	Details see Table 11
16	Aux. Output 6(7A)	1.5 mm ²		
17	Speed Sensor Input		Connect with speed sensor, shielded wire is recommended.	
18	Speed sensor input, battery negative electrode has been connected to the inside of controller.			
19	Engine Temp.	Connected with temperature sensor		Details to see table 13
20	Oil Pressure	Connected with pressure sensor		
21	Fuel Level	Connected with fuel level sensor		
22	Aux. Input 1	1.0mm ²	Ground connected is active (B-)	Details to see table 12
23	Aux. Input 2	1.0mm ²	Ground connected is active (B-)	
24	Aux. Input 3	1.0mm ²	Ground connected is active (B-)	
25	Aux. Input 4	1.0mm ²	Ground connected is active (B-)	
26	Aux. Input 5	1.0mm ²	Ground connected is active (B-)	
27	Sensor Common Port	Sensor common port, battery negative electrode has been connected to the inside of controller.		
28	Aux. Input 6	1.0mm ²	Ground connected is active (B-)	Details to see table 12
29	Aux. Input 7	1.0mm ²	Ground connected is active (B-)	
30	Configurable Sensor 1	Connected with temp/pressure/fuel level sensor.		Details to see table 13
31	Configurable Sensor 2			
32	CT A-phase Monitoring Input	1.5mm ²	Outside connected to secondary coil of CT (5A rated).	
33	CT B-phase Monitoring Input	1.5mm ²	Outside connected to secondary coil of CT (5A rated).	
34	CT C-phase Monitoring Input	1.5mm ²	Outside connected to secondary coil of CT (5A rated).	
35	CT Common Port	1.5mm ²	Details to see the following installation description.	
36	Gen U-phase Voltage Monitoring Input	1.5mm ²	Connected to U-phase output of genset (2A fuse recommended).	
37	Gen V-phase Voltage Monitoring Input	1.0mm ²	Connected to V-phase output of genset (2A fuse recommended).	



No.	Function	Cable Size	Remarks
38	Gen W-phase Voltage Monitoring Input	1.0mm ²	Connected to W-phase output of genset (2A fuse recommended).
39	Gen N2-line Input	1.0mm ²	Connected to N-line output of genset.
40	Mains R-phase Voltage Monitoring Input	1.0mm ²	Connected to R-phase of mains (2A fuse recommended) (HGM7110N without)
41	Mains S-phase voltage monitoring input	1.0mm ²	Connected to S-phase of mains (2A fuse recommended). (HGM7110N without)
42	Mains T-phase voltage monitoring input	1.0mm ²	Connected to T-phase of mains (2A fuse recommended). (HGM7110N without)
43	Mains line N1 Input	1.0mm ²	Connected to N-line of mains. (HGM7110N without)
44	RS485 Common Ground	0.5mm ²	120Ω shielded wire is recommended with single end ground.
45	RS485-	0.5mm ²	
46	RS485+	0.5mm ²	
47	VOUT(+5V)	0.5mm ²	Output DC +5V.

▲ NOTE: USB ports in controller rear panel are programmable parameter ports, user can directly configure the controller via PC.

▲ NOTE: ETHERNET port in controller rear panel is network monitoring port, user can directly monitor the controller via PC.

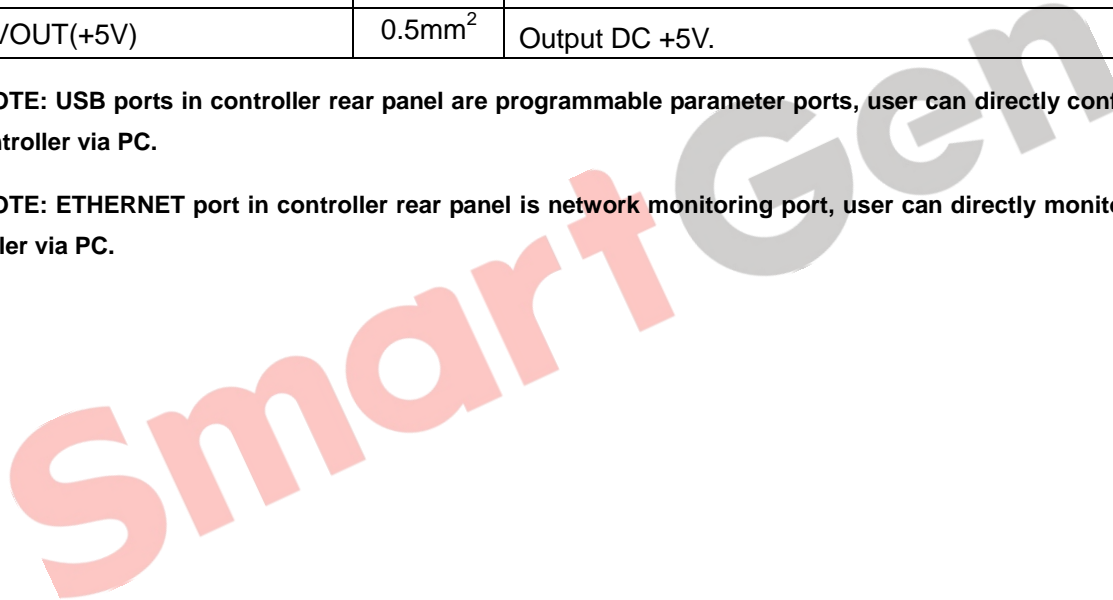

8 SCOPES AND DEFINITIONS OF PROGRAMMABLE PARAMETERS

8.1 CONTENTS AND SCOPES OF PARAMETERS

Table 10 - Parameters Settings and Scope

No.	Items	Range	Default	Description
Mains				
1	AC System	(0-3)	0	0: 3P4W; 1: 3P3W 2: 2P3W 3: 1P2W
2	Mains Voltage Rated	(30-30000)V	230	Provide standard for judging whether mains over/under voltage or not; if used voltage transformer, this value is primary voltage of transformer.
3	Mains Frequency Rated	(10.0-75.0)Hz	50.0	Provide standard for judging whether mains over/under frequency or not.
4	Mains Delay Normal	(0-3600)s	10	The time from mains abnormal to normal.
5	Mains Time Abnormal	(0-3600)s	5	The time from mains normal to abnormal.
6	Mains Voltage Transformer (PT)	(0-1)	0	0: Disabled; 1: Enabled
7	Mains Over Voltage	(0-200)%	120	The setting value is mains rated voltage percentage; return value and delay value also can be set.
8	Mains Under Voltage	(0-200)%	80	
9	Mains Frequency Over	(0-200)%	Disabled	The setting value is mains rated frequency percentage; return value and delay value also can be set.
10	Mains Frequency Under	(0-200)%	Disabled	
11	Mains Loss of Phase Check	(0-1)	1	0: Disabled; 1: Enabled
12	Mains Reverse Phase	(0-1)	1	
Timers				
1	Start Delay	(0-3600)s	1	Time from mains abnormal or remote start signal is active to start gen-set.
2	Return Delay	(0-3600)s	1	Time from mains normal or remote start signal is deactivated to genset stop.
3	Preheat Delay	(0-3600)s	0	Power-on time of heater plug before starter is powered up.
4	Cranking Time	(3-60)s	8	Each starter power-on time.
5	Crank Rest Time	(3-60)s	10	The waiting time before second power up when engine starts fail.
6	Safety On Time	(0-3600)s	10	Alarms for low oil pressure, high temp, under speed, under frequency/voltage, charge alt failure are deactivated.
7	Start Idle Time	(0-3600)s	0	Idle speed running time when gen-set start up.



No.	Items	Range	Default	Description
8	Warming Up Time	(0-3600)s	10	Warming time between gen-set switch on and high speed running.
9	Cooling Time	(0-3600)s	10	Radiating time before gen-set stop, after it unloads.
10	Stop Idle Time	(0-3600)s	0	Idle running time while gen-set closing down.
11	ETS Solenoid Hold	(0-3600)s	20	Stop electromagnet's power on time when gen-set is closing down.
12	Wait For Stop Time	(0-3600)s	0	When "ETS Solenoid Hold" is set as 0, it is the time between gen-set idle delay expired and stopped completely; When "ETS Solenoid Hold" is not 0, it is time between ETS hold delay expired and stopped.
13	After Stop Time	(0-3600)s	0	Time from gen-set stopped to standby.
Engine				
1	Engine Type	(0-39)	0	Default: conventional engine.
2	Flywheel Teeth	(1.0-300.0)	118	It is tooth number of the engine, which is used for judging starter crank disconnect conditions and inspecting engine speed. Details to see the following installation description.
3	Engine Rated Speed	(0-6000)RPM	1500	Provide standard for judging over/under speed and on-load speed.
4	Speed On-load	(0-100)%	90	The setting value is rated speed percentage. The controller detects it while gen-set preparing to take the load, if the speed is less than the on-load speed, gen-set will not enter the normal operation period.
5	Speed Signal Loss Delay	(0-3600)s	5	Time from the speed is detected as 0 to the action confirmed.
6	Speed Signal Loss Action	(0-1)	0	0: Warning; 1: Shutdown
7	Over Speed Shutdown	(0-200)%	114	The setting value is the percentage of rated speed, and delay value can be set.
8	Under Speed Shutdown	(0-200)%	80	
9	Over Warning Speed	(0-200)%	110	The setting value is the percentage of rated speed, return value and delay value can be set.
10	Under Warning Speed	(0-200)%	86	
11	Battery Rated Voltage	(0-60.0)V	24.0	Provide standard for judging battery over/under voltage.
12	Battery High Voltage Warning	(0-200)%	120	The setting value is the percentage of rated voltage, return value and delay value can be set.
13	Battery Low Voltage Warning	(0-200)%	85	



No.	Items	Range	Default	Description
14	Charge Alt Fail	(0-60.0)V	8.0	If the voltage of charger D+(WL) is lower than the setting value during gen-set normal running, controller will initiate fail to charge warning alarms.
15	Start Attempts	(1-10)times	3	Maximum crank times when engine starts fail. If reach this number, controller will send start failure signals.
16	Crank Disconnect Condition	(0-6)	2	Details please to see table 14 There are 3 cranking disconnect conditions, which can be used separately or together, aiming to disconnect starter motor with engine as soon as possible.
17	Frequency of Crank Disconnect	(0-200)%	24	The setting value is the percentage of rated frequency, when generator frequency is higher than the set value, starter will be disconnected. Details to see the following installation description.
18	Speed of Crank Disconnect	(0-200)%	24	The setting value is the percentage of the rated speed, when speed is higher than the setting value, starter will disconnect. Details to see the following installation description.
19	Oil Pressure of Crank Disconnect	(0-1000)kPa	200	When engine oil pressure is higher than the setting value, starter will disconnect. Details to see the following installation description.
20	Battery Low Voltage Start Enabled	(0-1)	0	0: Disabled; 1:Enabled
21	Battery Low Voltage Start Value	(1.0-60.0)V	10.0	It is the low-battery-start value. Active when in auto mode.
22	Battery Low Voltage Stop Value	(1.0-60.0)V	24.0	The shutdown value after low-battery-start and charged. Active when in auto mode.
23	Battery Low Voltage Start/Stop Delay	(0-3600)s	60	When battery voltage reached to engine start threshold, engine will start up after delay expired; when battery voltage reached to engine stop threshold, engine will stop after delay expired.
Generator				
1	Power System Supply	(0-3)	0	0: 3P4W; 1: 3P3W 2: 2P3W 3: 1P2W
2	Engine Poles	(2-64)	4	It is the number of engine poles, which can help engine without installing speed sensor to calculate engine speed.
3	Rated Voltage	(30-30000)V	230	Provide standard for judging gen over/under voltage, and on-load voltage. If voltage transformer is used, this value is transformer primary voltage.



No.	Items	Range	Default	Description
4	Voltage On-load	(0-200)%	85	The setting value is rated voltage percentage. The controller detects it while gen-set preparing to take the load, if voltage is less than the on-load voltage, gen-set will not enter normal operation period.
5	Rated Frequency	(10.0-600.0) Hz	50.0	Provide standard for judging over/under frequency and on-load frequency.
6	Frequency On-load	(0-200)%	85	The setting value is rated frequency percentage. The controller detects it while gen-set preparing to take the load, if frequency is less than the on-load frequency, gen-set will not enter normal operation period.
7	Voltage Transformer (PT)	(0-1)	0	0: Disabled; 1: Enabled
8	Gen. Over Voltage Shutdown	(0-200)%	120	The setting values are rated voltage percentage of generator, and delay value can be set.
9	Gen. Under Voltage Shutdown	(0-200)%	80	
10	Gen. Over Frequency Shutdown	(0-200)%	114	The setting values are rated frequency percentage of generator, and delay value can be set.
11	Gen. Under Frequency Shutdown	(0-200)%	80	
12	Gen. Over Voltage Warning	(0-200)%	110	The setting values are rated voltage percentage of generator, and return value and delay value can be set.
13	Gen. Under Voltage Warning	(0-200)%	84	
14	Gen. Over Frequency Warning	(0-200)%	110	The setting values are rated frequency percentage of generator, and return value and delay value can be set.
15	Gen. Under Frequency Warning	(0-200)%	84	
16	Gen. Loss of Phase Check	(0-1)	1	0: Disabled; 1:Enabled
17	Gen. Reverse Phase Check	(0-1)	1	
Load				
1	Current Transformer Ratio	(5-6000)/5	500	It is the ratio of external connected current transformer.
2	Rated Current	(5-6000)A	500	It is the rated current of generator, which is used as the standard for load current.
3	Rated Power	(0-6000)kW	276	It is the rated power of generator, which is used as the standard for load current.
4	Over Current Enable	(0-200)%	120	The setting value is the percentage of rated full-load current, and delay value can be set as DMT or IDMT.



No.	Items	Range	Default	Description
5	Over Power Setting	(0-1)	0	0: Disabled; 1: Enabled
6	Reverse Power Setting	(0-1)	0	0: Disabled; 1: Enabled
Switch				
1	Switching Time	(0-7200)s	5	Time from open mains to close generator or from open generator to close mains.
2	Close Delay	(0-20.0)s	5.0	Pulse width of mains closed and generator closed; 0s stands for constant output.
3	Open Delay	(0-20.0)s	3.0	Pulse width of open mains and open generator.
4	Switching Detection Time	(0-20.0)s	5.0	It is the time to detect auxiliary contactor after ATS switching.
5	Switch Failure Warning Enabled	(0-1)	0	0: Disabled; 1: Enabled
6	Open Detection Enabled	(0-1)	0	
7	Immediately Trip when Mains Dropout	(0-1)	1	0: Disabled; 1: Enabled
Module				
1	Power On Mode	(0-2)	0	0: Stop Mode; 1: Manual Mode; 2: Auto Mode
2	Communication Address	(1-254)	1	Controller address while in remote monitoring status.
3	Communication Stop-bit Setting	(0-1)	1	0: 2-bit stop bit; 1: 1-bit stop bit
4	Language Selection	(0-2)	0	0: Simplified Chinese; 1: English; 2: Other
5	Password Setting	(0-65535)	00318	This password used to enter into advanced parameter setting.
6	Backlight Time	(0-3600) s	300	When it is 0s, LCD always light.
Schedule & Maintenance				
1	Scheduled Start Setting	(0-1)	0	0: Disabled; 1: Enabled
2	Scheduled Not Run Setting	(0-1)	0	0: Disabled; 1: Enabled
3	Maintenance Setting	(0-1)	0	0: Disabled; 1: Enabled
Analog Sensors				
Temperature Sensor				
1	Curve Type	(0-15)	7	SGX. Detail to see Table 13
2	Open Circuit Action	(0-2)	0	0: Warning; 1: Shutdown; 2: None
3	High Temp Shutdown Setting	(0-300)°C	98	When temperature value of external connected temperature sensor is higher than the setting point, controller will initiate high temperature shutdown alarm (judgment only starts after safety on delay expired). Delay value can be set.



No.	Items	Range	Default	Description
4	High Temp Warning Setting	(0-300)°C	95	When temperature value of external connected temperature sensor is higher than the setting point, controller will initiate high temperature warning alarm (judgment only starts after safety on delay expired). Return value and delay value can be set.
5	Low Temp Warning Setting	(0-1)	0	0: Disabled; 1: Enabled
Oil Pressure Sensor				
1	Curve Type	(0-15)	7	SGX. Details to see table 13.
2	Open Circuit Action	(0-2)	0	0: Warning; 1: Shutdown; 2: None
3	Low Oil Pressure Shutdown Setting	(0-1000)kPa	103	When pressure value of external connected oil pressure sensor is lower than the setting point, controller will initiate low oil pressure shutdown alarm (judgment only starts after safety on delay expired). Delay value can be set.
4	Low Oil Pressure Warning Setting	(0-1000)kPa	124	When pressure value of external connected oil pressure sensor is lower than the setting point, controller will initiate low oil pressure warning alarm (judgment only starts after safety on delay expired). Return value and delay value can be set.
5	Sensor Type	(0-2)	0	0: Resistor type; 1: Current type; 2: Voltage type.
Level Sensor				
1	Curve Type	(0-15)	4	SGH. Details to see table 13.
2	Open Circuit Action	(0-2)	0	0: Warning; 1: Shutdown; 2: None
3	Low Level Warning	(0-300)%	10	When the value of external connected fuel level sensor is lower than the setting point, controller will initiate low liquid level warning alarm (always judge). Return value and delay value can be set.
4	Low Level Shutdown	(0-300)%	8	When the value of external connected level sensor is lower than the setting point, controller will initiate low liquid level shutdown alarm (always judge). Delay value can be set.
Flexible Sensor 1				
1	Flexible Sensor 1 Setting	(0-3)	0	0: Not Used; 1:Temperature Sensor; 2:Pressure Sensor; 3:Fuel Level Sensor
2	Sensor Type	(0-2)	0	0: Resistor type; 1: Current type; 2: Voltage type.
Flexible Sensor 2				
1	Flexible Sensor 2 Setting	(0-3)	0	0: Not Used; 1:Temperature Sensor; 2:Pressure Sensor; 3:Fuel Level Sensor
Digital Inputs				
Digital Input 1				

No.	Items	Range	Default	Description
1	Content Setting	(0-50)	28	Remote start (on-load). Details to see table 12
2	Active Type	(0-1)	0	0: Close; 1: Open
Digital Input 2				
1	Content Setting	(0-50)	26	High temperature shutdown input. Details to see table 12
2	Active Type	(0-1)	0	0: Close; 1: Open
Digital Input 3				
1	Content Setting	(0-50)	27	Low oil pressure shutdown input. Details to see table 12
2	Active Type	(0-1)	0	0: Close; 1: Open
Digital Input 4				
1	Content Setting	(0-50)	0	User defined. Details to see table 12
2	Active Type	(0-1)	0	0: Close; 1: Open
3	Active Range	(0-3)	2	0: From safety on delay; 1: From crank; 2: Always; 3:Never
4	Active Action	(0-4)	0	0: Warning; 1: Shutdown; 2: Trip and Stop; 3: Trip; 4: Indication.
5	Active Delay	(0-20.0)s	2.0	Time from detecting input port is active to confirmation.
6	Description			LCD displays corresponding content when input port is active.
Digital Input 5				
1	Content Setting	(0-50)	0	User defined. Details to see table 12.
2	Active Type	(0-1)	0	0: Close; 1: Open
3	Active Range	(0-3)	2	0: From safety on delay; 1: From crank; 2: Always; 3:Never
4	Active Action	(0-4)	1	0: Warning; 1: Shutdown; 2: Trip and Stop; 3: Trip; 4: Indication.
5	Active Delay	(0-20.0)s	2.0	Time from detecting input port is active to confirmation.
6	Description			LCD displays corresponding content when input port is active.
Digital Input 6				
1	Content Setting	(0-50)	0	User defined. Details to see table 12.
2	Active Type	(0-1)	0	0: Close; 1: Open
3	Active Range	(0-3)	2	0: From safety on delay; 1: From crank; 2: Always; 3:Never
4	Active Action	(0-4)	2	0: Warning; 1: Shutdown; 2: Trip and Stop; 3: Trip; 4: Indication.
5	Active Delay	(0-20.0)s	2.0	Time from detecting input port is active to confirmation.
6	Description			LCD displays corresponding content when input port is active.
Digital Input 7				
1	Content Setting	(0-50)	0	User defined. Details to see table 12.
2	Active Type	(0-1)	0	0: Close; 1: Open



No.	Items	Range	Default	Description
3	Active Range	(0-3)	2	0: From safety on delay; 1: From crank; 2: Always; 3:Never
4	Active Action	(0-4)	3	0: Warning; 1: Shutdown; 2: Trip and Stop; 3: Trip; 4: Indication.
5	Active Delay	(0-20.0)s	2.0	Time from detecting input port is active to confirmation.
6	Description			LCD displays corresponding content when input port is active.
Relay Outputs				
Relay Output 1				
1	Content Setting	(0-239)	1	User defined time period output 1(default: output in preheat period). Details to see table 11.
2	Output Type	(0-1)	0	0: Normally open; 1: Normally close.
Relay Output 2				
1	Content Setting	(0-239)	35	Idle speed control. Details to see table 11.
2	Output Type	(0-1)	0	0: Normally open; 1: Normally close.
Relay Output 3				
1	Content Setting	(0-239)	29	Close generator output. Details to see table 11.
2	Output Type	(0-1)	0	0: Normally open; 1: Normally close.
Relay Output 4				
1	Content Setting	(0-239)	31	Close mains output. Details to see table 11.
2	Output Type	(0-1)	0	0: Normally open; 1: Normally close.
Relay Output 5				
1	Content Setting	(0-239)	38	ETS control. Details to see table 11.
2	Output Type	(0-1)	0	0: Normally open; 1: Normally close.
Relay Output 6				
1	Content Setting	(0-239)	48	Common alarm. Details to see table 11.
2	Output Type	(0-1)	0	0: Normally open; 1: Normally close.
Cycle Start Settings				
1	Cycle Start Enabled	(0-1)	0	0: Disabled; 1: Enabled
2	Priority Selection	(0-1)	0	0: standby unit (slave unit); 1: Main unit
3	Main Unit Running Time (minute)	(0,1440)	720	
4	Standby Unit Running Time (minute)	(0,1440)	720	
IP				
1	Ethernet Enabled	(0-1)	0	0: Disabled; 1: Enabled
2	DHPC Enabled	(0-1)	1	0: Disabled; 1: Enabled Automatically obtain IP address.



No.	Items	Range	Default	Description
3	IP Address	(0-255)	192.168.0.101	All changes of Ethernet (like IP address, subnet mask and etc.) are active after controller repower-up.
4	Subnet Mask	(0-255)	255.255.255.0	
5	Gateway IP	(0-255)	192.168.0.2	
6	DNS Address	(0-255)	211.138.24.66	
7	MAC Address	(0-255)		
8	TCPMODBUS Comm. Enabled	(0-1)	0	0: Disabled; 1: Enabled
9	Cloud Monitoring Comm. Enabled	(0-1)	0	0: Disabled; 1: Enabled
Gateway & Cloud Server Settings				
1	Site Name	(0-65535)		20 characters/letters/numbers
2	URL Server	(0-65535)	cm.smartgen.com.cn	
3	Server Port	(0-65535)	81	
4	Module Password	(0-65535)	123456	16 characters
5	Longitude Setting	(-180-180)°	113.33	Location of gen-set controller and altitude information need to manually input.
6	Latitude Setting	(-90-90)°	34.48	
7	Altitude Setting	(-9999.9-9999.9)	100.0	
8	Real-data Interval	(1-20)s	5	

8.2 DEFINITION CONTENT OF PROGRAMMABLE OUTPUT PORTS 1~6

Table 11 - Programmable Output Ports 1~6

No.	Type	Description
0	Not Used	
1	Custom Period 1	Details of function description please to see the following content.
2	Custom Period 2	
3	Custom Period 3	
4	Custom Period 4	
5	Custom Period 5	
6	Custom Period 6	
7	Custom Combined 1	
8	Custom Combined 2	
9	Custom Combined 3	
10	Custom Combined 4	
11	Custom Combined 5	
12	Custom Combined 6	
13	Reserved	
14	Reserved	
15	Reserved	
16	Reserved	
17	Air Flap Control	It is activate when over speed shutdown and emergency shutdown alarms appear, which can turn off the engine intake.
18	Audible Alarm	It is activate when warning, shutdown and electrical trip alarms appear (Annunciator can be connected externally); if



No.	Type	Description
		input port configured as “Mute Alarms” and it is active, audible alarm can be inhibited.
19	Louver Control	Activate from starting generator and disconnect after generator stopped completely.
20	Fuel Pump Control	Fuel pump of fuel level sensor controlling the upper/lower limit to control its action.
21	Heater Control	Heater of temperature sensor controlling the upper/lower limit to control its action.
22	Cooler Control	Cooler of temperature sensor controlling the upper/lower limit to control its action.
23	Pre- fuel	Activate from cranking to safety on period.
24	Excite Generator	Output while in cranking, if there is no generator frequency in high speed running status, then output again for 2s.
25	Pre-lubricate Output	Activate from pre-heat to safety on period.
26	Remote PC Output	Through communication (PC) to control this output port.
27	Reserved	
28	Reserved	
29	Close Generator	Controlling breaker to make generator takes on load.
30	Open Breaker	Controlling breaker to ramp off load.
31	Close Mains	Controlling breaker to make mains take on load.
32	Reserved	
33	Starter Relay Output	
34	Fuel Relay Output	Activate when generator start, and disconnect while waiting for stop.
35	Idle Control	This function is used for engine that has idle speed function. It closes before starting up and opens when controller enters into hi-speed warming up; it Closes during stop idle process and opens when stop is completed.
36	Raise Speed	Activate in high-speed warming up period.
37	Drop Speed	Activate from generator stop idling to waiting for stop.
38	ETS Control	Suitable for gen-set with electromagnet and will active after “stop idle delay”. It is deactivated when the “ETS Solenoid delay” expires.
39	Pulse Drop Speed	
40	Reserved	
41	Reserved	
42	Pulse Raise Speed	
43	Crank Success	Connect when detect crank disconnect signals been.
44	Generator OK	Activate when generator is OK.
45	Generator Available	Activate from generator normal running to high-speed cooling.
46	Mains OK	Activate when mains is OK.
47	Loading Speed Output	
48	Common Alarm	Activate when common warning, common shutdown and common trip alarms occurred.



No.	Type	Description
49	Common Electrical Trip and Stop	Activate when common electrical trip and stop occurred.
50	Common Shutdown	Activate when common shutdown occurred.
51	Common Trip Alarm	Activate when common trip alarms occurred.
52	Common Warning Alarm	Activate when common warnings occurred.
53	Reserved	
54	Battery High Voltage	Activate when battery voltage is over too high.
55	Battery Low Voltage	Activate when battery voltage is over too low.
56	Charge Alt Fail	Activate when generator fail to charge alarms occurred.
57	Reserved	
58	Reserved	
59	Reserved	
60	ECU Warning Alarm	It is indicate that ECU sent a warning alarm signal.
61	ECU Shutdown Alarm	It is indicate that ECU sent a shutdown alarm signal.
62	Reserved	
63	Reserved	
64	Reserved	
65	Reserved	
66	Reserved	
67	Reserved	
68	Reserved	
69	Digital Input 1 Active	Activate when input port 1 is active.
70	Digital Input 2 Active	Activate when input port 2 is active.
71	Digital Input 3 Active	Activate when input port 3 is active.
72	Digital Input 4 Active	Activate when input port 4 is active.
73	Digital Input 5 Active	Activate when input port 5 is active.
74	Digital Input 6 Active	Activate when input port 6 is active.
75	Digital Input 7 Active	Activate when input port 7 is active.
76-98	Reserved	
99	Emergency Stop Alarm	Activate when emergency stop alarm occurred.
100	Failed to Start Alarm	Activate when fail to start alarm occurred.
101	Failed to Stop Alarm	Activate when fail to stop warning alarm occurred.
102	Under Speed Warning	Activate when engine under speed warning alarm occurred.
103	Under Speed Shutdown	Activate when engine under speed shutdown alarms occurred.
104	Over Speed Warning	Activate when engine over speed warning alarm occurred.
105	Over Speed Shutdown	Activate when engine over speed shutdown alarms occurred.
106	Reserved	
107	Reserved	
108	Reserved	
109	Gen. Over Freq Warning	Activate when generator over frequency warning alarm occurred.



No.	Type	Description
110	Gen. Over Freq Shutdown	Activate when generator over frequency shutdown alarm occurred.
111	Gen. Over Voltage Warning	Activate when generator over voltage warning alarm occurred.
112	Gen. Over Volt Shutdown	Activate when generator over voltage shutdown alarm occurred.
113	Gen. Under Frequency Warning	Activate when generator under frequency warning alarm occurred.
114	Gen. Under Frequency Shutdown	Activate when generator under frequency shutdown alarm occurred.
115	Gen. Under Voltage Warning	Activate when generator under voltage warning alarm occurred.
116	Gen. Under Voltage Shutdown	Activate when generator under voltage shutdown alarm occurred.
117	Gen. Loss of Phase	Activate when generator loss of phase alarm occurred.
118	Gen. Reverse Phase	Activate when generator phase sequence wrong alarm occurred.
119	Reserved	
120	Over Power Alarm	
121	Reserved	
122	Reverse Power	Activate when controller detects that generator power is reversed.
123	Over Current Alarm	Activate when over current occurred.
124	Reserved	
125	Mains Inactive	
126	Mains Over Frequency	
127	Mains Over Voltage	
128	Mains Under Frequency	
129	Mains Under Voltage	
130	Mains Reverse Phase	
131	Mains Loss Of Phase	
132-138	Reserved	
139	High Temp Warning	Activate when high temperature warning alarms occurred.
140	Low Temp Warning	Activate when low temperature warning alarms occurred.
141	High Temp Shutdown Alarm	Activate when high temperature shutdown alarms occurred.
142	Reserved	
143	Low Oil Pressure Warning	Activate when low oil pressure warning alarms occurred.
144	Low Oil Pressure Shutdown	Activate when low oil pressure shutdown alarms occurred.
145	Oil Pressure Sensor Open Circuit	Activate when oil pressure open circuit alarms occurred.
146	Reserved	
147	Low Level Warning	Activate when low fuel level alarms occurred.



No.	Type	Description
148	Reserved	
149	Reserved	
150	Config. Sensor 1 High Warning	
151	Config. Sensor 1 Low Warning	
152	Config. Sensor 1 High Shutdown	
153	Config.Sensor 1 Low Shutdown	
154	Config. Sensor 2 High Warning	
155	Config. Sensor 2 Low Warning	
156	Config. Sensor 2 High Shutdown	
157	Config. Sensor 2 Low Shutdown	
158-229	Reserved	
230	System In Stop Mode	Activate when system in stop mode.
231	System In Manual Mode	Activate when system in manual mode.
232	Reserved	
233	System In Auto Mode	Activate when system in auto mode.
234	Generator On Load Indication	
235	Mains On Load Indication	
236	Reserved	
237	Reserved	
238	Reserved	
239	Reserved	

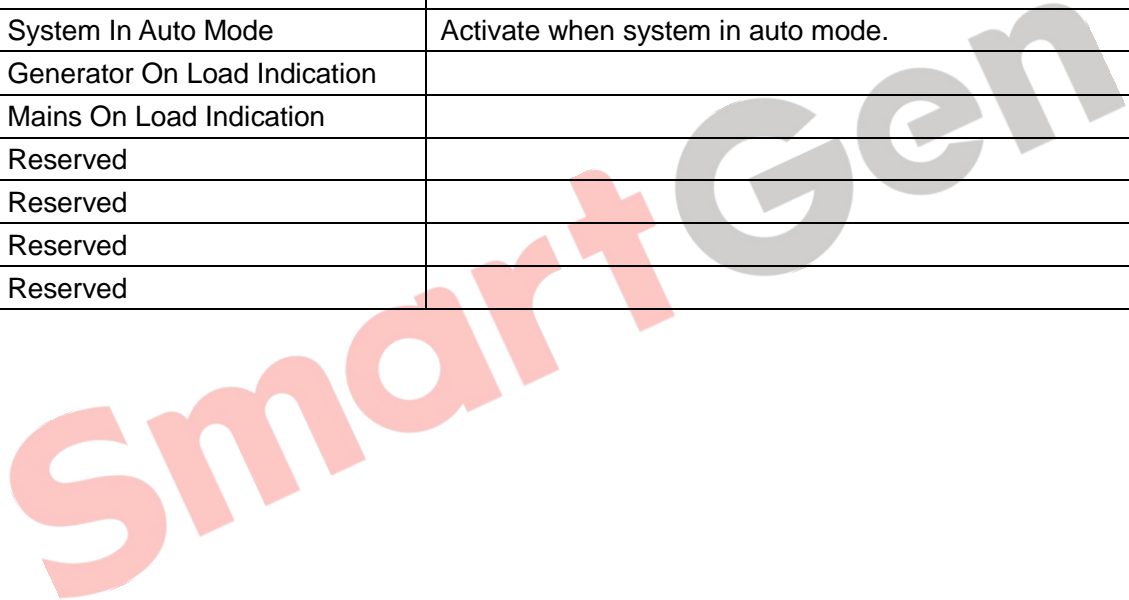

8.2.1. CUSTOM PERIOD OUTPUT

Defined Period output is composed by 2 parts, **period output S1** and **condition output S2**.



While **S1** and **S2** are **TRUE** synchronously, **OUTPUT**;

While **S1** or **S2** is **FALSE**, **NOT OUTPUT**.

Period output S1 can set generator's one or more period output freely, can set the delayed time and output time after enter into period.

Condition output S2 can set as any conditions in output ports.

▲NOTE: when delay time and output time both are 0 in period output S1, it is TRUE in this period.

▲NOTE: when select period is standby, it is cycle output and other periods are single output.

Example,

Output period: start

Delay output time: 2s

Output time: 3s

Condition output contents: output port 1 is active

Close when condition output active/inactive: close when active (disconnect when inactive);

Output port 1 active, after enter "starts time" and delay 2s, this defined period output is outputting, after 3s, stop outputting;

Output port 1 inactive, defined output period is not outputting.

8.2.2. CUSTOM COMBINED OUTPUT

Defined combination output is composed by 3 parts, condition output S1 or S2 and condition output S3.

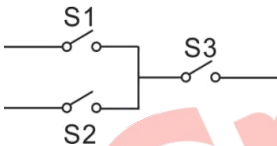

S1 or S2 is **TRUE**, while S3 is **TRUE**, Defined combination output is outputting;

S1 and S2 are **FALSE**, or S3 is **FALSE**, Defined combination output is not outputting.

▲NOTE: S1, S2, S3 can be set as any contents except for "defined combination output" in the output setting.

▲NOTE: 3 parts of defined combination output (S1, S2, and S3) couldn't include or recursively include themselves.

Example,

Contents of probably condition output S1: output port 1 is active;

Close when probably condition output S1 is active /inactive: close when active (disconnect when inactive);

Contents of probably condition output S2, output port 2 is active;

Close when probably condition output S2 is active /inactive: close when active (disconnect when inactive);

Contents of probably condition output S3: output port 3 is active;

Close when probably condition output S3 is active /inactive: close when active (disconnect when inactive);

When input port 1 active or input port 2 active, if input port 3 is active, Defined combination output is outputting; If input port 3 inactive, Defined combination output is not outputting;

When input port 1 inactive and input port 2 inactive, whatever input port 3 is active or not, Defined combination output is not outputting.



8.3 DEFINED CONTENTS OF CONFIGURABLE INPUT PORTS 1~7

Table 12 - Enable Programmable Inputs 1~7 (Ground connected is active (B-))

No	Items	Description
0	User Configured	Users can define content as bellows: Indication: only display without warning and shutdown. Warning: only warning without shutdown. Shutdown: alarm and shutdown immediately. Trip and stop: alarm, generator ramp-off load and stop after high-speed cooling. Trip: alarm, generator ramp-off load but not stop. Inactive: input doesn't work. Always active: input detects all the time. From crank: start detecting at the beginning of startup. From safety on: start detecting after safety on delay is expired.
1	Reserved	
2	Alarm Mute	When input is active, "Audible Alarm" output is inhibited.
3	Reset Alarm	When input is active, shutdown alarms and trip alarms can be reset.
4	Reserved	
5	Lamp Test	When input is active, all LED indicators are light.
6	Panel Lock	When input is active, all buttons on the panel are inactive except for , and displays on the right side of the first line of LCD status page.
7	Reserved	
8	Idle Control Mode	Under speed, under frequency and under voltage are not protected in this mode.
9	Inhibit Auto Stop	After generator is normal running in auto mode, when input is active, generator-set auto stop function is inhibited.
10	Inhibit Auto Start	After input is active in auto mode, generator-set auto start is inhibited.
11	Inhibit Scheduled Start	After input is active in auto mode, generator-set auto timing start gen-set is inhibited.
12	Master Select	Duty unit selection in cycle running.
13	Aux. Gen. Closed	Connecting the auxiliary contact of generator loading switch.
14	Inhibit Gen. Load	When input is active, gen-set will inhibit to close.
15	Aux Mains Closed	Connecting the auxiliary contact of mains loading switch.
16	Inhibit Mains Load	When input is active, mains will inhibit to close.
17	Auto Mode Input	When input is active, controller will enter into auto mode, and all buttons on the panel are inactive except for , and displays on the right side of the first line of LCD status page.
18	Auto Mode Invalid	When input is active, controller will not works in auto mode, key and "Simulate Auto Mode" key are unavailable.



No	Items	Description
19	Reserved	
20	Reserved	
21	Inhibit Alarm Shutdown	All shutdown alarms are inhibited except for emergency stop (sometimes called War Mode or Override Mode)
22	Instrument Mode	All outputs are inhibited in this mode.
23	Box Temp High Warning	
24	Reset Maintenance Time	When input is active, controller will reset maintenance time and date as pre-set values.
25	Low Level Shutdown	Connecting with sensor digital input.
26	High Temp Shutdown	Connecting with sensor digital input.
27	Low Oil Pressure Shutdown	Connecting with sensor digital input.
28	Remote Start (On-load)	When input is active in auto mode, gen-set will be started automatically, and then gen-set takes on load after normal running. When input is inactive, gen-set will be stopped automatically.
29	Remote Start (Off-load)	When input is active in auto mode, gen-set will be started automatically without taking load after normal running. When input is inactive, gen-set will be stopped automatically.
30	Aux Manual Start	When input is active in manual mode, gen-set will be started automatically. When input is inactive, gen-set will be stopped automatically.
31	Simulate Up Key	External Connecting a button to simulate key function on the panel.
32	Simulate Down Key	
33	Simulate Stop Key	
34	Simulate Manual Key	
35	Reserved	
36	Simulate Auto Key	
37	Simulate Start Key	
38	Simulate Gen C/O Key	
39	Simulate Mains C/O Key	
40	Reserved	
41	Reserved	
42	Reserved	
43	Simulate Set Key	
44	Reserved	
45	Simulate Mains OK	
46	Simulate Mains Fail	
47	Alternative Config 1 Active	When input port is active, alternative configuration is available. Alternative configuration can be set as different parameters, which convenient to select current configuration via input ports.
48	Alternative Config 2 Active	
49	Alternative Config 3 Active	



No	Items	Description
50	Reserved	

8.4 SELECTION OF SENSORS

Table 13 - Sensors Selection

No.	Items	Description	Remark
1	Temperature Sensor	0 Not used 1 Custom resistor type curve 2 Custom current/voltage curve 3 VDO 4 CURTIS 5 VOLVO-EC 6 DATCON 7 SGX 8 SGD 9 SGH 10 PT100 11 SUZUKI 12-15 Reserved	Defined resistance's range is 0~6KΩ, default is SGX sensor.
2	Oil Pressure (Pressure) Sensor	0 Not used 1 Custom resistor type curve 2 Custom current/voltage curve 3 VDO 10Bar 4 CURTIS 5 VDO 5Bar 6 DATCON 10Bar 7 SGX 8 SGD 9 SGH 10 VOLVO-EC 11 SUZUKI 12 4-20mA 10Bar 13 0-5V 10Bar 14-15 Reserved	Factory default is resistor type pressure sensor and defined resistance's range is 0~6KΩ, default is SGX sensor.
3	Liquid (Fuel) Level Sensor	0 Not used 1 Custom resistor type curve 2 Custom current/voltage curve 3 SGD 4 SGH 5 SUZUKI 6-15 Reserved	Defined resistance's range is 0~6KΩ, default is SGH sensor.

△NOTE: pressure sensor and flexible sensor 1 connecting input signals are resistor, current and voltage signals. When configuring "custom current/voltage curve" via controller panel, X coordinate data need to expand tenfold, for example, for 4mA, input data is "40".

8.5 CONDITIONS OF CRANK DISCONNECT SELECTION

Table 14 - Crank Disconnect Conditions Selection

No.	Setting description
0	Gen frequency
1	Speed
2	Speed + Gen frequency
3	Oil pressure
4	Oil pressure + Gen frequency
5	Speed + Oil pressure
6	Speed + Gen frequency + Oil pressure

▲NOTE:

- a) There are 3 conditions to make starter separate with engine; speed, generator frequency and oil pressure can be used separately while oil pressure suggest be used together with speed and generator frequency. The aim is to disconnect the starter motor as soon as possible.
- b) Speed sensor is the magnetic equipment which be installed in starter for detecting flywheel teeth.
- c) When set as speed, must ensure that the number of flywheel teeth is as same as setting, otherwise, “over speed shutdown” or “under speed shutdown” may be caused.
- d) If genset without speed sensor please don’t select corresponding items, otherwise, “start fail” or “loss speed signal” maybe caused.
- e) If genset without oil pressure sensor, please don’t select corresponding items.
- f) If not select generator frequency in crank disconnect setting, controller will not collect and display the relative power quantity (can be used in water pump set); if not select speed in crank disconnect setting, the engine speed displayed in controller is calculated by generator signal.

SmartGen

9 PARAMETERS SETTING

9.1 MENU ITEMS

Start the controller, then press  to enter into the parameters setting menu, menu items are as follows:

- Parameters Set
- Language
- Eventlog
- Controller Information
- Date and Time
- Cycle Start
- Bat Low Volt start

9.2 CONTROLLER PARAMETER SETTINGS

When entered password interface, inputting “0318” can set all parameter items. If the password is changed, only input the password same as controllers’, can the parameter be set via PC software. If there is need to set more parameters or password is forgotten, please contact the factory.

NOTES:

- a) Please change the controller parameters when generator is in standby mode (e. g. Crank disconnect conditions selection, digital inputs, relay outputs, various delays), otherwise, shutdown and other abnormal conditions may occurs.
- b) Over voltage set value must be higher than under voltage set value, otherwise over voltage and under voltage condition may occur simultaneously.
- c) Over speed set value must be higher than under speed set value, otherwise over speed and under speed condition may occur simultaneously.
- d) Please set return values correctly while setting warning alarms, otherwise, alarms fault may occur. Return value need to less than pre-set value while setting high warnings; Return value need to greater than pre-set value while setting low warnings;
- e) Please set the generator frequency value as low as possible when cranking, in order to make the starter be separated quickly as soon as possible.
- f) Auxiliary input 1~7 cannot set as same items; otherwise, there are abnormal functions. However, the auxiliary output 1~6 can be set as same items.

9.3 LANGUAGE SELECTION

Chinese, English, and other languages can be optional, other languages default as Spanish.

9.4 EVENT LOG

Max 99 pieces of historical records can be checked via this item.

9.5 CONTROLLER INFORMATION

- a) LCD will display development information of controller like software version, issue date of the controller.
- b) In this screen, press  will display the digital inputs and outputs status.

c) In this screen, press  will display boot screen.

9.6 TIME SETTING

In this page, time & data information of controller can be calibrated.

9.7 CYCLE START SETTING

In this page, enable cycle start gen-sets can be set. Users can configure the main/standby set and genset running time.

9.8 BATTERY UNDER VOLTAGE START SETTING

In this page, enable battery under voltage start can be set. Users can configure the start/stop and delay values.

10 GENSETS CYCLE START

Cycle start means controlling two generator-sets circulatory start/stop. Two sets intercommunication via RS485 port. Main set send commands to control the backup set to start/stop and check fault status of backup set. The priority unit can be configured through parameter settings or input port settings (only active in auto mode).

Operational Process:

- a) When remote start input is active, the main set, which in standby status, will start automatically, and the running time is pre-configured "Main Set Running Time";
- b) If "Main Set Running Time" is expired or alarm shutdown, main set will send command to start backup set. When backup set remote start input is active, it will start up and main set will stop as soon as the standby unit is normal running. Backup running time is pre-configured "Backup Set Running Time";
- c) In the whole process, main set communicates with backup set via RS485, if backup unit running time is expired or alarm shutdown, main set will cyclic start up again.
- d) If communication error, controller will initiate "Cycle Start Comm. Fail" alarm, then main/backup set will start if remote start input of main/backup set is active.

11 SENSOR SETTING

- When reselect sensors, the sensor curve will be transferred into the standard value. For example, if temperature sensor is SGH (120°C resistor type), its sensor curve is SGH (120°C resistor type); if select the SGD (120°C resistor type), the temperature sensor curve is SGD curve.
- When there is difference between standard sensor curves and using sensor, user can adjust it in “curve type”.
- When input the sensor curve, X value (resistor) must be input from small to large, otherwise, mistake occurs.
- If sensor is select as “Not Used”, sensor curve will not work.
- The corresponding sensor must configured as “Not Used” if sensor only has alarm switch, otherwise, alarm shutdown or warning may occur.
- The headmost or backmost values in the vertical coordinates can be set as same as below,

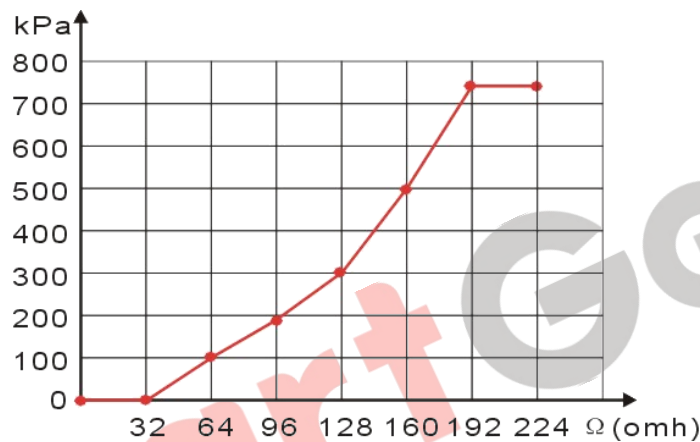

Figure 4 – Curve Setting

Table 15 - Common unit conversion table

Items	N/m ² (pa)	kgf/cm ²	bar	(p/in ² .psi)
1Pa	1	1.02x10 ⁻⁵	1x10 ⁻⁵	1.45x10 ⁻⁴
1kgf/cm ²	9.8x10 ⁴	1	0.98	14.2
1bar	1x10 ⁵	1.02	1	14.5
1psi	6.89x10 ³	7.03x10 ⁻²	6.89x10 ⁻²	1

12 COMMISSIONING

Please make sure the following checks are made before commissioning,

- Ensure all the connections are correct and wires diameter is suitable.
- Ensure that the controller DC power has fuse, controller's positive and negative connected to start battery are correct.
- Emergency stop input is connected to the positive pole of starter battery via emergency stop button's normally closed point and fuse.
- Take proper action to prevent engine to crank success (e. g. Remove the connection wire of fuel valve). If checking is OK, make the start battery power on; choose manual mode and controller will executive routine.
- Set controller under manual mode, press "start" button, genset will start. After the cranking times as setting, controller will send signal of Start Failure; then press "stop" to reset controller.
- Recover the action to prevent engine to crank success (e. g. Connect wire of fuel valve), press start button again, genset will start. If everything goes well, genset will normal running after idle running (if idle run be set). During this time, please watch for engine's running situations and AC generator's voltage and frequency. If abnormal, stop genset and check all wires connection according to this manual.
- Select the **AUTO** mode from controller's panel, connect mains signal. After the mains normal delay, controller will transfer ATS (if fitted) into mains load. After cooling time, controller will stop genset and make it into "at rest" mode until there is mains abnormal situation.
- When mains is abnormal again, genset will be started automatically and enter into normal running, then controller send signal to making generator switch on, and control the ATS transfer into generator load. If not like this, please check ATS' wires connection according to this manual.
- If there is any other question, please contact SmartGen's service.

SmartGen

13 TYPICAL APPLICATION

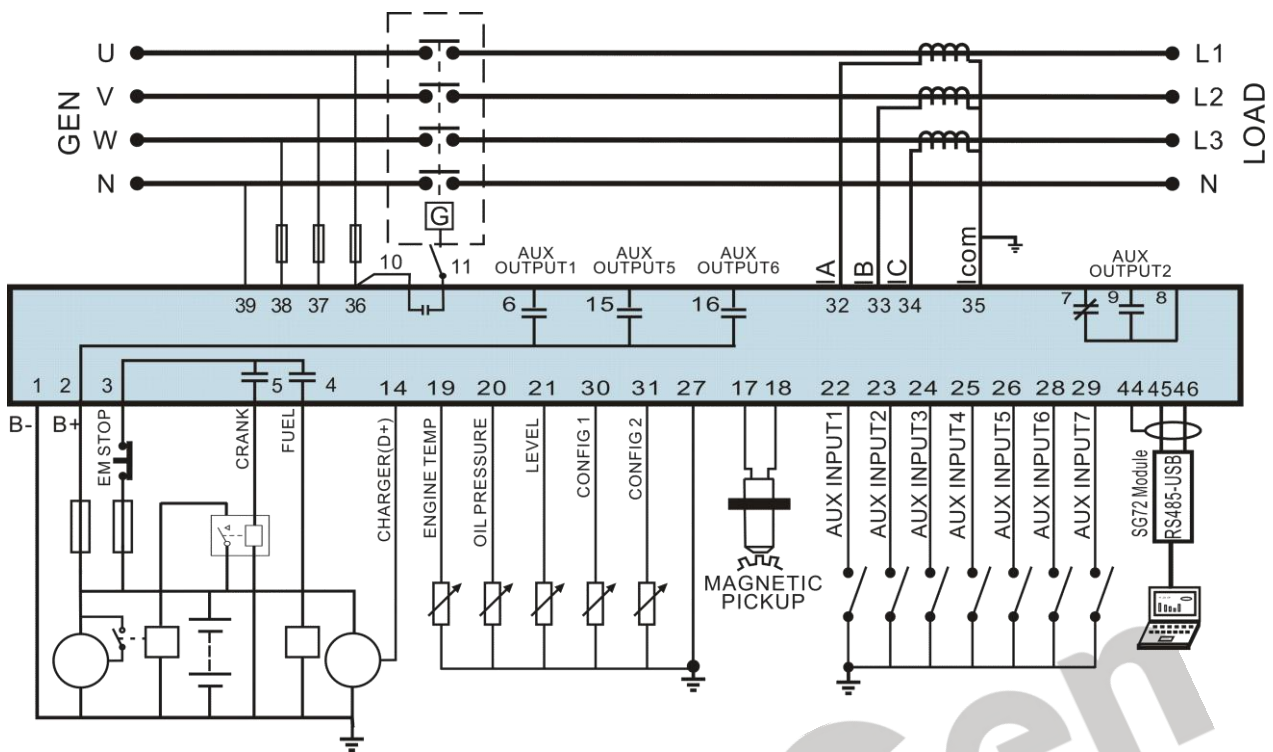

Figure 5 - HGM7100N Typical Application

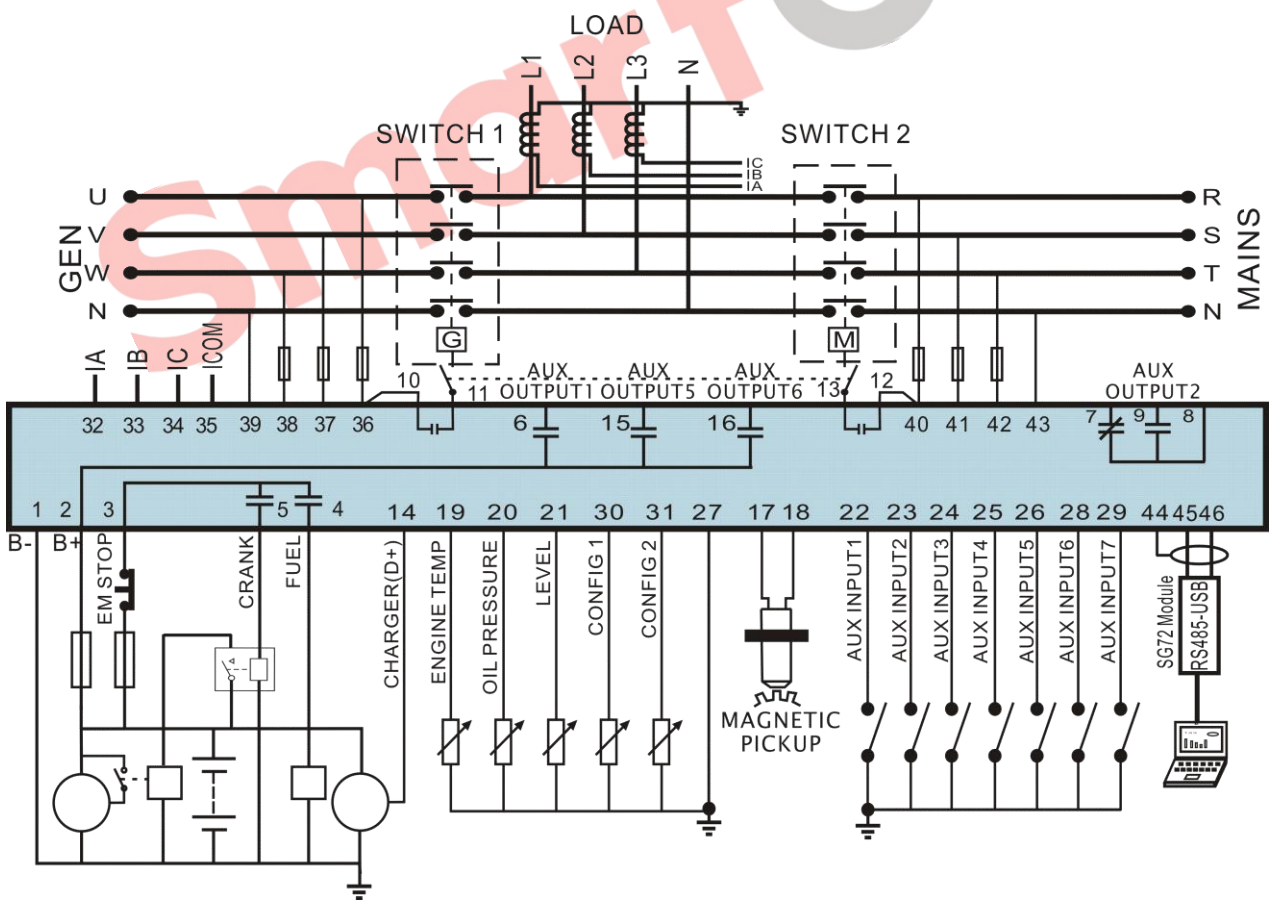

Figure 6 - HGM7120N Typical Application

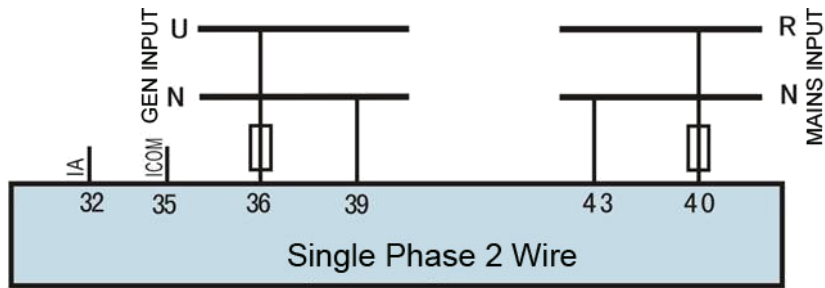

Figure 7 - Single Phase 2-Wire Connection Diagram

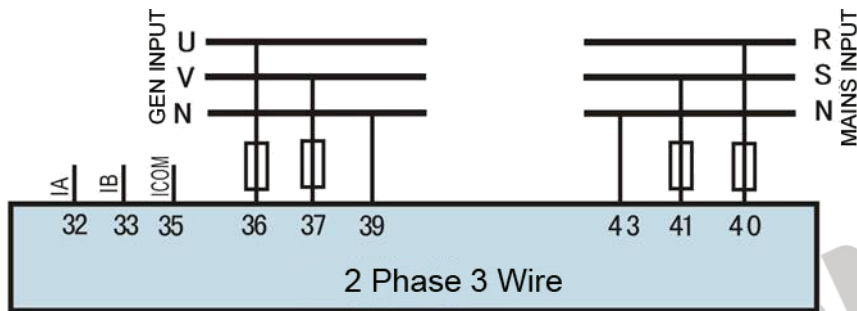
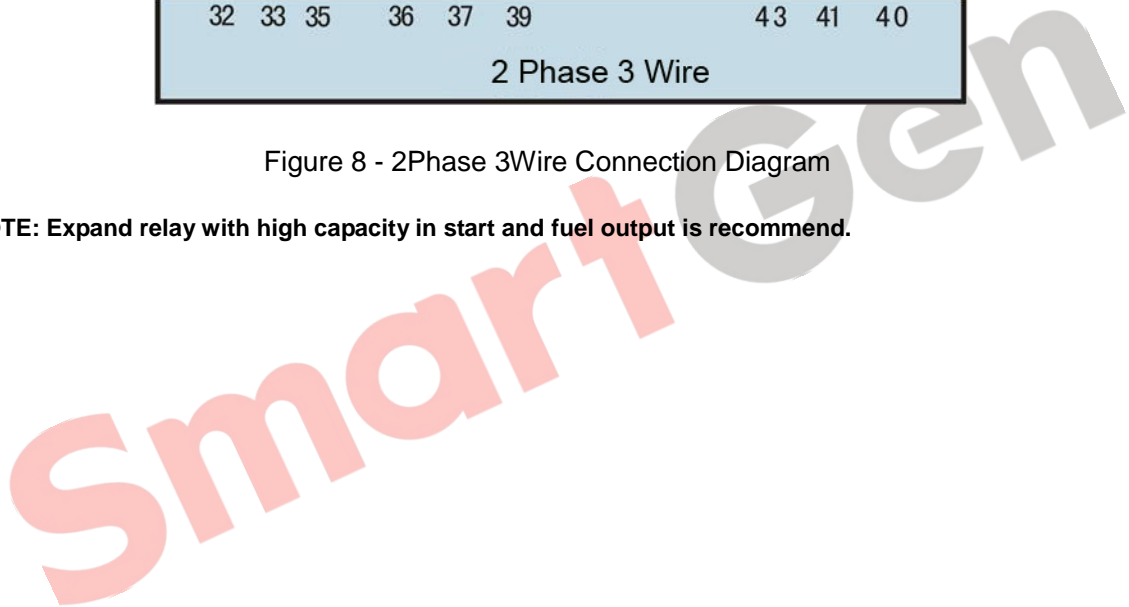

Figure 8 - 2Phase 3Wire Connection Diagram

▲ NOTE: Expand relay with high capacity in start and fuel output is recommend.



14 INSTALLATION

14.1 FIXING CLIPS

- Controller is panel built-in design; it is fixed by clips when installed.
- Withdraw the fixing clip screw (turn anticlockwise) until it reaches proper position.
- Pull the fixing clip backwards (towards the back of the module) ensuring two clips are inside their allotted slots.
- Turn the fixing clip screws clockwise until they are fixed on the panel.

▲ Note: Care should be taken not to over tighten the screws of fixing clips.

14.2 OVERALL DIMENSION

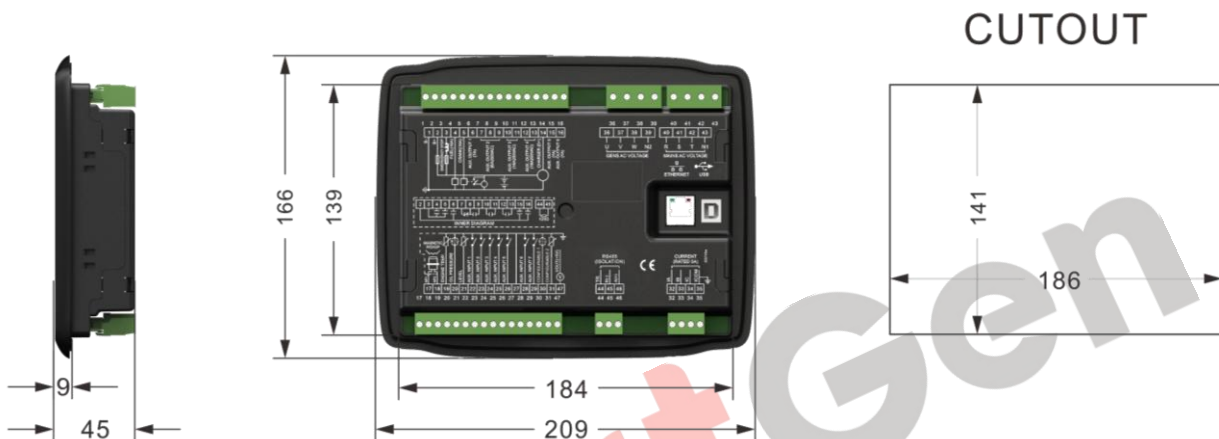

Figure 9 - Overall Dimensions

HGM7100N series controller can suit for widely range of battery voltage DC (8~35) V. Negative of battery must be connected with the engine shell. Diameter of wire that connects from power supply to battery must be over 2.5mm^2 . If floating charge configured, please firstly connect output wires of charger to battery's positive and negative directly, then, connect wires from battery's positive and negative to controller's positive and negative input ports in order to prevent charge disturbing the controller's normal working.

a) SPEED SENSOR INPUT

Speed sensor is the magnetic equipment which be installed in starter and for detecting flywheel teeth. Its connection wires to controller should apply for 2 cores shielding line. The shielding layer should connect to No. 18 terminal in controller while another side is hanging in air. The else two signal wires are connected to No.17 and No.18 terminals in controller. The output voltage of speed sensor should be within (1~24) VAC (effective value) during the full speed. 12VAC is recommended (in rated speed). When install the speed sensor, let the sensor is spun to contacting flywheel first, then, port out 1/3 lap, and lock the nuts of sensor at last.

b) OUTPUT AND EXPAND RELAYS

All outputs of controller are relay contact output type. If need to expand the relays, please add freewheel diode to both ends of expand relay's coils (when coils of relay has DC current) or, increase resistance-capacitance return circuit (when coils of relay has AC current), in order to prevent disturbance to controller or others equipment.

c) AC INPUT

Current input of HGM7100N series controller must be connected to outside current transformer. And

the current transformer's secondary side current must be 5A. At the same time, the phases of current transformer and input voltage must correct. Otherwise, the current of collecting and active power maybe not correct.

d) WITHSTAND VOLTAGE TEST

When controller had been installed in control panel, if need the high voltage test, please disconnect controller's all terminal connections, in order to prevent high voltage into controller and damage it.

▲NOTE:

- a) **ICOM port must be connected to negative pole of battery.**
- b) **When there is load current, transformer's secondary side prohibit open circuit.**

SmartGen

15 TROUBLESHOOTING

Table 16 - Fault and Solutions

Symptoms	Possible Solutions
Controller no response with power.	Check starting batteries; Check controller connection wirings; Check DC fuse.
Gen-set shutdown	Check the water/cylinder temperature is too high or not; Check the gen-set AC voltage; Check DC fuse.
Controller emergency stop	Check the function of emergency stop is correct or not; Check whether the positive electrode of battery is connected with emergency stop input correctly or not; Check whether wire connection open circuit or not.
Low oil pressure alarm after crank disconnect	Check the oil pressure sensor and its connections.
High water temp. alarm after crank disconnect	Check the temperature sensor and its connections.
Shutdown Alarm in running	Check related switch and its connections according to the information on LCD; Check programmable inputs.
Crank not disconnect	Check fuel oil circuit and its connections; Check starting batteries; Check speed sensor and its connections; Refer to engine manual.
Starter no response	Check starter connections; Check starting batteries.
Gen-set running while ATS not transfer	Check ATS; Check the connections between ATS and controllers.
RS485 communication is abnormal	Check connections; Check setting of COM port is correct or not; Check RS485's connections of A and B is reverse connect or not; Check communication port of PC whether damage. Add 120Ω resistor between A and B of RS485 is recommended.