



SmartGen
ideas for power

HGM1790N
GENSET CONTROLLER
USER MANUAL



SMARTGEN (ZHENGZHOU) TECHNOLOGY CO., LTD.



Chinese trademark

SmartGen English trademark

SmartGen — make your generator *smart*

SmartGen Technology Co., Ltd

No. 28 Jinsuo Road

Zhengzhou

Henan Province

P. R. China

Tel: 0086-371-67988888/67981888

0086-371-67991553/67992951

0086-371-67981000(overseas)

Fax: 0086-371-67992952

Web: www.smartgen.com.cn

www.smartgen.cn

Email: sales@smartgen.cn

All rights reserved. No part of this publication may be reproduced in any material form (including photocopying or storing in any medium by electronic means or other) without the written permission of the copyright holder.

Applications for the copyright holder's written permission to reproduce any part of this publication should be addressed to SmartGen Technology at the address above.

Any reference to trademarked product names used within this publication is owned by their respective companies.

SmartGen Technology reserves the right to change the contents of this document without prior notice.

Software Version

Date	Version	Note
2016-10-11	1.0	Original release.
2017-10-09	1.1	1) Changed "Stop Output Relay" and "Idle Control Relay" into "Aux. Output"; Changed rare panel description and typical application description; Added "Aux. Output 1" and "Aux. Output 2" configuration options. 2) Modified storage temperature.

CONTENT

1. OVERVIEW	4
2. PERFORMANCE AND CHARACTERISTICS	4
3. SPECIFICATION	6
4. OPERATION	7
4.1. FRONT PANEL DESCRIPTION	7
4.2. INDICATOR LIGHTS	7
4.3. PANEL KEYS	8
4.4. LCD ICONS	8
4.5. DISPLAY DESCRIPTION	9
4.6. AUTO START/STOP OPERATION	10
4.7. MANUAL START/STOP OPERATION	11
5. PROTECTION	11
6. CONTROLLER BACK PANEL	13
7. PARAMETER RANGE AND DEFINITION	15
7.1 PARAMETERS CONFIGURATION (TABLE 1)	15
7.2 DEFINITION OF RELAY OUTPUTS (TABLE 2)	19
7.3 DEFINITION OF DIGITAL INPUTS (ACTIVE WHEN CONNECT TO GND (B-)) (TABLE 3)	19
7.4 SENSOR SELECTION (TABLE 4)	20
7.5 CONDITIONS OF CRANK DISCONNECT (TABLE 5)	21
8. CONTROLLER FUNCTION SETTING	21
8.1. PARAMETER SETTING	21
8.2. LCD CONTRAST ADJUSTMENT	22
8.3. GENERATOR FLYWHEEL TEETH AUTOMATIC ADJUSTMENT	22
9. SENSOR SETTINGS CLARIFICATION	23
10. COMMISSIONING	24
11. TYPICAL APPLICATION	24
12. INSTALLATION	25
12.1. FIXING CLIPS	25
12.2. OVERALL DIMENSION	25
13. FAULT FINDING	27



1. OVERVIEW

HGM1790N genset controller is suit for single unit automation and monitoring control (also can be used for pumping unit). It can be started and stopped manually or via a remote start/stop signals. HGM1790N controller can supervise and protect genset operation by gathering and analyzing genset data like generate voltage, current, water temperature, oil pressure and so on, and graphical LCD monitor on the front panel displays fault conditions and provides effective alarm signals so as to do maintenance as soon as possible. Moreover, parameter threshold and delay value can be adjusted via front panel or USB port (communicated with PC software).

2. PERFORMANCE AND CHARACTERISTICS

- Graphical LCD display(with backlight), LED indicator, touch-buttons operation;
- Hard screen acrylic material is used to protect screen.
- Silicone panel and buttons are adopted to increase high and low temperature adaption ability.
- Power supply range DC (8~35)V, compatibility with 12V or 24V starter batteries;
- Generator single phase voltage, current, frequency, power and load percentage parameters are measured and displayed:

Generator Voltage	V	Generator Frequency	Hz
Generator Power	kW	Generator Current	A
Load Percentage	%		

- Precision measured and displayed electric quantity of generator:

Oil Pressure	kPa	Temperature	°C
Fuel Level	%	Total Running Time	H (max. 199999 hours)
Battery Voltage	V	Engine Speed	RPM
Accumulated Start Times (max. 199999 times, displayed on PC)			

- With genset fault protection and display functions.
- 3 working modes: manual, auto, stop;
- Compatibility with multiple temperature, pressure, fuel level sensors, which can be user-defined and used directly; temperature sensors, pressure sensors can be used in parallel with annunciator, providing analog quantity and increasing protection level at the same time;
- Multiple crank disconnect conditions to select (engine speed sensor, oil pressure, generator frequency);
- 1 configurable input port which can be set as digital input or liquid level sensor;



- 2 fixed relay outputs (fuel relay, start relay);
- 3 configurable output ports which can be set as common alarm output, preheat output or idle control output;
- Parameters can be set and modified by users and saved in internal FLASH storage, which means that they will not be lost in case of power off. Most parameters of the controller can be modified using the front panel and all parameters can be adjusted by PC software via type-B USB port;
- Digital regulation of all parameters - instead of analog regulation using conventional potentiometer - and, therefore, higher reliability and stability;
- Modular design, self extinguishing ABS plastic enclosure and embedded installation way; small size and compact structure with easy mounting

SmartGen



3. SPECIFICATION

Item	Content
Working Voltage	DC8. 0V to 35. 0V, Continuous Power Supply
Power Consumption	<1.2W (Standby mode: ≤0.5W)
Alternator voltage Input	AC 15V ~ AC 360 V (ph-N)
Alternator Frequency	50/60Hz
Speed Sensor Voltage	1.0V to 24V (RMS)
Speed Sensor Frequency	Max. 10KHz
Start Relay Output	1Amp DC28V DC B+ power supply
Fuel Relay Output	1Amp DC28V DC B+ power supply
Aux. Output1	1Amp DC28V DC B+ power supply
Aux. Output2	1Amp DC28V DC B+ power supply
Aux. Output3	1Amp DC28V DC B+ power supply
Programmable Digital Input	Active when connected to B-
Case Dimensions	95mm x 86mm x 46.5mm
Panel Cutout	78mm x 66mm
CT Secondary Current	Rated: 5A
Working conditions	Temperature: (-25~+70)°C Humidity: (20~93)%RH
Storage Condition	Temperature: (-25~+70)°C
Protection Level	IP55: When waterproof rubber gasket installed between the controller and panel fascia.
Insulation Intensity	Attach AC2.2kV voltage between AC high voltage terminal and low voltage terminal (leak current below 3mA in 1 minute).
Weight	0.18kg



4. OPERATION

4.1. FRONT PANEL DESCRIPTION



4.2. INDICATOR LIGHTS

Stop status indicator light: genset in stop mode.





Auto status indicator light: genset in auto mode.

Manual start indicator light: genset in manual mode.















Alarm indicator light: blink slowly (1time/s) when warn alarm occurred; blink fast (5 times/s) when shutdown alarm occurred.



4.3. PANEL KEYS

Key	Definition	Description
	Stop/Reset	In auto/manual mode, press this button will shutdown the genset; Reset shutdown alarms when genset in alarm status; Indicator lights and LCD icons status can be tested if press this button for over 3s in stop mode; Stop immediately if press this button during stop process; Quick exist parameter setting menu if press this button.
	Auto/Increase	Pressing this button will place the module into its auto mode, and genset is controlled by remote start signals; In settings menu moves cursor up and increases the set value.
	Start/Decrease	Pressing this button will start genset. In settings menu moves cursor down and decreases the set value.
	Page Down	Using this button you can scroll pages of the LCD monitor; Enter settings menu if hold and press over 2s; Move cursor and confirm setting information in parameter setting menu.

4.4. LCD ICONS

Icon	Definition	Icon	Definition
	Genset start indication	FL	Fuel Level Indication
	Boot time is counting(reaching crank disconnect condition)	L1	Generator Voltage Indication
	Emergency Stop Alarm	DC	Battery Voltage Indication
	Over Speed/Over Frequency Alarm	kPa	Oil Pressure Unit
	Under Speed/Under Frequency Alarm	A	Current With Load Unit
	High Temp. Alarm	H	Hours Count
	Low Fuel Level	Hz	Frequency Unit
	Auxiliary Alarm	°C	Temperature Unit
	Low Oil Pressure	rpm	Speed Unite (revolutions per minute)
	Fail to start	kW	Active Power Unit
	Fail to stop	V	Voltage Unit
	Voltage Abnormal	%	Percentage
	Over Voltage		
	Under Voltage		
	Over Current With Load		



4.5. DISPLAY DESCRIPTION

Generator: phase voltage L1, frequency F



Load: active power, current



Load percentage



Oil pressure, temperature



Fuel level, total running time



Battery voltage, generator speed



Parameter setting



Remark:

- 1) When active power is “---”, which means active power is negative, please check voltage and current connection.
- 2) Pressure, temperature and liquid level sensors are not displayed, which means not used; when displayed “OFF” means sensors are open circuit.
- 3) When total running time are lower than 20000 hours, value before the decimal point is means running hours and value after the decimal point is means 1/10 hour.



4.6. AUTO START/STOP OPERATION

Auto mode is selected by pressing ; a LED besides the button will illuminate to confirm the operation.

Automatic Start Sequence:

- 1) When “Remote Start” is active(6 terminal connect with B-), “Start Delay” timer is initiated;
- 2) When start delay is over, preheat relay energizes (if configured), preheat delay starts to count.
- 3) After the preheat delay, the Fuel Relay (if configured) is energized, and then one second later, the Start Relay is engaged. If the engine fails to fire during this cranking attempts then the fuel relay and start relay are stop to output; “crank rest time” begins and wait for the next crank attempt.
- 4) Should this start sequence continue beyond the set number of attempts, the start sequence will be terminated,  will be displayed on LCD means Fail to Start and meanwhile, alarm indicator light is blinking.
- 5) In case of successful crank attempt, the “Safety On” timer is activated, allowing Low Oil Pressure, High Temperature and etc. alarms are without triggering the fault. As soon as this delay is over, “start idle” delay is initiated (if configured).
- 6) During “start idle” delay, under speed, under frequency, under voltage alarms are inhibited. When this delay is over, “warming up” delay is initiated (if configured).
- 7) When “warming up delay” is over, genset start normal running; if generator voltage or frequency is abnormal, shutdown alarm signals will be sent by the controller.

Automatic Stop Sequence,



- 1) When the “Remote Start” signal is removed, the Stop Delay is initiated.
- 2) Once this “stop delay” has expired, the Generator Breaker will open and the “Cooling Delay” is then initiated.
- 3) During “Stop Idle” Delay (if configured), idle relay is energized.
- 4) “ETS Solenoid Hold” begins, ETS relay is energized while fuel relay is de-energized.
- 5) “Fail to Stop Delay” begins, complete stop is detected automatically.
- 6) Generator is placed into its standby mode after its “After stop” delay. Otherwise, fail to stop alarm is initiated.(LCD display )

Remark:

- a) When press stop button in auto start status, genset will be stopped and enter into stop mode simultaneously.
- b) When in process of crank rest delay, preheat and ETS functions are energized when fuel output is de-energized and crank rest time countdown is less than 7s. After crank rest delay, ETS output is de-energized, fuel relay starts output, and preheat relay output is off before crank.







4.7. MANUAL START/STOP OPERATION

- 1) **MANUAL START:** Press  button to start the gen-set (No.2~7 of Automatic Start Sequence for detail procedures). With high temperature, low oil pressure, over speed and abnormal voltage during generator running, controller can protect genset to stop quickly.
- 2) **MANUAL STOP:** Press  can shuts down the running generators. (Please refer to No.2~6 of **Automatic Start Sequence** for detail procedures).

5. PROTECTION

Controller Alarms are as follows,

Icons	Alarms	Type	Triggering Condition
	Emergency Shut Alarm	Shut Alarm	Controller sent alarms when detected emergency shutdown alarms.
	Over Speed Shut	Shut Alarm	Controller sent alarms when genset speed is higher than over speed threshold and last for over 2s.
	Over Frequency Shut	Shut Alarm	Controller sent alarms when generator frequency is higher than over frequency threshold and last for over 2s.
	Under Speed Shut	Shut Alarm	Detection after the idle delay, controller sent alarms when genset speed is lower than under speed threshold and last for over 10s.
	Under Frequency Shut	Shut Alarm	Detection when genset is normal running, controller sent alarms once genset frequency fell below under frequency threshold and last for over 10s.
	High Temp. Shut	Shut Alarm	Detection after safe running delay, controller sent alarms once genset temperature is higher than over temp. threshold and last for over 3s.
	High Temp. Input Shut	Shut Alarm	Detection after safe running delay, controller sent alarms when high temperature input is active.
	Temp. Sensor Open/Short Circuit Shut	Shut Alarm	Detection after safe running delay, controller sent alarms when temperature sensor resistance value is above 6000Ω or under 5Ω.
	Low Oil Pressure Shut	Shut Alarm	Detection after safe running delay, controller sent alarms when genset oil temperature is lower than low oil pressure threshold and last for over 2s.
	Low Oil Pressure Input Shut	Shut Alarm	Detection after safe running delay, controller sent alarms when low oil pressure input is active.
	Oil Pressure Sensor Open/Short Circuit Shut	Shut Alarm	Detection after safe running delay, controller sent alarms when oil pressure sensor resistance value is above 6000Ω or under 5Ω.



Icons	Alarms	Type	Triggering Condition
	Gen Over Current Warn	Warn Alarm	Controller sent alarms when generator current is higher than the preset value and over current action is selected as “Warn”.
	Gen Over Current Shut	Shut Alarm	Controller sent alarms when generator current is higher than the preset value and last for over than the delay value (over current action is selected as “Shutdown”).
	Gen Over Current Cooling Shut	Shut Alarm	Controller sent alarms when generator current is higher than the preset value and last for over than the delay value (over current action is selected as “Cooling Shutdown”).
	Gen Over Volt Shut	Shut Alarm	Detection after safe running delay, controller sent alarms when generator voltage is higher than over voltage threshold and last for over than voltage abnormal delay value.
	Gen Low Volt Shut	Shut Alarm	Detection after safe running delay, controller sent alarms when generator voltage is lower than under voltage threshold and last for over than voltage abnormal delay value.
	Fail to Start	Shut Alarm	Controller Sent alarms when genset fail to start in preset attempts.
	Auxiliary Shut Warn Input	Shut Alarm	Controller sent alarms when auxiliary input port, which is configured as “auxiliary shutdown alarm input”, is active.
	Low Fuel Level Warn	Warn Alarm	Controller sent alarms when fuel level is lower than low fuel level threshold and last for over 10s.
	Low Fuel Level Input Warn	Warn Alarm	Controller sent alarms when low fuel level input is active.
	Fuel Level Sensor Open/Short Circuit Shut	Warn Alarm	Controller sent alarms when Fuel level sensor resistance value is above 6000ohm or under 5 ohm.
	Fail to Stop	Warn Alarm	Controller sent alarms when genset fail to stop in stop duration.
	Low Battery Volt Warn	Warn Alarm	Controller sent alarms when battery voltage is lower than under voltage threshold and last for over 20s.
	High Battery Volt Warn	Warn Alarm	Controller sent alarms when battery voltage is higher than over voltage threshold and last for over 20s.



6. CONTROLLER BACK PANEL



Terminals description as follows,

No.	Function	Cable Size	Remarks
1	DC Voltage Input B-	1.5mm ²	Connect to negative of starter battery
2	DC Voltage Input B+	1.5mm ²	Connected to positive of starter battery. If wire length is over 30m, better to double wires in parallel. Max. 20A fuse is recommended.
3	Emergency Stop Input	1.0mm ²	B+ voltage input is active, and connected to emergency stop normal closed button.
4	Fuel Output	1.0mm ²	B+ is supplied by No.3 point, rated 1A.
5	Crank Output	1.0mm ²	B+ is supplied by No.3 point, rated 1A.
6	Remote Start Input	1.0mm ²	Ground connected is active (B-)
7	Aux. Input	1.0mm ²	Ground connected is active (B-) if it is configured as switch input value. Connect to low fuel level switch value or fuel level resistor type sensor.
8	Oil Pressure Input	1.0mm ²	Connect to low oil pressure switch value or resistor type sensor.
9	Engine Temp. Input	1.0mm ²	Connect to high water/cylinder temp. switch value or temperature resistor type sensor.
10	Magnetic Pickup	0.5mm ²	Connect to speed sensor, and shielded wire is recommended. The other end of speed sensor is connected to B-.
11	Gen Volt Monitoring	1.0mm ²	Connect to generator voltage output port.
12	Input	1.0mm ²	(2A fuse is recommended)



No.	Function	Cable Size	Remarks
13	Load Current(Inlet Loop)	1.5 mm ²	Connect to secondary coil of current transformer.(Rated 5A)
14	Load Current(Outlet Loop)	1.5 mm ²	
15	Aux. Output 1	1.0 mm ²	B+ is supplied by No.2 point, rated 1A.
16	Aux. Output 2	1.0 mm ²	B+ is supplied by No.2 point, rated 1A.
17	Aux. Output 3	1.0 mm ²	B+ is supplied by No.2 point, rated 1A.

Remark: Type-B USB port, which can be connected with PC software, is apply for parameter configuration and data monitoring.

SmartGen



7. PARAMETER RANGE AND DEFINITION

7.1 PARAMETERS CONFIGURATION (TABLE 1)

No.	Parameter	Range	Default Value	Description
P00	Start Delay	(0-3600)s	1	Time from remote start signal is active to start genset.
P01	Stop Delay	(0-3600)s	1	Time from remote start signal is deactivated to genset stop.
P02	Start Attempts	(1-10) times	3	The maximum number of crank attempts. If none of them is successful, the controller will initiate fail to start alarm.
P03	Preheat Time	(0-300)s	0	Time of pre-powering heat plug before starter is powered up.
P04	Cranking Time	(3-60)s	8	The time of powering up the starter for every crank attempt
P05	Crank Rest Time	(3-60)s	10	The waiting time before second power up when engine start fail.
P06	Safety On Delay	(1-60)s	10	Alarms for low oil pressure, high temperature, under speed, under frequency and under voltage are inactive.
P07	Start Idle Time	(0-3600)s	0	Idle running time of genset when starting.
P08	Warming Up Time	(0-3600)s	10	Warming time between genset switch on and normal running.
P09	Cooling Time	(3-3600)s	10	Radiating time before genset stop, after it unloads.
P10	Stop Idle Time	(0-3600)s	0	Idle running time when genset stop.
P11	ETS Solenoid Hold	(0-120)s	20	The time of powering up the electromagnet during stop procedure.
P12	Fail to Stop Delay	(0-120)s	0	Time between ending of genset idle delay and stopped when "ETS time" is set as 0; Time between ending of ETS hold delay and stopped when "ETS Hold output time" is not 0.
P13	Flywheel Teeth	(1-300)	118	Tooth number of the engine is for judging of crank disconnect conditions and inspecting of engine speed. See the installation instructions.
P14	Generator Poles	(2-16)	4	Configuring numbers of generator poles.
P15	Generator Abnormal Time	(0-20.0)s	10.0	Alarm delay for generator over and under voltage states.



No.	Parameter	Range	Default Value	Description
P16	Generator Over Voltage	(30-1000)V	264	When generator voltage exceeds this value and stays so for the time of 'Generator Abnormal Time', it is regarded as over voltage and Generator Over Voltage shutdown alarm is initiated. If the voltage value is 1000V, over voltage signal is not initiated.
P17	Generator Under Voltage	(30-1000)V	196	When detected voltage falls below this value and stays so for the time of 'generator abnormal state delay', it is regarded as under voltage and Generator Under Voltage shutdown alarm is initiated. If the voltage value is 30V, under voltage signal is not initiated.
P18	Engine Under Speed	(0-6000)RPM	1200	When engine speed falls below this value and stays so for 10 seconds, this is regarded as under speed and under speed alarm shutdown signal is sent.
P19	Engine Over Speed	(0-6000)RPM	1710	When engine speed exceeds this value and stays so for 2 seconds, this is regarded as over speed and over speed alarm shutdown signal is sent.
P20	Under Frequency	(0-75.0)Hz	45.0	When generator frequency falls below this value and stays so for 10 seconds, it is regarded as under frequency and under frequency alarm shutdown is initiated.
P21	Over Frequency	(0-75.0)Hz	57.0	When generator frequency exceeds this value and stays so for 2 seconds, it is regarded as an over frequency and over frequency alarm shutdown is initiated.
P22	High Temperature	(80-140)°C	98	When the temperature value of the external temperature sensor exceeds this threshold, high temperature signal is sent. Detection starts after safety delay and only concerns external temperature sensor which connected to the temperature sensor input port. If the set value is 140, high temperature signal will



No.	Parameter	Range	Default Value	Description
				not be sent (this only concerns temperature sensor, not high temperature signal via config. input port).
P23	Low Pressure Oil	(0-400)kPa	103	When the external pressure sensor value falls below this threshold, low oil pressure delay begins. Detection begins after safely on delay. If the set value is 0, low oil pressure signal is not sent (this only concerns pressure sensor and does not concern low oil pressure warning signal via configurable input port)
P24	Low Level Liquid	(0-100)%	10	When the liquid level of the external sensor falls below this value and stays so for 10 seconds, low liquid level signal is sent and warning without shutdown is initiated.
P25	Battery Over Volts	(12-40)V	33.0	When battery voltage exceeds this value and stays so for 20 seconds, Battery Over Volts signal is sent and warning without shutdown is initiated.
P26	Battery Under Volts	(4-30)V	8.0	When battery voltage falls below this value and stays so for 20 seconds, Battery Under Volts signal is sent and warning without shutdown is initiated.
P27	CT Ratio	(5-6000)/5	500	Current transformer ratio default as 500:5.
P28	Full-load Current	(5-1900)A	500	It is the rated current of generator, which is apply for calculating over current with load.
P29	Over Current Percentage	(50-130)	120	Over current delay starts when current with load is greater than value of full-load current multiply over current percentage.
P30	Over Current Delay	(0-3600)s	60	When current with load exceeds preset value and stays so over delay time, over current alarm will be initiated.
P31	Action	(0-2)	0	0: Warn 1: Shutdown 2: Cooling and Shutdown
P32	Aux. Output 3	(0-9)	1	Default: Common Alarm
P33	Digital Input	(0-8)	4	Default: Auxiliary shutdown; if the set



No.	Parameter	Range	Default Value	Description
				value is 8, fuel level sensor type can be selected.
P34	Digital Input Delay	(0-20.0)s	2.0	Active delay time for digital input ports
P35	Power On Mode	(0-2)	0	0: Shutdown 1: Auto 2:Manual
P36	Password Set	(0-9999)	0318	
P37	Crank Disconnect Condition	(0-6) See table 5.	1	Starter motor disconnection condition. There are 3 conditions of disconnecting starter with engine (magnetic pickup, generator frequency and oil pressure). Aiming at to separate the start motor and genset as soon as possible.
P38	Disconnect Engine Speed	(0-3000) RPM	360	When generator speed is higher than the set value, starter will be disconnected.
P39	Disconnect Generator Freq	(10.0-30.0) Hz	14.0	When generator frequency higher than the set value, starter will be disconnected.
P40	Disconnect Oil Pressure	(0-400) kPa	200	When generator oil pressure higher than the set value, starter will be disconnected and oil engine crank successfully.
P41	AC System	(0-3)	2	0: 3P4W 1: 2P3W 2: 1P2W 3: 3P3W It is used for calculating generator voltage and active power.
P42	Temperature Sensor	(0-10)	06	SGD (120°C resistor type)
P43	Oil Pressure Sensor	(0-10)	06	SGD (10Bar resistor type)
P44	Fuel Level Sensor	(0-7)	0	Not used. (If fuel level sensor is used, then the digital input port must be set as 'not used').
P45	Disconnect Oil Pressure Delay	(0-20.0)s	0.0s	When crank disconnect condition including oil pressure, and engine oil pressure and delay value are higher than set values, starter will be disconnected and oil engine crank successfully.
P46	Aux. Output 1	(0-9)	3	Default: Idle Speed Output
P47	Aux. Output 2	(0-9)	2	Default: ETS Output



7.2 DEFINITION OF RELAY OUTPUTS (TABLE 2)

No.	Items	Description
0	Not Used	Output is not active.
1	Common Alarm	Includes all shutdown alarms and warning alarms. Warning alarms are not self-latching, while shutdown alarms are and will not disappear until they are reset.
2	Energized to Stop	Suitable for the genset with stop electromagnet. The electromagnet closes when stop idle is over. And opens when EST delay is over.
3	Idle Control	Used for machines that have idle mode. Closes during cranking, disconnects during warming up, closes during stop idle delay, disconnects after complete stop.
4	Preheat Control	It closes before starting and opens before starter is power on.
5	Closing Gens	During normal operation of the generator, closes the breaker.
6	High Speed Output	Output when enter high speed warning up and off after high speed cooling.
7	Reserved	
8	Reserved	
9	Reserved	

7.3 DEFINITION OF DIGITAL INPUTS (ACTIVE WHEN CONNECT TO GND (B-)) (TABLE 3)

No.	Description	Notes
0	Not Used	
1	High Temperature Input	If these signals are activated after crank disconnect, shutdown alarm will be immediately initiated.
2	Low OP Warning Input	
3	Reserved	Only warning and not stops if this input is active.
4	Auxiliary Shutdown	Shutdown alarm will be immediately initiated if this input is active.
5	High Temperature cooling & Stop Input	When the gen-set is working normally and this signal is activated, if there is a high temperature situation, the controller will first cool down the generator and then stop it; if the signal is deactivated and a high temperature situation occurs, the controller will shut down the gen-set without cooling down.
6	Reserved	
7	Reserved	
8	Multiplex Level Sensor	Parameter P44 "Fuel Level Sensor" Input is active.



7.4 SENSOR SELECTION (TABLE 4)

No.	Items	Content	Remark
1	Temperature Sensor	0 Not used 1 Low digital input is active 2 High digital input is active 3 User defined resistor type 4 VDO 5 SGH (yellow river sensor) 6 SGD (Dongkang sensor) 7 CURTIS 8 DATCON 9 VOLVO-EC 10 SGX 120 DEGREE	<p>Digital input is switch value signal; low or high electrical level can be selected to be active, connecting to earth point will mean that low electrical level is selected, hang in air means high electrical level is selected; cannot be connected to power supply positive.</p> <p>The range of user-defined resistor type sensor is 0-6000 Ohm, by default SGD sensor is selected.</p>
2	Oil Pressure Sensor	0 Not used 1 Low digital input is active 2 High digital input is active 3 User defined resistor type 4 VDO 10Bar 5 SGH (yellow river sensor) 6 SGD(Dongkang sensor) 7 CURTIS 8 DATCON 10Bar 9 VOLVO-EC 10 SGX 10Bar	<p>Digital input is switch value signal; low or high electrical level can be selected to be active, connecting to earth point will mean that low electrical level is selected, hang in air means high electrical level is selected; cannot be connected to power supply positive.</p> <p>The range of user-defined resistor type sensor is 0-6000 Ohm, by default SGD sensor is selected.</p>
3	Fuel Level Sensor	0 Not used 1 Low digital input is active 2 High digital input is active 3 User defined resistor type 4 SGH (yellow river sensor) 5 SGD (Dongkang sensor) 6 Reserved 1 7 Reserved 2	<p>Digital closed and Digital open both are digital signal; low or high electrical level can be selected to be active, connecting to earth point will mean that low electrical level is selected, hang in air means high electrical level is selected; cannot be connected to power supply positive.</p> <p>The range of user-defined resistor type sensor is 0-6000 Ohm, by default "Not used" is selected</p> <p>Before selecting fuel level sensor type, digital input type must be set as 8.</p>



7.5 CONDITIONS OF CRANK DISCONNECT (TABLE 5)

No	Content
0	Speed
1	Generator Frequency
2	Speed + Generator Frequency
3	Speed + Oil pressure
4	Generator Frequency + Oil pressure
5	Generator Frequency + Speed+ Oil pressure
6	Oil pressure





- 1) There are 3 conditions to make starter separate with engine; Speed, generator frequency and oil pressure can be used separately while oil pressure is recommended to use together with speed and generator frequency. The aim is to disconnect the starter motor as soon as possible.
- 2) Speed sensor is the magnetic equipment which be installed in starter for detecting flywheel teeth.
- 3) When set as speed, must ensure that the number of flywheel teeth is as same as setting, otherwise, "over speed shutdown" or "under speed shutdown" may be caused.
- 4) If genset without speed sensor please don't select corresponding items, otherwise, "start fail" or "loss speed signal" maybe caused.
- 5) If genset without oil pressure sensor, please don't select corresponding items.
- 6) If not select generator frequency in crank disconnect setting, controller will not collect and display the relative power quantity (can be used in water pump set); if not select speed in crank disconnect setting, the rotating speed displayed in controller is calculated by generator signal.

8. CONTROLLER FUNCTION SETTING

8.1. PARAMETER SETTING

Hold and press  for 2s to enter into password interface, and the fist digit is blinking as follows,



- 1) Press  button to increase the value of the blinking digit and  to decrease the value; when the first digit is set, press  to move the cursor;
- 2) Repeat the same procedure to set the digits from 2nd to 4th;
- 3) If the password is right, enter into the parameter configuration interface (as shown below) which including the serial number of the set items and their parameters; press  to scroll down and  to scroll up;





- 4) Press  to set the current item, and when the first digit starts blinking, use the same way that is used for password to enter the set value.

Attention:



- a) Please change the controller parameters when generator is in standby mode only (e. g. Crank disconnect conditions selection, configurable input, configurable output, various delay), otherwise, shutdown and other abnormal conditions may happen.
- b) Serial number of parameters please reference *Table1*
- c) The value of each parameter can be set only within a certain range.
- d) Over voltage set value must be higher than under voltage set value, otherwise over voltage and under voltage condition may occur simultaneously.
- e) Over speed set value must be higher than under speed set value, otherwise over speed and under speed condition may occur simultaneously.
- f) Please set the generator frequency value as low as possible when cranking, in order to make the starter be separated quickly as soon as crank disconnect.
- g) Before selecting fuel level sensor type, it is necessary to set a configurable input port type as 8.
- h) At any time press  can stop current parameter setting immediately.

8.2. LCD CONTRAST ADJUSTMENT

When genset is in standby status, simultaneously hold and press  and  keys for 2s to enter into LCD contrast adjustment interface, and LCD contrast increases one level every 1s without releasing buttons. There are 6 levels to select as requirement.



8.3. GENERATOR FLYWHEEL TEETH AUTOMATIC ADJUSTMENT

In manual mode, if crank disconnect conditions select as “2 Speed + Generator Frequency” or “Speed + Generator Frequency + Oil Pressure” (generator frequency and speed are not 0), controller will automatic adjustment generator flywheel teeth based on gen frequency and poles when simultaneous press  and  keys.



9. SENSOR SETTINGS CLARIFICATION

- a) Sensors are connected to the controller are all resistor type. Parts of build-in standard sensor curves in the controller can be selected by users via PC software.(details please to see *Table4*)
- b) When input the sensor curve, X value (resistor) must be input from small to large, otherwise, mistake occurs.
- c) If select sensor type is set as “not used”, sensor curve is not working and LCD display “---”.
- d) If there is only has low oil pressure alarm switch only and without oil pressure sensor, pressure sensor can be set as “low digital input is active” or “high digital input is active”.
- e) The headmost or backmost values in the vertical coordinates can be set as same as below,

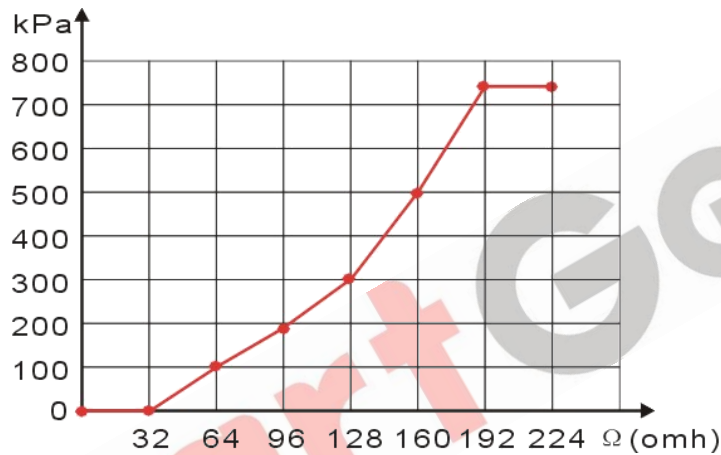

Normal Pressure Unit Conversion Table

	N/m ² Pa	kgf/cm ²	bar	psi
1Pa	1	1.02x10 ⁻⁵	1x10 ⁻⁵	1.45x10 ⁻⁴
1kgf/cm ²	9.8x10 ⁴	1	0.98	14.2
1bar	1x10 ⁵	1.02	1	14.5
1psi	6.89x10 ³	7.03x10 ⁻²	6.89x10 ⁻²	1



10. COMMISSIONING

Please make sure the following checks are made before commissioning,

- 1) Ensure all the connections are correct and wires diameter is suitable.
- 2) Ensure that the controller DC power has fuse, controller's positive and negative connected to start battery are correct.
- 3) Take proper action to prevent engine to crank success (e. g. Remove the connection wire of fuel valve). If checking is OK, make the start battery power on; choose manual mode and controller will executive routine.
- 4) Set controller under manual mode, press "start" button, genset will start. After the cranking times as setting, controller will send signal of Start Failure; then press "stop" to reset controller.
- 5) Recover the action to prevent engine to crank success (e. g. Connect wire of fuel valve), press start button again, genset will start. If everything goes well, genset will normal running after idle running (if idle run be set). During this time, please watch for engine's running situations and AC generator's voltage and frequency. If abnormal, stop genset and check all wires connection according to this manual.
- 6) Any other questions please contact with SmartGen service personnel.

11. TYPICAL APPLICATION

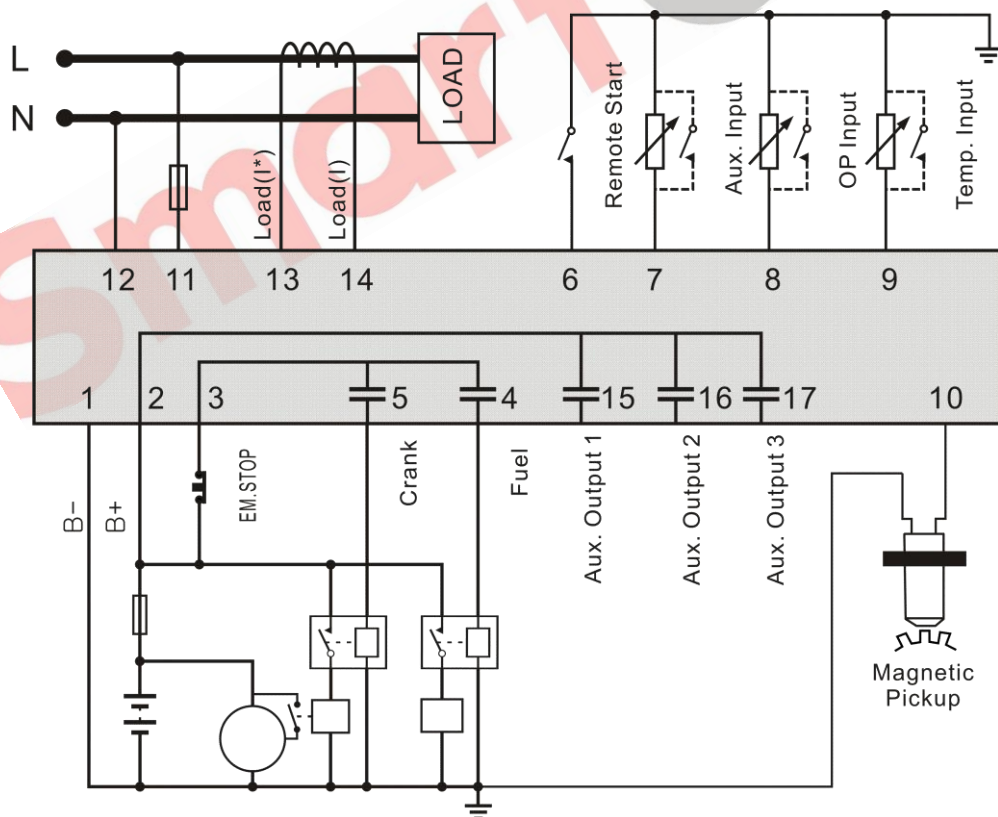

▲ **Caution:** Start and fuel output ports should be select large capacity relays.

▲ **Caution:** When sensor port configured as "high digital input is active", hang in air means high electrical level is selected; cannot be connected to power supply positive.



12. INSTALLATION

12.1.FIXING CLIPS

- 1) Controller is panel built-in design; it is fixed by clips when installed.
- 2) Withdraw the fixing clip screw (turn anticlockwise) until it reaches proper position.
- 3) Pull the fixing clip backwards (towards the back of the module) ensuring two clips are inside their allotted slots.
- 4) Turn the fixing clip screws clockwise until they are fixed on the panel.

▲ Note: Care should be taken not to over tighten the screws of fixing clips.

12.2.OVERALL DIMENSION

Overall and cutout dimensions as follows,

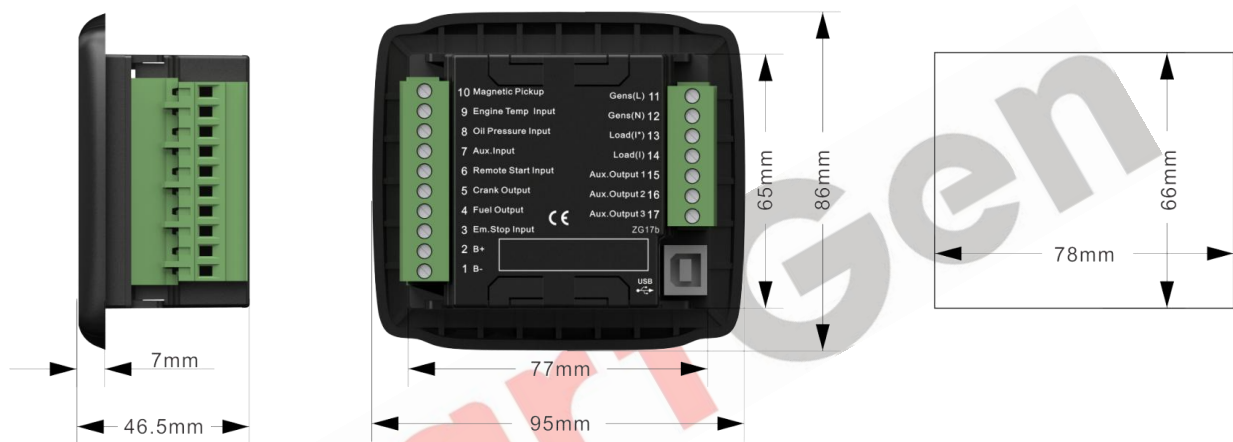

— BATTERY VOLTAGE INPUT

HGM1790N series controller can suit for widely range of battery voltage DC(8~35)V. Negative of battery must be connected with the engine shell. Diameter of wire that connects from power supply to battery must be over 1.5mm². If floating charge configured, please firstly connect output wires of charger to battery's positive and negative directly, then, connect wires from battery's positive and negative to controller's positive and negative input ports in order to prevent charge disturbing the controller's normal working.

— SPEED SENSOR INPUT

Speed sensor is the magnetic equipment which be installed in starter and for detecting flywheel teeth. Its connection wires to controller should apply for 2 cores shielding line. The shielding layer should connect to No. 1 terminal in controller while another side is hanging in air. The else two signal wires are connected to No.1 and No.10 terminals in controller. The output voltage of speed sensor should be within AC(1~24)V (effective value) during the full speed. AC12V is recommended (in rated speed). When install the speed sensor, let the sensor is spun to contacting flywheel first, then, port out 1/3 lap, and lock the nuts of sensor at last.

— OUTPUT AND EXPAND RELAYS



All outputs of controller are relay contact output type. If need to expand the relays, please add freewheel diode to both ends of expand relay's coils (when coils of relay has DC current) or, increase resistance-capacitance return circuit (when coils of relay has AC current), in order to prevent disturbance to controller or others equipment.

— AC INPUT

Current input of controller must be connected to outside current transformer. And the current transformer's secondary side current must be 5A. At the same time, the phases of current transformer and input voltage must correct. Otherwise, the current of collecting and active power maybe not correct.

▲NOTE: When there is load current, transformer's secondary side prohibit open circuit.

— WITHSTAND VOLTAGE TEST

When controller had been installed in control panel, if need the high voltage test, please disconnect controller's all terminal connections, in order to prevent high voltage into controller and damage it.



13. FAULT FINDING

Symptoms	Possible Solutions
Controller no response with power.	Check starting batteries; Check controller connection wirings; Check DC fuse.
Genset shutdown	Check the water/cylinder temperature is too high or not; Check the genset AC voltage; Check DC fuse.
Low oil pressure alarm after crank disconnect	Check the oil pressure sensor and its connections.
High water temp. alarm after crank disconnect	Check the temperature sensor and its connections.
Shutdown Alarm in running	Check related switch and its connections according to the information on LCD; Check programmable inputs.
Crank not disconnect	Check fuel oil circuit and its connections; Check starting batteries; Check speed sensor and its connections; Refer to engine manual.
Starter no response	Check starter connections; Check starting batteries.