



SmartGen
ideas for power

HGM8100N

(HGM8110V_ 8120V_ 8110L_ 8120L_ 8110CAN_ 8120CAN)

GENSET CONTROLLER

USER MANUAL



SMARTGEN (ZHENGZHOU) TECHNOLOGY CO., LTD.

CONTENTS

1 OVERVIEW	6
2 MOUDLES COMPARISON	7
3 PERFORMANCE AND CHARACTERISTICS	8
4 SPECIFICATION OPERATION	10
5 OPERATION	11
5.1 INDICATORS	11
5.2 KEY FUNCTION	11
5.3 LCD DISPLAY	13
5.3.1. MAIN DISPLAY	13
5.3.2. PARARMETERS SETTING MANUAL	15
5.3.3. PARAMETER SETTINGS	15
5.4 AUTO START/STOP OPERATION.....	16
5.5 MANUAL START/STOP OPERATION.....	17
5.6 SWITCH CONTROL PROCEDURES	18
5.6.1. HGM8120N SWITCH CONTROL PROCEDURES.....	18
5.6.1.1 MANUAL TRANSFER PROCEDURES	18
5.6.1.2 AUTO TRANSFER PROCEDURES.....	18
5.6.2. HGM8110N SWITCH CONTROL PROCEDURES.....	19
5.6.2.1 MANUAL CONTROL PROCEDURES.....	19
5.6.2.2 AUTO CONTROL PROCEDURES.....	19
6 PROTECTION	20
6.1 WARNINGS	20
6.2 SHUTDOWN ALARM	22
6.3 TRIP AND STOP ALARM	24
6.4 TRIP ALARM.....	24
7 WIRINGS CONNECTION.....	25
8 SCOPES AND DEFINITIONS OF PROGRAMMABLE PARAMETERS.....	28
8.1 CONTENTS AND SCOPES OF PARAMETERS.....	28
8.2 ENABLE DEFINITION OF PROGRAMMABLE OUTPUT PORTS	36
8.2.1. ENABLE DEFINITION OF PROGRAMMABLE OUTPUT PORTS FORM	36
8.2.2. CUSTOM PERIOD OUTPUT	40
8.2.3. CUSTOM COMBINED OUTPUT.....	40
8.3 DEFINED CONTENTS OF CONFIGURABLE INPUT PORTS.....	41
8.4 SELECTION OF SENSORS.....	43
8.5 CONDITIONS OF CRANK DISCONNECT SELECTION.....	44
9 PARAMETERS SETTING	44
10 SENSORS SETTING.....	45
11 COMMISSIONING	46
12 TYPICAL APPLICATION.....	47

13 INSTALLATION	49
13.1 OVERALL DIMENSION	49
13.2 BATTERY VOLTAGE INPUT	49
13.3 SPEED SENSOR INPUT	49
13.4 OUTPUT AND EXPAND RELAYS	49
13.5 AC INPUT	49
13.6 WITHSTAND VOLTAGE TEST	50
14 GSM SHORT MESSAGE ALARM AND REMOTE CONTROL.....	51
14.1 GSM SHORT MESSAGE ALARM.....	51
14.2 GSM SHORT MESSAGE REMOTE CONTROL.....	51
15 CONNECTIONS OF CONTROLLER WITH J1939 ENGINE.....	52
15.1 CUMMINS ISB/ISBE.....	52
15.2 CUMMINS QSL9.....	52
15.3 CUMMINS QSM11(import)	53
15.4 CUMMINS QSX15-CM570	53
15.5 CUMMINS GCS-MOVBUS.....	53
15.6 CUMMINS QSM11	54
15.7 CUMMINS QSZ13	54
15.8 DETROIT DIESEL DDEC III / IV.....	54
15.9 DEUTZ EMR2.....	55
15.10JOHN DEERE.....	55
15.11MTU MDEC.....	55
15.12MTU ADEC(SMART MODULE).....	55
15.13MTU ADEC (SAM MODULE)	56
15.14PERKINS	56
15.15SCANIA	56
15.16VOLVO EDC3.....	57
15.17VOLVO EDC4.....	57
15.18VOLVO-EMS2.....	57
15.19YUCHAI	58
15.20WEICHAI	58
16 ETHERNET INTERFACE	59
16.1 ETHERNET INTERFACE INTRODUCTION	59
16.2 NETWORK CLIENT MODE.....	59
16.3 CONTROLLER AND NETWORK CABLE CONNECTION.....	59
17 FAULT FINDING.....	60



Chinese trademark

SmartGen English trademark

SmartGen — make your generator *smart*

SmartGen Technology Co., Ltd.

No.28 Jinsuo Road

Zhengzhou

Henan Province

P. R. China

Tel: 0086-371-67988888/67981888

0086-371-67991553/67992951

0086-371-67981000(overseas)

Fax: 0086-371-67992952

Web: <http://www.smartgen.com.cn>

<http://www.smartgen.cn>

Email: sales@smartgen.cn

All rights reserved. No part of this publication may be reproduced in any material form (including photocopying or storing in any medium by electronic means or other) without the written permission of the copyright holder.

Applications for the copyright holder's written permission to reproduce any part of this publication should be addressed to Smartgen Technology at the address above.

Any reference to trademarked product names used within this publication is owned by their respective companies.



SmartGen Technology reserves the right to change the contents of this document without prior notice.

Table 1 Software Version

Date	Version	Note
2016-07-24	1.0	Original release.

This manual is suitable for HGM8110V, HGM8120V, HGM8110L, HGM8110CAN, HGM8120CAN controllers only.

Table 2 Notation Clarification

SIGN	INSTRUCTION
 NOTE	Highlights an essential element of a procedure to ensure correctness.
 CAUTION!	Indicates a procedure or practice, which, if not strictly observed, could result in damage or destruction of equipment.
 WARNING!	Indicates a procedure or practice, which could result in injury to personnel or loss of life if not followed correctly.

SmartGen

1 OVERVIEW

HGM8100N series genset controllers are especially designed for extremely high/low temperature environment (-40~+70)°C. The controllers can operate reliability in extreme temperature conditions with the help of VFD display or LCD and the components that resist extreme temperature. Controller has strong ability of anti-electromagnetic interference, can be used under complex electromagnetic interference environment. It is easy to maintain and upgrade due to the plug-in terminal. All display information is Chinese (also can be set as English or other languages).

HGM8100N series genset controllers integrate digitization, intelligitization and network technology which are used for genset automation and monitor control system of single unit to achieve automatic start/stop, data measure, alarm protection and “three remote” functions(remote control, remote measuring and remote communication).

HGM8100N series genset controllers adopt 32-bit micro-processor technology with precision parameters measuring, fixed value adjustment, time setting and set value adjusting and etc. Majority parameters can be configured from front panel, and all parameters can be configured by PC via RS485 interface or ETHERNET to adjust and monitor. It can be widely used in all types of automatic genset control system with compact structure, advanced circuits, simple connections and high reliability.

SmartGen

2 MOUDLES COMPARISON

HGM8100N series controller include HGM8110V, HGM8120V, HGM8110L, HGM8120L, HGM8110CAN and HGM8120CAN.

HGM8100N been collectively named of HGM8110V, HGM8110L and HGM8110CAN.

HGM8120N been collectively named of HGM8120V, HGM8120L and HGM8120CAN.

Table 3 Moudles Comparison

	HGM8110V	HGM8120V	HGM8110 CAN	HGM8120CAN	HGM8110L	HGM8120L
Display	VFD			LCD (heatable)		
Mains Monitoring		•		•		•
Input Number	8	8	8	8	8	8
Output Number	8	8	8	8	8	8
Sensor Number	5	5	5	5	5	5
Earth Current	•	•	•	•	•	•
Schedule Function	•	•	•	•	•	•
RS485	•	•	•	•	•	•
ETHERNET			•	•		
GSM	•	•	•	•	•	•
J1939			•	•		
USB	•	•	•	•	•	•
Real-time Clock	•	•	•	•	•	•
Event Log	•	•	•	•	•	•
Expand Input/Output			•	•		

NOTE:

- 1) **Two fixed output ports: start output and fuel output.**
- 2) **Analog quantity sensor consists of three fixed sensors (temperature sensor, pressure sensor and fuel level sensor) and two flexible sensors.**

3 PERFORMANCE AND CHARACTERISTICS

HGM8110N: used for single automation systems. Control genset start/stop through remote signals control.

HGM8120N: AMF (Auto Mains Failure), updates based on HGM8110N, moreover, has mains electric quantity monitoring and mains/generator automatic transfer control function, especially for automatic system composed by generator and mains.

- 1) With ARM-based 32-bit SCM, highly integrated hardware, new reliability level.
- 2) Vacuum fluorescent display (VFD) or LCD display(able to control heating according to the environment temperature), selectable Chinese/English interface which can be chosen at the site, making commissioning convenience for factory personnel.
- 3) LCD adopts hard screen acrylic material with good wear-resisting and scratch-resisting.
- 4) Silicone panel and pushbuttons can be used in extreme temperature environment.
- 5) RS485 communication interface enable “Three remote functions” (remote control, remote measuring and remote communication) according to MODBUS protocol.
- 6) Ethernet monitoring can be realized via ETHERNET communication interface (need controller with Ethernet interface).
- 7) Equipped with SMS (Short Message Service) function. When genset is alarming, controller can send short messages via SMS automatically to max. 5 telephone numbers. Besides, generator status can be controlled and checked using SMS.
- 8) Equipped with CANBUS port and can communicate with J1939 genset. Not only can monitor frequently-used data (such as water temperature, oil pressure, speed, fuel consumption and so on) of ECU machine, but also control starting up, shutdown , raising speed and speed droop via CANBUS port (need controller with CANBUS interface).
- 9) Suitable for 3-phase 4-wire, 3-phase 3-wire, single phase 2-wire, and 2-phase 3-wire systems with voltage 120/240V and frequency 50/60Hz.
- 10) Collects and shows 3-phase voltage, current, power parameter and frequency of generator or mains.

Mains

Line voltage (Uab, Ubc, and Uca)
 Phase voltage (Ua, Ub, and Uc)
 Phase sequence
 Frequency Hz

Generator

Line voltage (Uab, Ubc, and Uca)
 Phase voltage (Ua, Ub, and Uc)
 Phase sequence
 Frequency Hz

Load

Current Ia, Ib, Ic
 Each phase and total active power P
 Each phase and total reactive power Q
 Each phase and total apparent power S
 Each phase and average power factor λ
 Accumulate total generator power W
 Earth current I

A (unit)
 kW (unit)
 Kvar (unit)
 kVA (unit)
 1 (unit)
 kWh, kVarh, kVAh (unit)
 A (unit)

- 11) For Mains, controller has over and under voltage, over and under frequency, loss of phase and phase sequence wrong detection functions; for generator, controller has over and under voltage, over and under frequency, loss of phase, phase sequence wrong, over and reverse power, over current functions.
- 12) 3 fixed analog sensors (temperature, oil pressure and liquid level).
- 13) 2 configurable sensors can be set as sensor of temperature, oil pressure or fuel level.

- 14) Precision measure and display parameters about Engine.
 - Temp. (WT) °C/°F both be displayed
 - Oil pressure (OP) kPa/Psi/Bar all be displayed
 - Fuel level (FL) %(unit)
 - Speed (SPD) r/min (unit)
 - Voltage of Battery (VB) V (unit)
 - Voltage of Charger (VD) V (unit)Hour count (HC) can accumulate to max. 65535 hours.
Start times can accumulate to max. 65535 times.
- 15) Protection: automatic start/stop of the gen-set, ATS(Auto Transfer Switch) control with perfect fault indication and protection function.
- 16) All output ports are relay-out;
- 17) Parameter setting: parameters can be modified and stored in internal FLASH memory and cannot be lost even in case of power outage; most of them can be adjusted using front panel of the controller and all of them can be modified using PC via USB, RS485 or ETHERNET ports.
- 18) More kinds of curves of temperature, oil pressure, fuel level can be used directly and users can define the sensor curves by themselves.
- 19) Multiple crank disconnect conditions (speed sensor, oil pressure, generator frequency) are optional.
- 20) Widely power supply range DC(8~35)V, suitable to different starting battery voltage environment;
- 21) Event log, real-time clock, scheduled start & stop generator (can be set as start genset once a day/week/month whether with load or not).
- 22) PLC (Programmable Logic Controller) function. Users can use graphical programming to achieve specific functions.
- 23) Can be used on pumping units and as an indicating instrument (indicate and alarm are enable only, relay is inhibited).
- 24) With maintenance function. Actions (warning, shutdown or trip and stop) can be set when maintenance time out.
- 25) All parameters used digital adjustment, instead of conventional analog modulation with normal potentiometer, more reliability and stability;
- 26) Waterproof security level IP55 due to rubber seal installed between the controller enclosure and panel fascia;
- 27) Metal fixing clips enable perfect in high temperature environment;
- 28) Modular design, anti-flaming ABS plastic enclosure, pluggable connection terminals and embedded installation way; compact structure with easy mounting.
- 29) With accumulative running A、B and accumulative power A、B function, users can eliminate log event and re-accumulating, thus provide convenient for users statistic.

4 SPECIFICATION OPERATION

Table 4 Technical Parameters

Items	Contents
Operating Voltage	DC8.0V to DC35.0V, Continuous Power Supply.
Power Consumption	<4W (standby ≤2W)
Alternator Input Range	
3Phase 4Wire	AC15V-AC 360V (ph-N)
3Phase 3Wire	AC30V - AC620V (ph-ph)
Single Phase 2Wire	AC15V - AC360V (ph-N)
2Phase 3Wire	AC15V - AC360V (ph-N)
Alternator Frequency	50 Hz /60Hz
Speed sensor voltage	1.0V to 24.0V (RMS)
Speed sensor Frequency	10,000 Hz (max.)
Start Relay Output	16 A DC28V at supply output
Fuel Relay Output	16 A DC28V at supply output
Programmable Relay Output (1)	7 A DC28V at supply output
Programmable Relay Output (2)	7 A DC28V at supply output
Programmable Relay Output (3)	7A DC28V at supply output
Programmable Relay Output (4)	7A AC250V voltage free output
Programmable Relay Output (5)	8 A AC250V voltage free output
Programmable Relay Output (6)	8 A AC250V voltage free output
Case Dimension	242mm x186mm x53mm
Panel Cutout	214mm x160mm
CT Secondary Current	5A rated
Working Conditions	Temperature: (-40~+70)°C; Humidity: (20~93)%RH
Storage Condition	Temperature: (-40~+70)°C
Protection Level	IP55 Gasket
Insulating Intensity	Apply AC2.2kV voltage between high voltage terminal and low voltage terminal; The leakage current is not more than 3mA within 1min.
Net Weight	0.85kg

5 OPERATION

5.1 INDICATORS

Table 5 Alarm Indicators

Alarm Type	Alarm Indicator
No Alarm	Indicator off
Warning	Slow flashing(1time/s)
Trip Alarm	Slow flashing(1time/s)
Shutdown Alarm	Fast flashing(5 times/s)
Trip and Stop Alarm	Fast flashing(5 times/s)











Status indicator: illuminated from crank disconnect to ETS while off during other periods.







Gens normal Indicator: It is light on when generator is normal; flashing when generator state is abnormal; off when there is no generator power.



Mains normal Indicator: It is light on when mains is normal; flashing when mains state is abnormal; off when there is no mains power.

5.2 KEY FUNCTION

Table 6 Key Function Descriptions

Icon	Key	Description
	Stop	Stop running generator in Auto/Manual mode; Lamp test (press at least 3 seconds); Reset alarm in stop mode; During stopping process, press this button again to stop generator immediately.
	Start	Start genset in Manual mode.
	Manual Mode	Press this key and controller enters in Manual mode.
	Auto Mode	Press this key and controller enters in Auto mode.
	Mute/Reset Alarm	Alarming sound off; If there is trip alarm, pressing the button at least 3 seconds can reset this alarm.
	Gen Close/Open	Can control generator to switch on or off in manual mode. (HGM8110N without)
	Mains Close/Open	Can control generator to switch on or off in manual mode. (HGM8110N without).
	Close	Can close breaker in manual mode (HGM8120N without)
	Open	Can open breaker in manual mode (HGM8120N without)
	Set	Enter setting interface

	Up/Increase	1) Screen scroll; 2) Up cursor and increase value in setting menu.
	Down/Decrease	1) Screen scroll; 2) Down cursor and decrease value in setting menu.
	Left	1) Screen scroll; 2) Left move cursor in setting menu.
	Right	1) Screen scroll; 2) Right move cursor in setting menu.
	Confirm	In settings menu confirms the set value.
	Exit	1. Returns to the previous screen; 2. In settings menu returns to the upper level menu.



▲NOTE: In manual mode, pressing  and  simultaneously will force generator to crank. Successful start will not be judged according to crank disconnect conditions, operator will have to crank the starter motor manually; when operator decides that the engine has fired, he/she should release the button and start output will be deactivated, safety on delay will start.

▲WARNING: Default password is 00318, user can change it in case of others change the advanced parameters setting. Please clearly remember the password after changing.

If you forget it, please contact SmartGen services and send PD information in the controller page of “ABOUT” to us.

5.3 LCD DISPLAY

5.3.1. MAIN DISPLAY

Main screen show pages; use  to scroll the pages and  to scroll the screen.

★**Main Screen**, including as below,

Gen: voltage, frequency,

Load: current, active power, reactive power

Mains: voltage, frequency

Engine: speed, temperature, oil pressure

▲**NOTE: HGM8110N has no mains correlative values: it will circulatory scroll pages if no action after enter the main display.**

★**Status**, including as below,

Status of genset, mains, and ATS

▲**NOTE: HGM8110N has no mains status screen.**

★**Engine**, including as below,

Speed, temperature of engine, engine oil pressure, fuel level, Configure Sensor 1, Configure Sensor 2, battery voltage, charger voltage, accumulated run time, accumulated start times, user A and user B accumulated start times.

▲**NOTE: If connected with J1939 engine via CANBUS port, this page also includes: coolant pressure, coolant level, fuel temperature, fuel pressure, inlet temperature, exhaust temperature, turbo pressure, total fuel consumption and so on. (Different engine with different parameters)**

★**Gen**, including as below,

Phase voltage, Line voltage, frequency, phase sequence

★**Load**, including as below

Current, each phase and total active power (positive and negative), each phase and total reactive power (positive and negative), each phase and total apparent power, each phase and average power factor (positive and negative), accumulated energy earth current and user A and user B accumulated energy.

▲**NOTE: Power factor shows as following,**

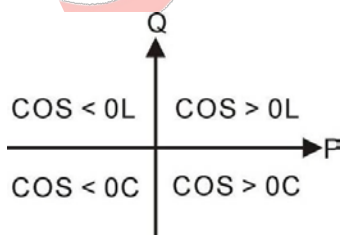

Remark:

P stands for active power

Q stands for inactive power

Table 7 Power Factor Descriptions

Power factor	Conditions	Active power	Inactive power	Remark
COS>0L	P>0,Q>0	Input	Input	Load is inductive resistance.
COS>0C	P>0,Q<0	Input	Output	Load is capacitance resistance.
COS<0L	P<0,Q>0	Output	Input	Load equal to one under excitation generator
COS<0C	P<0,Q<0	Output	Output	Load equal to one over excitation generator.

Remark:

1. Input active power, generator or mains supply electricity to load.
2. Output active power, load supply electricity to generator or mains.
3. Input reactive power, generator or mains send reactive power to load.
4. Output reactive power, load send reactive power to generator or mains.

★**Mains**, including as below,

Phase voltage, Line voltage, frequency, phase sequence

▲**Note:** HGM8100N without mains page.

★**Alarm:**

Display all alarm information, including alarm, alarm shutdown, trip shutdown and trip without shutdown.

▲**NOTE:** For ECU alarms and shutdown alarms, if the alarm information is displayed, check engine according to it, otherwise, please check the manual of generator according to SPN alarm code.

★**Event log**

Records all start/stop events (shutdown alarm, trip and shutdown alarm, manual /auto start or stop) and the real time when alarm occurs.

★**Others**, including,

Time and Date, count down time for maintenance, input/output ports status, NET status etc.

★**About**, including,

Issue time of software and hardware version and PD number of controller.

5.3.2. PARARMETERS SETTING MANUAL

Press and hold  for more than 3 seconds to enter user menu;

Parameter: After entering the correct password (factory default password is 00318) you can enter parameter settings screen.

Language: Selectable Chinese, English and others (default: Espanol)

Commissioning: On load, off load and custom commissioning are optional. Custom commissioning can configure on load or not during commissioning, when to commissioning and select the mode after commissioning (manual mode, auto mode and stop mode).

Clear users' accumulation: Can clear total run time A and B, total electric energy A and B.

5.3.3. PARAMETER SETTINGS

- Mains settings
- Timer settings
- Engine settings
- Generator settings
- Load settings
- Switch settings
- Temperature sensor settings
- Oil pressure sensor settings
- Level sensor settings
- Aux. sensor1 settings
- Aux. sensor2 settings
- Switch input settings
- output port settings
- Module settings
- Scheduling and maintenance settings
- GSM settings
- Extension module settings

▲NOTE: Pressing  can exit setting directly during setting.

5.4 AUTO START/STOP OPERATION

Press , its indicator lights, and controller enters **Auto** mode.

Starting Sequence,







- 1) **HGM120N:** When Mains is abnormal (over and under voltage, over and under frequency, loss of phase, phase sequence wrong), it enters into mains “abnormal delay” and LCD display count down time. When mains abnormal delay is over, it enters into “start delay”; it also enters into this mode when “remote start on load” is active.
- 2) **HGM8110N:** Generator enters into “start delay” as soon as “Remote Start on Load” is active.
- 3) Start Delay timer is shown on LCD.
- 4) When start delay is over, preheat relay outputs (if this be configured), “preheat start delay XX s” is shown on LCD.
- 5) When preheat delay is over, fuel relay outputs 1s and then start relay output; if engine crank fails during “cranking time”, the fuel relay and start relay deactivated and enter into “crank rest time” to wait for next crank.
- 6) If engine crank fails within setting times, the controller sends Fail to Start signals and Fail To Start message appears on LCD alarm page.
- 7) In case of successful crank attempt, “safety on timer” starts. During this period, low oil pressure, high water temperature, under speed, charge failure alarms are disabled. As soon as this delay is over, “start idle delay” is initiated (if configured).
- 8) During “start idle delay”, under speed, under frequency, under voltage alarms are inhibited. When this delay is over, “warming up delay” starts (if configured).
- 9) When “warming up delay” is over, if generator state is normal, its indicator will be illuminated. If voltage and frequency has reached on-load requirements, the closing relay will be energized, generator will accept load, generator power indicator will turn on, and generator will enter Normal Running state; if voltage and frequency are abnormal, the controller will initiate alarm (alarm type will be displayed on LCD alarm page).

▲NOTE: In case of “Remote Start (off Load)”, the procedure is the same, except for step NO. 9: the closing relay will NOT be energized, generator will NOT accept load.

Stopping Sequence:

- 1) HGM120N, when mains return normal during gen-set running, enters into mains voltage “Normal delay”. When mains normal delay are over, enter into “stop delay”; also can be into this mode when “remote start on load” is inactive.
- 2) HGM8110N, generator enters into “stop delay” as soon as “Remote Start on Load” is inactive.
- 3) When stop delay is over, close generator relay is un-energized; generator enters into “cooling down time”. After “transfer rest time”, close mains relay is energized. Generator indicator extinguish while mains indicator lights.
- 4) Idle relay is energized as soon as entering “stop idle delay”.
- 5) If enter “ETS hold delay”, ETS relay is energized. Fuel relay is deactivated and decides whether generator is stopped or not automatically.
- 6) Then enter gen-set “Fail to stop time”, auto decides whether generator is stopped or not automatically.
- 7) Enter “after stop time” (if configured) as soon as generator stops. Otherwise, controller will send “Fail to stop” alarm. (If gen-set stopped successfully after warning of “Failed to Stop”, it will enter “after stop time” and remove alarm)
- 8) Enter “generator at rest” as soon as “after stop time” is over.

5.5 MANUAL START/STOP OPERATION

- 1) **MANUAL START:** Press , controller enters into Manual mode and its indicator lights. Press  to start generator, can automatically detect crank disconnected, and generator accelerates to high-speed running automatically. With high temperature, low oil pressure and abnormal voltage during generator running, controller can protect genset to stop quickly. Press  (HGM8120N) or press  and  (HGM8110N) to open or close the switch. (Please refer to No.4~9 of Auto start operation for detail procedures, which the difference is only in the way of switch open and close).
- 2) **MANUAL STOP:** Press  can stop the running generators. (Please refer to No.3~8 of Auto stop operation for detail procedures).

▲Note: In “manual mode”, the procedures of ATS please refer to ATS procedure of generator in this manual.

SmartGen

5.6 SWITCH CONTROL PROCEDURES



5.6.1. HGM8120N SWITCH CONTROL PROCEDURES



5.6.1.1 MANUAL TRANSFER PROCEDURES

When controller is in **Manual** mode, the switch control procedures will start through manual transfer.





Users can control the loading transfer of ATS via pressing button to switch on or off.

A. If “Open breaker detect” is “SELECT Disable”

Press generator switch on or off key   if generator has taken load, will send unload signals; if taken no load, generator will send load signals; if mains has taken load, mains will unload, and then generator will take load.

Press mains switch on or off key  , if mains has taken load, will send unload signals; if taken no load, mains will send load signals; if generator has taken load, generator will unload, and then mains will take load.

B. If “Open breaker detect” is “SELECT Enable”

To transfer load from mains to generator need to press mains switch off key   firstly. After switch off delay, press generator switch on key  , and generator will take load (there is no action when pressing switch on key directly).

The way to transfer from generator to mains is as same as above.

5.6.1.2 AUTO TRANSFER PROCEDURES

When controller is in **AUTO** mode, switch control procedures will start through automatic transfer.

1) If input port is configured as Close Mains Auxiliary

A. If “Open breaker detect” is “SELECT Enable”

When transferring load from mains to generator, controller begins detecting “fail to transfer”, then the open delay and transfer rest delay will begin. When detecting time out, if switch open failed, the generator will not switch on, otherwise, generator switch on. Detecting transfer failure while generator switch on. When detecting time out, if switch on fail, it is need to wait for generator to switch on. If transfer failed and warning “SELECT Enable”, there is alarming signals whatever switch on or off failure.

The way to transfer from generator load to mains load is as same as above.

B. If “Open breaker detect” is “SELECT Disable”

Mains load is transferred into generator load, after the delay of switch off and transfer interval, generator switch on. Detecting transfer fail while generator switches on. After detecting time out, if switch on fail, then wait for generator switch on. If transfer fail and warning “SELECT Enable”, there is alarming signals.

2) If input port is not configured as Close Mains Auxiliary

Mains load is transferred into generator load, after switch off and transfer interval delay, generator switch on.



The way to transfer generator load to mains load is as same as above.

5.6.2. HGM8110N SWITCH CONTROL PROCEDURES

5.6.2.1 MANUAL CONTROL PROCEDURES

When controller is in Manual mode, manual control will be executive.

Users can control switch on or off by pressing key.

Press generator switch on key , generator will output load signals. Press generator switch off key , generator will output unload signals.

5.6.2.2 AUTO CONTROL PROCEDURES

When controller is in auto mode, switch control procedures will start auto transfer.

1) If input port is configured as Close Mains Auxiliary

A. If “Open breaker detect” is “SELECT Enable”

Generator load is transferred into generator un-load, after the delay of switch off, detecting transfer failure while switch off output. When detecting time out, if switch off failed, it will wait for switch off. Otherwise, switch off is completed.

Generator unload is transferred into generator load, after the delay of switch on, detecting transfer failure while switch on outputting. When detecting time out, if switch on failed, it will wait for switch on. Otherwise, switch on is completed.

If transfer failed and warning “SELECT Enable”, there is alarming signals whatever switch on or off failure.

B. If “Open breaker detect” is “SELECT Disable”

Generator load is transferred into generator unload, after the delay of switch off, switch off is completed.

Generator unload is transferred into generator load, after the delay of switch on, detecting transfer failure while switch on outputting. When detecting time out, if switch on failed, to wait for switch on. Otherwise, switch on is completed.

If transfer failure warning is “SELECT Enable”, there is warning signal that “switch on fail”.

2) If input port is not configured as Close Mains Auxiliary

Generator un-load is transferred into generator load, close generator output.

Generator load is transferred into generator un-load, open generator output.

NOTE:

- 1) When using ATS of no interposition, switch off detecting should “SELECT Disable”;
- 2) When using ATS of having interposition, switch off “SELECT Disable” or “SELECT Enable” both are OK. If choose “SELECT Enable”, switch off output should be configured;
- 3) When using AC contactor, switch off “SELECT Enable” is recommended.

6 PROTECTION

6.1 WARNINGS

When controllers detects the warning signals, alarm only and not stop the genset, besides, the VFD displays the warning information.

Table 8 Warning Alarms

No.	Type	Description
1	Over Speed Warn	When controller detects the speed is higher than the set value, it will send warn signals.
2	Under Speed Warn	When controller detects the speed is lower than the set value, it will send warn signals.
3	Loss of Speed Signal Warn	When controller detects the speed is 0 and the action select "Warn", it will send warn signals.
4	Over Frequency Warn	When controller detects the frequency is higher than the set value, it will send warn signals.
5	Under Frequency Warn	When controller detects the frequency is lower than the set value, it will send warn signals.
6	Over Voltage Wan	When controller detects the voltage is higher than the set value, it will send warn signals.
7	Under Voltage Warn	When controller detects the voltage is lower than the set value, it will send warn signals.
8	Over Current Warn	When controller detects the current is higher than the set value, it will send warn signals.
9	Fail to Stop	When generator not stops after the "stop delay" is over.
10	Charge Alt Fail	When controller detects the charger voltage is lower than the set value, it will send warn signals.
11	Battery Over Voltage	When controller detects the battery voltage is higher than the set value, it will send warn signals.
12	Battery Under Voltage	When controller detects the battery voltage is lower than the set value, it will send warn signals.
13	Maintenance Due	When count down time is 0 and the action select "Warn", it will send warn signals.
14	Reverse Power	When controller detects the reverse power value (power is negative) is lower than the set value, it will send warn signals.
15	Over Power	When controller detects the reverse power value (power is positive) is higher than the set value, it will send warn signals.
16	ECU Warn	When controller gets the alarm signals from engine via J1939, it will send warn signals.
17	Gen Loss of Phase	When controller detects the generator loss phase, it will send warn signals.



No.	Type	Description
18	Gen Phase Sequence Wrong	When controller detects the reverse phase, it will send warn signals.
19	Switch Fail Warn	When controller detects the switch on and off fail, and the action select enable, it will send warn signals.
20	Temp. Sensor Open	When controller detects the sensor is open circuit, and the action select "warn", it will send warn signals.
21	High Temp. Warn	When controller detects the temperature is higher than the set value, it will send warn signals.
22	Low Temp. Warn	When controller detects the temperature is lower than the set value, it will send warn signals.
23	Pressure Sensor Open	When controller detects the sensor is open circuit, and the action select "warn", it will send warn signals.
24	Low OP Warn	When controller detects the oil pressure is lower than the set value, it will send warn signals.
25	Level Sensor Open	When controller detects the sensor is open circuit, and the action select "warn", it will send warn signals.
26	Low Level Warn	When controller detects the oil level is lower than the set value, it will send warn signals.
27	Flexible Sensor 1 Open	When controller detects the sensor is open circuit, and the action select "warn", it will send warn signals.
28	Flexible Sensor 1 High	When controller detects the sensor value is higher than the max. set value, it will send warn signals.
29	Flexible Sensor 1 Low	When controller detects the sensor value is lower than the min. set value, it will send warn signals.
30	Flexible Sensor 2 Open	When controller detects the sensor is open circuit, and the action select "warn", it will send warn signals.
31	Flexible Sensor 2 High	When controller detects the sensor value is higher than the max. set value, it will send warn signals.
32	Flexible Sensor 2 Low	When controller detects the sensor value is lower than the min. set value, it will send warn signals.
33	Digital Input Warn	When digit input port is set as warning and active, controller sends corresponding warning signals.
34	GSM Com Fail	When select GSM enable but the controller couldn't detect GSM model, controller sends corresponding warning signals.
35	Earth Fault	When controller detects earth current is greater than value of setting, and the action "Warning" alarm is set, it will send a "warning" alarm signals.

6.2 SHUTDOWN ALARM

When controller detects shutdown alarm, it will send signals to stop the generator.

Table 9 Shutdown Alarms

No.	Type	Description
1	Emergency Stop	When controller detects emergency stop signals, it will send stop signals.
2	Over Speed	When controller detects the speed value is higher than the set value, it will send stop signals.
3	Under Speed	When controller detects the speed value is lower than the set value, it will send stop signals.
4	Loss Of Speed Signal	When controller detects speed value equals to 0, and the action select "Shutdown", it will send stop signals
5	Over Frequency	When controller detects the frequency value is higher than the set value, it will send stop signals.
6	Under Frequency	When controller detects the frequency value is lower than the set value, it will send stop signals.
7	Over Voltage	When controller detects the voltage value is higher than the set value, it will send stop signals.
8	Under Voltage	When controller detects the voltage value is lower than the set value, it will send stop signals.
9	Fail To Start	If genset start failure within setting of start times, controller will send stop signals.
10	Over Current	When controller detects the current value is higher than the set value, it will send stop signals.
11	Maintenance Due	When count down time is 0 and the action select "Shutdown", it will send stop signals.
12	ECU	When controller receives engine shutdown signals via J1939, controller send stop signals.
13	ECU Fail to Communication	After engine start, controller dos not receive data signals, via J1939, controller send stop signals.
14	Reverse Power Shutdown	When controller detects reverse power value (power is negative) is lower than the set value, and the reverse power action select "shutdown", it will send stop signals.
15	Over Power Shutdown	When controller detects reverse power value (power is positive) is higher than the set value, and the reverse power action select "shutdown", it will send stop signals.
16	Temp. Sensor Open	When controller detects sensor is open circuit, and the action select "shutdown", it will send stop signals.



No.	Type	Description
17	High Temp. Shutdown	When controller detects temperature is higher than the set value, it will send stop signals.
18	Pressure Sensor Open	When controller detects sensor is open circuit, and the action select "shutdown", it will send stop signals.
19	Low Oil Pressure	When controller detects oil pressure is lower than the set value, it will send stop signals.
20	Level Sensor Open	When controller detects sensor is open circuit, and the action select "shutdown", it will send stop signals.
21	Flexible Sensor 1 Open	When controller detects sensor is open circuit, and the action select "shutdown", it will send stop signals.
22	Flexible Sensor 1 High	When controller detects the sensor value is higher than the max. set value, it will send stop signals.
23	Flexible Sensor 1 Low	When controller detects the sensor value is lower than the min. set value, it will send stop signals.
24	Flexible Sensor 2 Open	When controller detects sensor is open circuit, and the action select "shutdown", it will send stop signals.
25	Flexible Sensor 2 High	When controller detects the sensor value is higher than the max. set value, it will send stop signals.
26	Flexible Sensor 2 Low	When controller detects the sensor value is lower than the min. set value, it will send stop signals.
27	Digital Input Port	When digital input port is set as shutdown, and the action is active, it will send stop signals.
28	Earth Fault	When controller detects the earth current of genset exceeds preset earth fault threshold and the earth fault action select "shutdown" it will send stop signals.

6.3 TRIP AND STOP ALARM

When controller detects trip and stop alarm signals, it will shutdown generator quickly and stop after high speed cooling.

Table 10 Trip and Stop Alarms

No.	Type	Description
1	Over Current	When controller detects the value is higher than the set value, and the action select "trip and stop", it will send trip and stop signals.
2	Maintenance Due	When count down time is 0 and the action select "trip and stop", it will send a trip and stop signals.
3	Reverse Power	When controller detects reverse power value (power is negative) is lower than the set value, and the action select "trip and stop", it will send a trip and stop signals.
4	Over Power	When controller detects the over power value (power is positive) is higher than the set value, and the action select "trip and stop", it will send a trip and stop signals.
5	Digital Input Ports	When digital input port is set as "trip and stop", and the action is active, it will send a trip and stop signals.
6	Earth Fault	When controller detects the earth current of genset exceeds preset earth fault threshold and the earth fault action select "trip and stop" it will send trip and stop signals.

6.4 TRIP ALARM

When controller detects trip alarm, it will break close generator signals quickly, but genset not stop.

Table 11 Trip Alarms

No.	Type	Description
1	Over Current	When controller detects the value is higher than the set value, and the action select "trip", it will send trip signals.
2	Reverse Power	When controller detects reverse power value (power is negative) is lower than the set value, and the action select "trip", it will send a trip signals.
3	Over Power	When controller detects the over power value (power is positive) is higher than the set value, and the action select "trip", it will send a trip signals.
4	Digital Input Ports	When digital input port is set as "trip", and the action is active, it will send a trip signals.
5	Earth Fault	When controller detects the earth current of genset exceeds preset earth fault threshold and the earth fault action select "trip" it will send a trip signals.



7 WIRINGS CONNECTION

HGM8100N series controller's back as following:

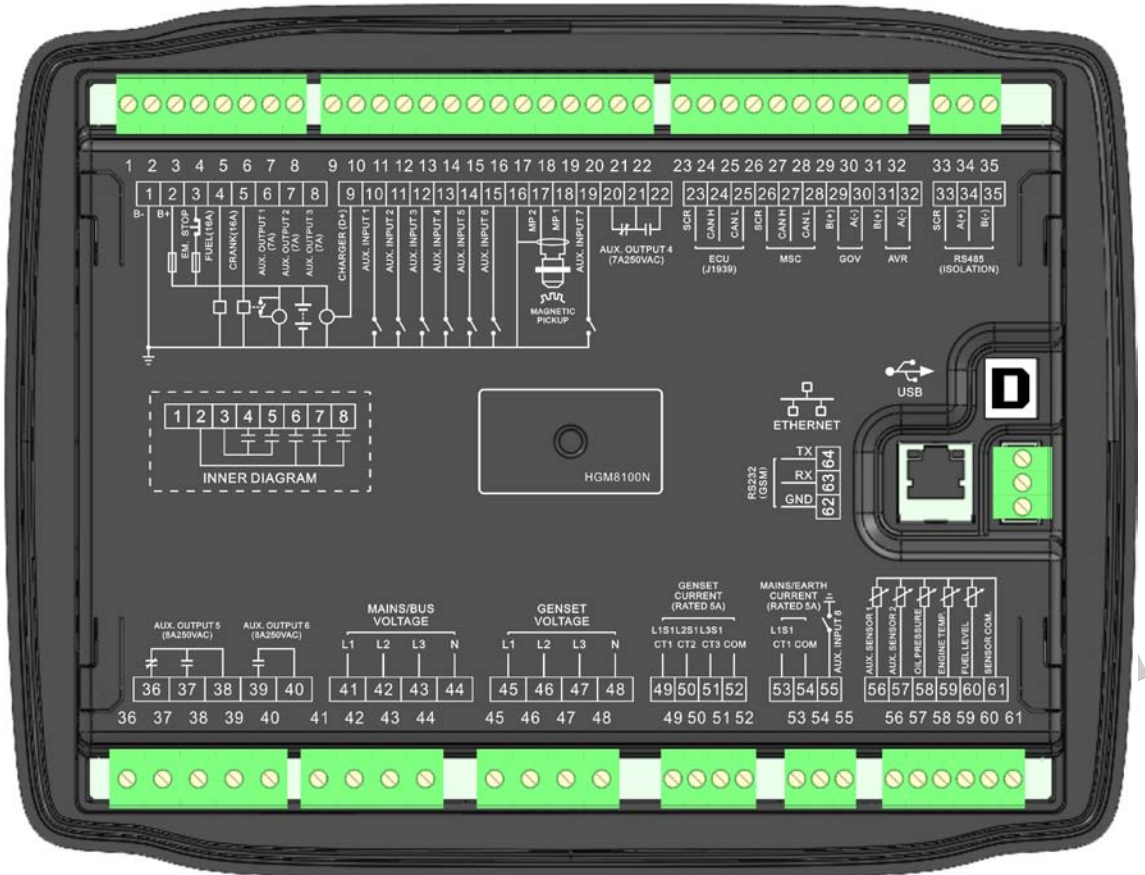

Graph1 HGM8100N Back Panel

Table 12 Terminal Wiring Connection

No.	Function	Cable Size	Remarks	
1	B-	2.5mm ²	Connected with negative of starter battery	
2	B+	2.5mm ²	Connected with positive of starter battery. If wire length is over 30m, better to double wires in parallel. Max. 20A fuse is recommended.	
3	Emergency stop	2.5mm ²	Connected with B+ via emergency stop button	
4	Fuel relay output	1.5mm ²	B+ is supplied by 3 terminal, rated 16A	
5	Start relay output	1.5mm ²	B+ is supplied by 3 terminal, rated 16A	Connected to starter coil
6	Aux. Output 1	1.5mm ²	B+ is supplied by 2 terminal, rated 7A	Details see Table 14
7	Aux. Output 2	1.5mm ²	B+ is supplied by 2 terminal, rated 7A	
8	Aux. Output 3	1.5mm ²	B+ is supplied by 2 terminal, rated 7A	



No.	Function	Cable Size	Remarks	
9	Charger(D+)	1.0mm ²	Connected with charger starter's D+ (WL) terminals. Being hang up If there is no this terminal.	
10	Aux. Input 1	1.0mm ²	Ground connected is active (B-)	Details see Table 15
11	Aux. Input 2	1.0mm ²	Ground connected is active (B-)	
12	Aux. Input 3	1.0mm ²	Ground connected is active (B-)	
13	Aux. Input 4	1.0mm ²	Ground connected is active (B-)	
14	Aux. Input 5	1.0mm ²	Ground connected is active (B-)	
15	Aux. Input 6	1.0mm ²	Ground connected is active (B-)	
16	Magnetic Pickup	0.5mm ²	Connected with Speed sensor, shielding line is recommended. (B-) has already connected with speed sensor 2	
17	MP 2			
18	MP 1			
19	Aux. Input 7	1.0mm ²	Ground connected is active (B-)	Details see Table 15
20	Aux. Output 4	1.5mm ²	Normally close output, rated 7A	Details see Table 14
21			Public points of relay	
22			Normally close output, rated 7A	
23	ECU CAN	/	Impedance-120Ω shielding wire is recommended, its single-end earthed.(HGM8110V, HGM8120V、HGM8110L and HGM8120L without this terminal)	
24	ECU CAN H	0.5mm ²		
25	ECU CAN L	0.5mm ²		
26-32	RESERVE	/	Empty terminal	
33	RS485	/	Impedance-120Ω shielding wire is recommended, its single-end earthed.	
34	RS485A(+)	0.5mm ²		
35	RS485B(-)	0.5mm ²		
36	Aux. Output 5	2.5mm ²	Normally close output, rated 8A	Details see Table 14
37		2.5mm ²	Normally close output, rated 8A	
38		2.5mm ²	Public points of relay	
39	Aux. Output 6	2.5mm ²	Normally close output, rated 8A	
40		2.5mm ²	Public points of relay	
41	Mains Voltage L1	1.0mm ²	Connected to A-phase of mains (2A fuse is recommended) (HGM8110N without)	
42	Mains Voltage L2	1.0mm ²	Connected to B-phase of mains (2A fuse is recommended) (HGM8110N without)	



No.	Function	Cable Size	Remarks	
43	Mains Voltage L3	1.0mm ²	Connected to C-phase of mains (2A fuse is recommended) (HGM8110N without)	
44	Mains Voltage N	1.0mm ²	Connected to N-wire of mains (HGM8110N without)	
45	Genset Voltage L1	1.0mm ²	Connected to A-phase of gen-set (2A fuse is recommended)	
46	Genset Voltage L2	1.0mm ²	Connected to B-phase of gen-set (2A fuse is recommended)	
47	Genset Voltage L3	1.0mm ²	Connected to C-phase of gen-set (2A fuse is recommended)	
48	Genset Voltage N	1.0mm ²	Connected to N-wire of gen-set	
49	Genset Current CT1	1.5mm ²	Outside connected to secondary coil of current transformer(rated 5A)	
50	Genset Current CT2	1.5mm ²	Outside connected to secondary coil of current transformer(rated 5A)	
51	Genset Current CT3	1.5mm ²	Outside connected to secondary coil of current transformer(rated 5A)	
52	Genset Current COM	1.5mm ²	See following installation instruction	
53	Earth Current	1.5mm ²	Outside connected to secondary coil of current transformer(rated 5A)	
54		1.5mm ²		
55	Aux. Input 8	1.0mm ²	Ground connected is active (B-)	Details see Table 15
56	Aux. sensor 1	1.0mm ²	Connected to temperature, oil pressure or fuel level sensors	Details see Table 16
57	Aux. sensor 2	1.0mm ²		
58	Oil pressure sensor	1.0mm ²		
59	Temperature sensor	1.0mm ²		
60	Fuel level sensor	1.0mm ²	Connected to fuel level sensor	
61	Sensor COM	/	Public terminal of sensor, (B-) has already connected.	
62	RS232	0.5mm ²	Connected to GSM module.	
63	RS232 RX	0.5mm ²		
64	RS232 TX	0.5mm ²		

▲NOTE: USB ports in controller rear panel are programmable parameter ports, user can directly configure controller via PC.

▲NOTE: Ethernet ports in controller rear panel are website port, user can directly configure and monitor controller via PC.

▲NOTE: Please refer to the Module Comparison in this manual for more details.

8 SCOPES AND DEFINITIONS OF PROGRAMMABLE PARAMETERS

8.1 CONTENTS AND SCOPES OF PARAMETERS

Table 13 Parameters Contents and Scopes

No.	Items	Parameters	Defaults	Description
Mains Setting				
1	AC System	(0~3)	0	0: 3P4W; 1: 3P3W; 2: 2P3W; 3: 1P2W.
2	Rated Voltage	(30~30000)V	230	Standard for checking mains over/under voltage. It is primary voltage when using voltage transformer.
3	Rated Frequency	(10.0~75.0) Hz	50.0	Standard for checking mains over/under frequency.
4	Normal Delay	(0~3600)s	10	The delay from mains abnormal to normal.
5	Abnormal Delay	(0~3600)s	5	The delay from mains normal to abnormal.
6	Volt. Trans.(PT)	(0~1)	0	0: Disable ; 1: Enable
7	Over Voltage	(0~200)%	120	Setting value is mains rated voltage's percentage, and return value (default: over voltage: 116%; under voltage: 84%) and delay value (default: 5s) can be set.
8	Under Voltage	(0~200)%	80	
9	Over Frequency	(0~200)%	114	Setting value is mains rated voltage's percentage, and return value (default: over voltage: 110%; under voltage: 94%) and delay value (default: 5s) can be set.
10	Under Frequency	(0~200)%	90%	
11	Loss of Phase	(0~1)	1	0: Disable; 1: Enable
12	Reverse Phase	(0~1)	1	
Timer Setting				
1	Start Delay	(0~3600)s	1	Time from mains abnormal or remote start signal is active to start genset.
2	Stop Delay	(0~3600)s	1	Time from mains normal or remote start signal is deactivated to genset stop.
3	Pre-heat Delay	(0~3600)s	0	Time of pre-powering heat plug before starter is powered up.
4	Cranking Time	(3~60)s	8	Time of starter power up
5	Crank Rest Time	(3~60)s	10	The waiting time before second power up when engine start fail.
6	Safety On Delay	(0~3600)s	10	Alarms for low oil pressure, high temperature, under speed, under frequency /voltage, charge fail are inactive.
7	Start Idle Time	(0~3600)s	0	Idle running time of genset when starting.
8	Warming Up Time	(0~3600)s	10	Warming time between genset switch on and normal running.



No.	Items	Parameters	Defaults	Description
9	Cooling Time	(0~3600)s	10	Radiating time before genset stop, after it unloads.
10	Stop Idle Time	(0~3600)s	0	Idle running time when genset stop.
11	ETS Solenoid Hold	(0~3600)s	20	The time of powering up the electromagnet during stop procedure.
12	Fail to Stop Delay	(0~3600)s	0	Time between ending of genset idle delay and stopped when "ETS time" is set as 0; Time between ending of ETS hold delay and stopped when "ETS Hold output time" is not 0.
13	After Stop Time	(0~3600)s	0	Time between genset stopped and standby
Engine Setting				
1	Engine Type	(0~39)	0	Default: Conventional genset When connected to J1939 engine, choose the corresponding type.
2	Flywheel Teeth	(10~300)	118	Tooth number of the engine, for judging of crank disconnect conditions and inspecting of engine speed. See the installation instructions.
3	Rated Speed	(0~6000)r/min	1500	Offer standard to judge over/under/loading speed.
4	Loading Speed	(0~100)%	90	Setting value is percentage of rated speed. Controller detects when it is ready to load. It won't switch on when speed is under loading speed.
5	Loss of Speed Signal	(0~3600)s	5	Time from detecting speed is 0 to confirm the action.
6	Loss of Speed Action	(0~1)	0	0:Warn; 1:Shutdown
7	Over Speed Shutdown	(0~200)%	114	Setting value is percentage of rated speed and delay value (default: 2s) also can be set.
8	Under Speed Shutdown	(0~200)%	80	Setting value is percentage of rated speed and delay value (default: 3s) also can be set.
9	Over Speed Warn	(0~200)%	110	Setting value is percentage of rated speed and delay value (default: 5s) and return value (default: over speed: 108%; under speed: 90%) also can be set.
10	Under Speed Warn	(0~200)%	86	
11	Battery Rated Voltage	(0~60.0)V	24.0	Standard for detecting over/under voltage of battery.



No.	Items	Parameters	Defaults	Description
12	Battery Over Volts	(0~200)%	120	Setting value is percentage of rated voltage of battery. Delay value (default: 5s) & return value (default: over voltage: 115%; under voltage: 90%) also can be set.
13	Battery Under Volts	(0~200)%	85	
14	Charge Alt Fail	(0~60.0)V	8.0	In normal running, when charger D+(WL) voltage under this value, charge failure alarms.
15	Start Attempts	(1~10) times	3	Max. Crank times of crank attempts. When reach this number, controller will send start failure signal.
16	Crank Disconnect	(0~6)	2	See Table 17 There are 3 conditions of disconnecting starter with engine. Each condition can be used alone and simultaneously to separating the start motor and genset as soon as possible.
17	Disconnect Generator Freq	(0~200)%	24	When generator frequency higher than the set value, starter will be disconnected. See the installation instruction.
18	Disconnect Engine Speed	(0~200)%	24	When generator speed higher than the set value, starter will be disconnected. See the installation instruction.
19	Disconnect Oil Pressure	(0~1000)kPa	200	When generator oil pressure higher than the set value, starter will be disconnected. See the installation instruction.
Generator Setting				
1	AC System	(0~3)	0	0: 3P4W; 1: 3P3W; 2: 2P3W; 3: 1P2W.
2	Poles	(2~64)	4	Numbers of generator pole, used for calculating starter rotate speed when without speed sensor.
3	Rated Voltage	(30~30000)V	230	To offer standards for detecting of generator' over/under voltage and loading voltage. It is primary voltage when using voltage transformer.
4	Loading Voltage	(0~200)%	85	Setting value is percentage of generator rated voltage. Detect when controller ready to loading. If generator voltage under load voltage, won't enter into normally running.
5	Rated Frequency	(10.0~75.0) Hz	50.0	To offer standards for detecting of over/under/load frequency.
6	Loading Frequency	(0~200)%	85	Setting value is percentage of generator rated frequency. When generator



No.	Items	Parameters	Defaults	Description
				frequency under load frequency, it won't enter into normal running.
7	Volt. Trans.(PT)	(0~1)	0	0: Disable; 1:Enable
8	Over Volt. Shutdown	(0~200)%	120	Setting value is percentage of generator rated volt. Delay value (default: 3s) also can be set.
9	Under Volt. Shutdown	(0~200)%	80	
10	Over Freq. Shutdown	(0~200)%	114	Setting value is percentage of generator rated freq. Delay value (default: over frequency: 2s; under frequency: 3s) also can be set
11	Under Freq. Shutdown	(0~200)%	80	
12	Over Volt. Warn	(0~200)%	110	Setting value is percentage of generator rated volt. Delay value(default: 5s) and return value(default: over voltage:108%; under voltage: 86%) also can be set.
13	Under Volt. Warn	(0~200)%	84	
14	Over Freq. Warn	(0~200)%	110	Setting value is percentage of generator rated freq. Delay value (default: 5s) and return value (default: over frequency: 108%; under frequency: 86%) also can be set.
15	Under Freq. Warn	(0~200)%	84	
16	Loss of Phase	(0~1)	1	0: Disable 1: Enable
17	Phase Sequence Wrong	(0~1)	1	
Load Setting				
1	Current Transform	(5~6000)/5	500	The ratio of external CT
2	Rated Current	(5~6000)A	500	Generator's rated current, standard of load current.
3	Rated Power	(0~6000)kW	276	Generator's rated power, standard of load power.
4	Over Current	(0~200)%	120	Setting value is percentage of generator rated volt. Delay value also can be set as fixed time lag or inverse time lag..
5	Over Power	(0~1)	0	0: Disable 1: Enable
6	Reverse Power	(0~1)	0	0: Disable 1: Enable
7	Earth Fault	(0~1)	0	0: Disable 1: Enable
Switch Setting				
1	Transfer Time	(0~7200)s	5	Interval time from mains switch off to generator switch on; or from generator switch off to mains switch on.
2	Close Time	(0~20.0)s	5.0	Pulse width of mains/generator switch on.



No.	Items	Parameters	Defaults	Description
				When it is 0, means output constantly.
3	Open Time	(0~20.0)s	3.0	Pulse width of mains/generator switch off.
4	Check Time	(0~20.0)s	5.0	Time of detecting switch auxiliary contacts after transferred.
5	Check Fail Warn	(0~1)	0	0: Disable 1: Enable
6	Open Check	(0~1)	0	0: Disable 1: Enable
7	Immediate Mains Dropout	(0~1)	1	0: Disable 1: Enable
Module Setting				
1	Power on Mode	(0~2)	0	0: Stop mode 1: Manual mode 2: Auto mode
2	Module Address	(1~254)	1	Controller's address during remote sensing.
3	Stop Bits	(0~1)	0	0: 2 stop bits; 1: 1 stop bit
4	Language	(0~2)	0	0: Simplified Chinese 1: English 2: Others
5	Password	(0~65535)	00318	For entering advanced parameters setting.
6	Temperature Unit	(0-1)	0	0: °C 1: °F
7	Press Unit	(0-2)	0	0: kPa; 1: Psi; 2: Bar
8	Time and Date			Current time and date can be set by users.
9	Ethernet	(0-1)	1	0: Disable 1: Enable All the settings about Ethernet (IP address, subnet mask) will active after the next time power on.
GSM Setting				
1	GSM Enable	(0~1)	0	0: Disable; 1: Enable
2	Phone Number	Max.20 digits		0: Disable; 1: Enable Its national and area's cods must be added. e.g. China: 8613666666666.
Scheduling And Maintenance Setting				
1	Scheduled Run	(0~1)	0	0: Disable; 1: Enable
2	Scheduled Not Run	(0~1)	0	0: Disable; 1: Enable
3	Maintenance	(0~1)	0	0: Disable; 1: Enable
Sensor				
Temperature Sensor				
1	Curve Type	(0~15)	7	SGX See Table16.
2	Open Circuit Action	(0~2)	0	0: Warn; 1: Shutdown; 2: No action
3	High Temp. Shutdown	(0~300)°C	98	Shutdown when sensor temperature higher than this value. Detecting only after safety



No.	Items	Parameters	Defaults	Description
				delay is over. The delay value (default: 3s) also can be set.
4	High Temp. Warn	(0~300) °C	95	Warn when sensor temperature higher than this value. Detecting only after safety delay is over. The delay value (default: 5s) and return value (default: 93) also can be set.
5	Low Temp. Warn	(0~1)	0	0: Disable; 1: Enable
Oil Pressure Sensor				
1	Curve Type	(0~15)	7	SGX See Table 16.
2	Open Circuit Action	(0~2)	0	0: Warn 1: Shutdown 2: No action
3	Low Oil Pressure Shutdown	(0~1000)kPa	103	Shutdown when oil pressure lower than this value. Detecting only after safety delay is over. The delay value (default: 3s) also can be set.
4	Low Oil Pressure Warn	(0~1000)kPa	124	Warn when oil pressure higher than this value. Detecting only after safety delay is over. The delay value (default: 5s) and return value (default: 138) also can be set.
Liquid Level Sensor				
1	Curve Type	(0~15)	4	SGH See Table 16
2	Open Circuit Action	(0~2)	0	0:Warn; 1:Shutdown; 2:No action
3	Low Level Warn	(0~300)%	10	Warn when level lower than this value. It is detecting all the time. The delay value (default: 5s) and return value (default: 15%) also can be set.
Flexible Sensor 1				
1	Flexible Sensor 1 Setting	(0~1)	0	0: Disable 1: Enable; (can be set as temperature/pressure/liquid lever sensor).
Flexible Sensor 2				
1	Flexible Sensor 2 Setting	(0~1)	0	0: Disable; 1: Enable; (can be set as temperature/pressure/liquid lever sensor).
Digital Inputs				
Digital Input Port 1				
1	Contents Setting	(0~55)	28	Remote start (on load). See Table 15
2	Active Type	(0~1)	0	0: Closed to active 1: Open to active
Digital Input Port 2				
1	Contents Setting	(0~55)	26	High temperature shutdown See Table 15



No.	Items	Parameters	Defaults	Description
2	Active Type	(0~1)	0	0: Closed to active 1: Open to active
Digital Input Port 3				
1	Contents Setting	(0~55)	27	Low oil pressure shutdown See Table 15
2	Active Type	(0~1)	0	0: Closed to active 1: Open to active
Digital Input Port 4				
1	Contents Setting	(0~55)	0	User defined. See Table 15
2	Active Type	(0~1)	0	0: Closed to active 1: Open to active
3	Arming	(0~3)	2	0: From safety on 1: From starting 2: Always 3:Never
4	Active Actions	(0~4)	0	0: Warn; 1: Shutdown; 2:Trip and stop 3:Trip 4: Indication
5	Active Delay	(0~20.0)s	2.0	Time from detecting active to confirm
6	Description			LCD display detailed contents when the input is active.
Digital Input Port 5				
1	Contents Setting	(0~55)	0	User defined. See Table 15
2	Active Type	(0~1)	0	0: Closed to active 1: Open to active
3	Arming	(0~3)	2	0: From safety on 1: From starting 2: Always 3:Never
4	Active Actions	(0~4)	1	0: Warn; 1: Shutdown; 2:Trip and stop 3:Trip 4: Indication
5	Active Delay	(0~20.0)s	2.0	Time from detecting active to confirm
6	Description			LCD display detailed contents when the input is active.
Digital Input Port 6				
1	Contents Setting	(0~55)	0	User defined .See Table 15
2	Active Type	(0~1)	0	0: Closed to active 1: Open to active
3	Arming	(0~3)	2	0: From safety on 1: From starting 2: Always 3:Never
4	Active Actions	(0~4)	2	0: Warn; 1: Shutdown; 2:Trip and stop 3:Trip 4: Indication
5	Active Delay	(0~20.0)s	2.0	Time from detecting active to confirm
6	Description			LCD display detailed contents when the input is active.
Digital Input Port 7				
1	Contents Setting	(0~55)	5	Lamp test. See Table 15



No.	Items	Parameters	Defaults	Description
2	Active Type	(0~1)	0	0: Closed to active 1: Open to active
Digital Input Port 8				
1	Contents Setting	(0~55)	0	User defined .See Table 15
2	Active Type	(0~1)	0	0: Closed to active 1: Open to active
3	Arming	(0~3)	2	0: From safety on 1: From starting 2: Always 3:Never
4	Active Actions	(0~4)	0	0: Warn; 1: Shutdown; 2:Trip and stop 3:Trip 4: Indication
5	Active Delay	(0~20.0)s	2.0	Time from detecting active to confirm
6	Description			LCD display detailed contents when the input is active.
Relay Outputs				
Relay Output Port 1				
1	Contents Setting	(0~299)	1	User defined period output (default output is in preheating) See Table 14
2	Active Type	(0~1)	0	0:Normally open; 1:Normally close
Relay Output Port 2				
1	Contents Setting	(0~299)	35	Idle control output. See Table 14
2	Active Type	(0~1)	0	0:Normally open; 1:Normally close
Relay Output Port 3				
1	Contents Setting	(0~299)	29	Generator closed output. See Table 14
2	Active Type	(0~1)	0	0:Normally open; 1:Normally close
Relay Output Port 4				
1	Contents Setting	(0~299)	31	Mains closed output. See Table14
2	Active Type	(0~1)	0	0:Normally open; 1:Normally close
Relay Output Port 5				
1	Contents Setting	(0~299)	38	ETS solenoid hold. See Table 14
2	Active Type	(0~1)	0	0:Normally open; 1:Normally close
Relay Output Port 6				
1	Contents Setting	(0~299)	48	Common alarm. See Table 14
2	Active Type	(0~1)	0	0:Normally open; 1:Normally close

8.2 ENABLE DEFINITION OF PROGRAMMABLE OUTPUT PORTS

8.2.1. ENABLE DEFINITION OF PROGRAMMABLE OUTPUT PORTS FORM

Table 14 Enable Programmable Output Ports

No.	Type	Description
0	Not Used	
1	Custom Period 1	Details of function description please see the following.
2	Custom Period 2	
3	Custom Period 3	
4	Custom Period 4	
5	Custom Period 5	
6	Custom Period 6	
7	Custom Combined 1	
8	Custom Combined 2	
9	Custom Combined 3	
10	Custom Combined 4	
11	Custom Combined 5	
12	Custom Combined 6	
13	Reserved	
14	Reserved	
15	Reserved	
16	Reserved	
17	Air Flap Control	Action when over speed shutdown and emergence stop. It also can close the air in flow .
18	Audible Alarm	Action when warning, shutdown, trips. Can be connected annunciator externally. When "alarm mute" configurable input port is active, it can remove the alarm.
19	Louver Control	Action in genset starting and disconnect when genset stopped completely.
20	Fuel Pump Control	It is controlled by fuel pump of level sensor's limited threshold.
21	Heater Control	It is controlled by heating of temperature sensor's setting bound.
22	Cooler Control	It is controlled by cooler of temperature sensor's setting bound.
23	Pre-Supply Fuel Output	Action when start and running safety period.
24	Generator Excite	Output in start period. If there is no generator frequency during hi-speed running, output for 2 seconds again.
25	Pre-Lubricate	Actions in period of pre-heating to safety run.
26	Remote Control Output	This port is controlled by communication (PC).
27	GSM Power Supply	Power for GSM module (GSM module is reset when GSM communication failed).
28	Reserved	
29	Close Gen Output	Control generator to take load.



No.	Type	Description
30	Open Output	Control generator to off load.
31	Close Mains Output	Control mains to take load.
32	Reserved	
33	Start Relay	
34	Fuel Relay	Action when genset is cranking and disconnect when stopped completely.
35	Idle Control	Used for engine which has idles. Close before starting and open in warming up delay; Close during stopping idle mode and open when stop is completed.
36	Speed Raise Relay	Action in warming up delay.
37	Speed Drop Relay	Action between the period from "stop idle" to "failed to stop".
38	Energize to Stop	Used for engines with ETS electromagnet. Close when stop idle is over and open when pre-set "ETS delay" is over.
39	Speed Drop Pulse	Active 0.1s when controller enter into stop idle, used for control part of ECU dropping to idle speed.
40	ECU Stop	Used for ECU engine and control its stop.
41	ECU Power Supply	Used for ECU engine and control its power.
42	Speed Raise Pulse	Active 0.1s when controller enter into warming up delay; used for control part of ECU raising to normal speed.
43	Crank Success	Close when detects a successful start signal.
44	Generator OK	Action when generator are normal.
45	Generator Load Available	Action in period of generator ok to hi-speed cooling.
46	Mains OK	Action when mains normal.
47	Reserved	
48	Common Alarm	Action when genset common warning, common shutdown, common trips alarm.
49	Common Trip and Stop	Action when common trip and stop alarm.
50	Common Shutdown	Action when common shutdown alarm.
51	Common Trip	Action when common trips alarm.
52	Common Warning	Action in common warning alarm.
53	Reserved	
54	Battery Over Volts	Action when battery's over voltage warning alarm.
55	Battery Under Volts	Action when battery's low voltage warning alarm.
56	Charge Alternator Failure	Action when charge failure warning alarms.
57	Reserved	
58	Reserved	
59	Reserved	
60	ECU Warning	Indicate ECU sends a warning signal.
61	ECU Shutdown	Indicate ECU sends a shutdown signal.
62	ECU Communication Failure	Indicate controller not communicates with ECU.
63	Reserved	
64	Reserved	



No.	Type	Description
65	Reserved	
66	Reserved	
67	Reserved	
68	Reserved	
69	Digital Input 1 Active	Action when input port 1 is active
70	Digital Input 2 Active	Action when input port 2 is active
71	Digital Input 3 Active	Action when input port 3 is active
72	Digital Input 4 Active	Action when input port 4 is active
73	Digital Input 5 Active	Action when input port 5 is active
74	Digital Input 6 Active	Action when input port 6 is active
75	Digital Input 7 Active	Action when input port 7 is active
76	Digital Input 8 Active	Action when input port 8 is active
77-80	Reserved	
81-96	Extend Digital Input 1-16 Active	Action when extend switch input port is active.
99	Emergency Stop	Action when emergency stop alarm.
100	Fail To Start	Action when failed start alarm.
101	Fail To Stop	Action when failed stop alarm.
102	Under Speed Warning	Action when under speed alarm.
103	Under Speed Shutdown	Action when under speed shuts down.
104	Over Speed Warning	Action when over speed warn.
105	Over Speed Shutdown	Action when over speed shutdown alarm.
106	Reserved	
107	Reserved	
108	Reserved	
109	Gen over freq Warning	Action when generator over frequency warning.
110	Gen over freq Shutdown	Action when generator over frequency shutdown alarm.
111	Gen Over Volt Warn	Action when generator over voltage warning.
112	Gen Over Volt Shut	Action when generator over voltage shutdown.
113	Gen Under Freq Warning	Action when generator low frequency warning.
114	Gen Under Freq. Shut	Action when generator low frequency shutdown.
115	Gen Under Volt. Warning	Action when generator low voltage warning.
116	Gen Under Volt. Shut	Action when generator low voltage shutdown.
117	Gen Loss of Phase	Action when generator loss phase.
118	Gen Phase Sequence Wrong	Action when generator reverse phase.
119	Reserved	
120	Over Power Alarm	Action when controller detects generator have over power.
121	Reserved	
122	Generator Reverse Power	Action when controller detects generator have reverse power.
123	Over Current Alarm	Action when over current.
124	Reserved	
125	Mains Inactive	
126	Mains Over Freq	



No.	Type	Description
127	Mains Over Volt	
128	Mains Under Freq	
129	Mains Under Volt	
130	Mains Reverse Phase	
131	Mains Loss of Phase	
132~138	Reserved	
139	High Temp Warning	Action when hi-temperature warning.
140	Low Temp Warning	Action when low temperature warning.
141	High Temp Shutdown	Action when hi-temperature shutdown alarm.
142	Reserved	
143	Low Oil Pressure Warning	Action when low oil pressure warning.
144	Low Oil Pressure Shutdown	Action when low oil pressure shutdown.
145	Oil Pressure Sensor Open Circuit	Action when oil pressure sensor is open circuit.
146	Reserved	
147	Low Fuel Level	Action when controller has low oil level alarm.
148	Reserved	
149	Reserved	
150	Flexible Sensor 1 High Warn	
151	Flexible Sensor 1 Low Warn	
152	Flexible Sensor 1 High Shut	
153	Flexible Sensor 1 Low Shut	
154	Flexible Sensor 2 High Warn	
155	Flexible Sensor 2 Low Warn	
156	Flexible Sensor 2 High Shut	
157	Flexible Sensor 2 Low Shut	
158~161	Reserved	
162	Extend1 sensor15 High Shut	
163	Extend1 sensor15 High Alarm	
164	Extend1 sensor15 Low Shut	
165	Extend1 sensor15 Low Alarm	
166-201	Extend1 sensor16-24	
202-229	Reserved	
230	Stop Mode	Action in stop mode.
231	Manual Mode	Action in Manual mode.
232	Reserved	
233	Auto Mode	Action in Auto mode.
234	Generator On Load	
235	Mains On Load	
236~239	Reserved	
240~279	PLC Flag 1-40	Action when PLC flag is 1.
280~299	Reserved	

8.2.2. CUSTOM PERIOD OUTPUT

Defined Period output is composed by 2 parts, **period output S1** and **condition output S2**.



While **S1** and **S2** are **TRUE** synchronously, **OUTPUT**;

While **S1** or **S2** is **FALSE**, **NOT OUTPUT**.

Period output S1, can set generator's one or more period output freely, can set the delayed time and output time after enter into period.

Condition output S2; can set as any conditions in output ports.

▲NOTE: when delay time and output time both are 0 in period output **S1**, it is **TRUE** in this period.

Example,

Output period: start

Delay output time: 2s

Output time: 3s

Condition output contents: output port 1 is active

Close when condition output active/inactive: close when active (disconnect when inactive);

Output port 1 active, after enter "starts time" and delay 2s, this defined period output is outputting, after 3s, stop outputting;

Output port 1 inactive, defined output period is not outputting.

8.2.3. CUSTOM COMBINED OUTPUT

Defined combination output is composed by 3 parts, condition output **S1** or **S2** and condition output **S3**.

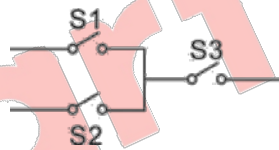

S1 or **S2** is **TRUE**, while **S3** is **TRUE**, Defined combination output is outputting;

S1 and **S2** are **FALSE**, or **S3** is **FALSE**, Defined combination output is not outputting.

▲NOTE: **S1, S2, S3** can be set as any contents except for "defined combination output" in the output setting.

▲NOTE: 3 parts of defined combination output (**S1, S2, S3**) couldn't include or recursively include themselves.

Example,

Contents of probably condition output **S1**: output port 1 is active;

Close when probably condition output **S1** is active /inactive: close when active (disconnect when inactive);

Contents of probably condition output **S2**, output port 2 is active;

Close when probably condition output **S2** is active /inactive: close when active (disconnect when inactive);

Contents of probably condition output **S3**: output port 3 is active;

Close when probably condition output **S3** is active /inactive: close when active (disconnect when inactive);

When input port 1 active or input port 2 active, if input port 3 is active, Defined combination output is outputting; If input port 3 inactive, Defined combination output is not outputting;

When input port 1 inactive and input port 2 inactive, whatever input port 3 is active or not, Defined combination output is not outputting.

8.3 DEFINED CONTENTS OF CONFIGURABLE INPUT PORTS

All active when connect to grand (b-)

Table 15 Enable Programmable Inputs

No.	Type	Description
0	Users Defined	Including following functions, Indication: indicate only, not warning or shutdown. Warning: warn only, not shutdown. Shutdown: alarm and shutdown immediately Trip and stop: alarm, generator unloads and shutdown after hi-speed cooling Trip: alarm, generator unloads but not shutdown. Never: input inactive. Always: input is active all the time. From crank: detecting as soon as start. From safety on: detecting after safety on run delay.
1	Reserved	
2	Alarm Mute	Can prohibit "Audible Alarm" output when input is active.
3	Reset Alarm	Can reset shutdown alarm and trip alarm when input is active.
4	60Hz Active	Use for CANBUS engine and it is 60Hz when input is active.
5	Lamp Test	All LED indicators are illuminating when input is active.
6	Panel Lock	All buttons in panel is inactive except direction buttons and there is  in the right of first row in LCD when input is active.
7	Reserved	
8	Idle Speed Active	Under voltage/frequency/speed protection is inactive.
9	Auto Stop Inhibit	In Auto mode, during generator normal running, when input is active, inhibit generator shutdown automatically.
10	Auto Start Inhibit	In Auto mode, inhibit generator start automatically when input is active.
11	Scheduled Run Inhibit	In Auto mode, inhibit scheduled run genset when input is active.
12	Reserved	
13	Gen Closed Auxiliary	Connect generator loading switch's Aux. Point.
14	Gen Load Inhibit	Prohibit genset switch on when input is active.
15	Mains Closed Auxiliary	Connect mains loading switch's Aux. Point.
16	Mains Load Inhibit	Prohibit mains switch on when input is active.
17	Auto Mode Lock	When input is active, controller enters into Auto mode; mode selection buttons are inactive.
18	Auto Mode Inhibit	When input is active, controller won't work under Auto mode. Auto mode key and simulate auto key input does not work.
19	Reserved	



20	Reserved	
21	Alarm Stop Inhibit	All shutdown alarms are prohibited except emergency stop.(Means battle mode or override mode)
22	Aux Instrument Mode	All outputs are prohibited in this mode.
23	Reserved	
24	Reset Maintenance Alarm	Controller will set maintenance time and date as default when input is active.
25	Reserved	
26	High Temperature Shutdown	Connected sensor digital input.
27	Low Oil Pressure Shutdown	Connected sensor digital input.
28	Remote Start On Load	In Auto mode, when input active, genset can be started automatically and take load after genset normal running; when input inactive, genset will stop automatically.
29	Remote Start Off Load	In Auto mode, when input is active, genset can be started automatically and NOT take load after genset normal running; when input is inactive, genset will stop automatically.
30	Manual Start Auxiliary	In Manual mode, when input active, genset will start automatically; when input inactive, genset will stop automatically
31	Reserved	
32	Reserved	
33	Simulate Stop Button	An external button can be connected and pressed as simulate panel.
34	Simulate Manual Button	
35	Reserved	
36	Simulate Auto Button	An external button can be connected and pressed as simulate panel.
37	Simulate Start Button	
38	Simulate Generator Load Button	This is simulate G-close key when HGM9610 controller is applied.
39	Simulate Mains Load Button	This is simulate M-open key when HGM9610 controller is applied.
40	Reserved	
41	Reserved	
42	Reserved	
43	Reserved	
44	Reserved	
45	Aux Mains OK	In Auto mode, mains are normal when input is active.
46	Aux Mains Fail	In Auto mode, mains are abnormal when input is active.
47	Alternative Config1	Users can set different parameters to make it easy to select current configuration via input port.
48	Alternative Config2	
49	Alternative Config3	
50-55	Reserved	

8.4 SELECTION OF SENSORS

Table 16 Sensors Selection

No.		Description	Remark
1	Temperature Sensor	0 Not used 1 Custom Res Curve 2 Custom 4-20mA curve 3 VDO 4 CURTIS 5 VOLVO-EC 6 DATCON 7 SGX 8 SGD 9 SGH 10 PT100 11 SUSUKI 12 PRO 13~15 Reserved	Defined resistance's range is 0~6KΩ, default is SGX sensor.
2	Pressure Sensor	0 Not used 1 Custom Res Curve 2 Custom 4-20mA curve 3 VDO 10Bar 4 CURTIS 5 VOLVO-EC 6 DATCON 10Bar 7 SGX 8 SGD 9 SGH 10 VDO 5Bar 11 DATCON 5Bar 12 DATCON 7Bar 13 SUSUKI 14 PRO 15 Reserved	Defined resistance's range is 0~6KΩ, default is SGX sensor.
3	Oil Level Sensor	0 Not used 1 Custom Res Curve 2 Custom 4-20mA curve 3 SGD 4 SGH 5~15 Reserved	Defined resistance's range is 0~6KΩ, default is SGH sensor.

▲NOTE: User should make special declare when order controller if your genset equip with sensor of 4~20mA.

8.5 CONDITIONS OF CRANK DISCONNECT SELECTION

Table 17 Crank Disconnect Conditions Selection

No.	Setting description
0	Gen frequency
1	Speed sensor
2	Speed sensor + Gen frequency
3	Oil pressure
4	Oil pressure + Gen frequency
5	Oil pressure + Speed sensor
6	Oil pressure + Speed sensor + Gen frequency

▲NOTE:

1. There are 3 conditions to make starter disconnected with engine, that is, speed sensor, generator frequency and engine oil pressure. They all can be used separately. We recommend that engine oil pressure should be using with speed sensor and generator frequency together, in order to make the starter motor is separated with engine immediately and can check crank disconnect exactly.
2. Speed sensor is the magnetic equipment which be installed in starter for detecting flywheel teeth.
3. When set as speed sensor, must ensure that the number of flywheel teeth is as same as setting, otherwise, "over speed shutdown" or "under speed shutdown" may be caused.
4. If genset without speed sensor, please don't select corresponding items, otherwise, "start fail" or "loss speed signal" maybe caused.
5. If genset without oil pressure sensor, please don't select corresponding items.
6. If not select generator frequency in crank disconnect setting, controller will not collect and display the relative power quantity (can be used in water pump set); if not select speed sensor in crank disconnect setting, the rotating speed displayed in controller is calculated by generator frequency and number of poles.

9 PARAMETERS SETTING

In **HGM8110N** controller, there are no items of mains in setting and also no mains items in configurable ports of input/output.

▲CAUTION: Please change the controller parameters when generator is in standby mode only (e. g. Crank disconnect conditions selection, configurable input, configurable output, various delay), otherwise, shutdown and other abnormal conditions may happen.

▲NOTE:

- 1) Maximum set value must over minimum set value in case that the condition of too high as well as too low will happen.
- 2) When setting the warning alarm, please set the correct return value; otherwise, maybe there is abnormal alarm. When setting the maximum value, the return value must less than set value; when setting the minimum value, the return value must over set value.
- 3) Please set the generator frequency value as low as possible when cranking, in order to make the starter be separated quickly as soon as crank disconnect.
- 4) Configurable input could not be set as same items; otherwise, there are abnormal functions. However, the configurable output can be set as same items.



10 SENSORS SETTING

1. When reselect sensors, the sensor curve will be transferred into the standard value. For example, if temperature sensor is SGX (120°C resistor type), its sensor curve is SGX (120°C resistor type); if select the SGD (120°C resistor type), the temperature sensor curve is SGD curve.
2. When there is difference between standard sensor curves and using sensor, user can adjust it in “curve type”.
3. When input the sensor curve, X value (resistor) must be input from small to large, otherwise, mistake occurs.
4. If select sensor type as “None”, sensor curve is not working.
5. If corresponding sensor has alarm switch only, user must set this sensor as “None”, otherwise, maybe there is shutdown or warning.
6. The headmost or backmost values in the vertical coordinates can be set as same as below,

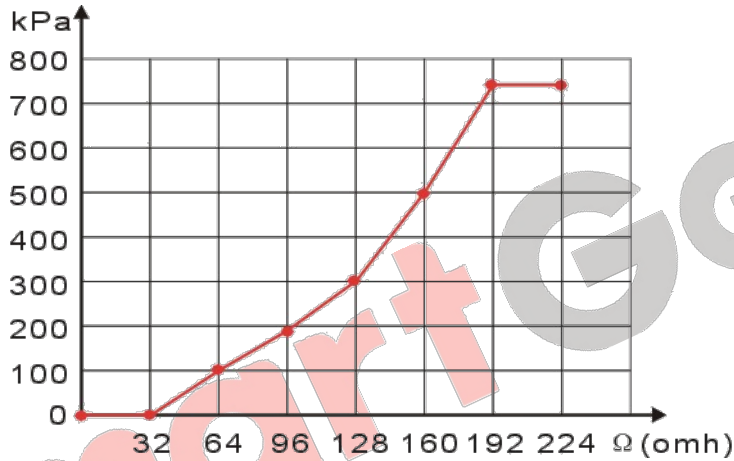

Graph 2 Sensor Curve Setting

Table 18 Normal Pressure Unit Conversion Form

	N/m ² pa	kgf/cm ²	bar	psi
1Pa	1	1.02x10 ⁻⁵	1x10 ⁻⁵	1.45x10 ⁻⁴
1kgf/cm ²	9.8x10 ⁴	1	0.98	14.2
1bar	1x10 ⁵	1.02	1	14.5
1psi	6.89x10 ³	7.03x10 ⁻²	6.89x10 ⁻²	1

11 COMMISSIONING

Please make the under procedures checking before commissioning,

- 1) Ensure all the connections are correct and wires diameter is suitable.
- 2) Ensure that the controller DC power has fuse, controller's positive and negative connected to start battery are correct.
- 3) Emergence stop must be connected with positive of start battery via scram button's normal close point and fuse.
- 4) Take proper action to prevent engine to crank disconnect (e. g. Remove the connection wire of fuel valve). If checking is OK, make the start battery power on; choose manual mode and controller will executive routine.
- 5) Set controller under manual mode, press "start" button, genset will start. After the setting times as setting, controller will send signal of Start Fail; then press "stop" to reset controller.
- 6) Recover the action of stop engine start (e. g. Connect wire of fuel valve), press start button again, genset will start. If everything goes well, genset will normal run after idle running (if idle run be set). During this time, please watch for engine's running situations and AC generator's voltage and frequency. If abnormal, stop genset running and check all wires connection according to this manual.
- 7) Select the **AUTO** mode from controller's panel, connect mains signal. After the mains normal delay, controller will transfer ATS (if fitted) into mains load. After cooling time, controller will stop genset and make it into "at rest" mode until there is abnormal of mains.
- 8) When mains is abnormal again, genset will be started automatically and into normal running, then controller send signal to making generator switch on, and control the ATS as generator load. If not like this, please check ATS' wires connection of control part according to this manual.
- 9) If there is any other question, please contact SmartGen's service.

12 TYPICAL APPLICATION

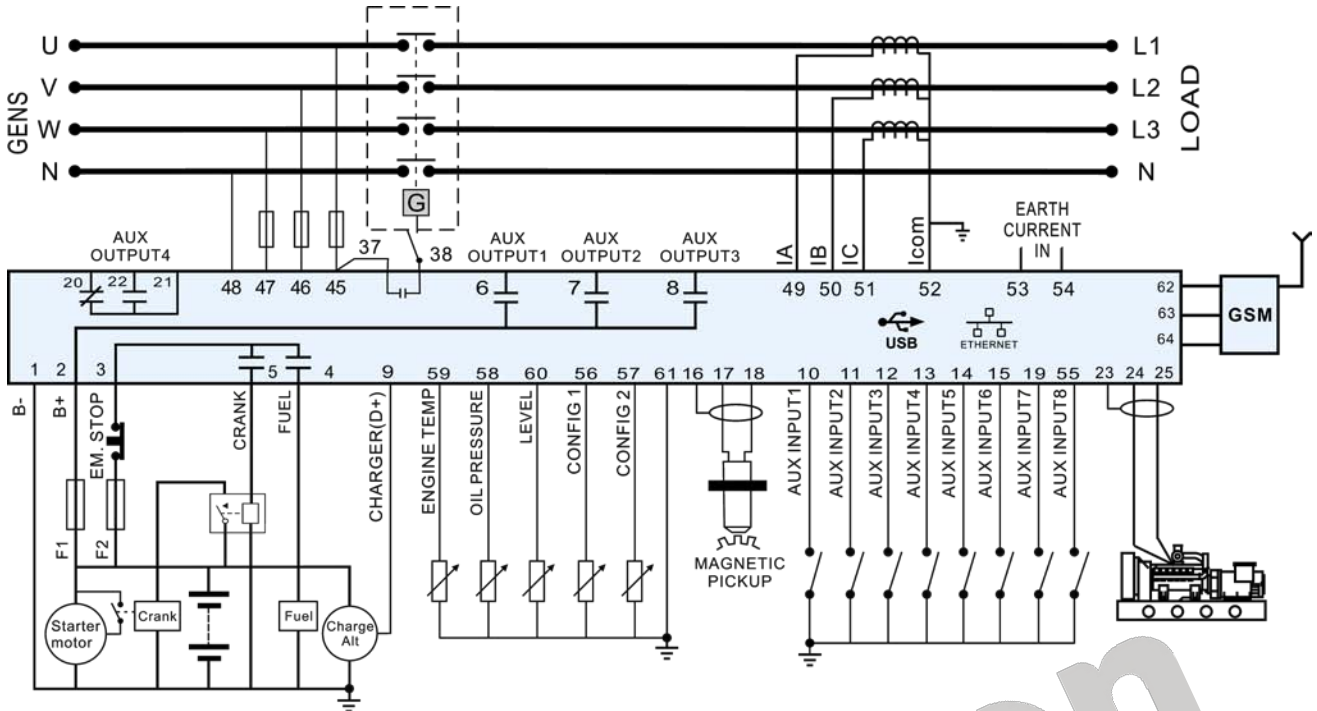

Graph 3 HGM8110N Typical Application Diagram

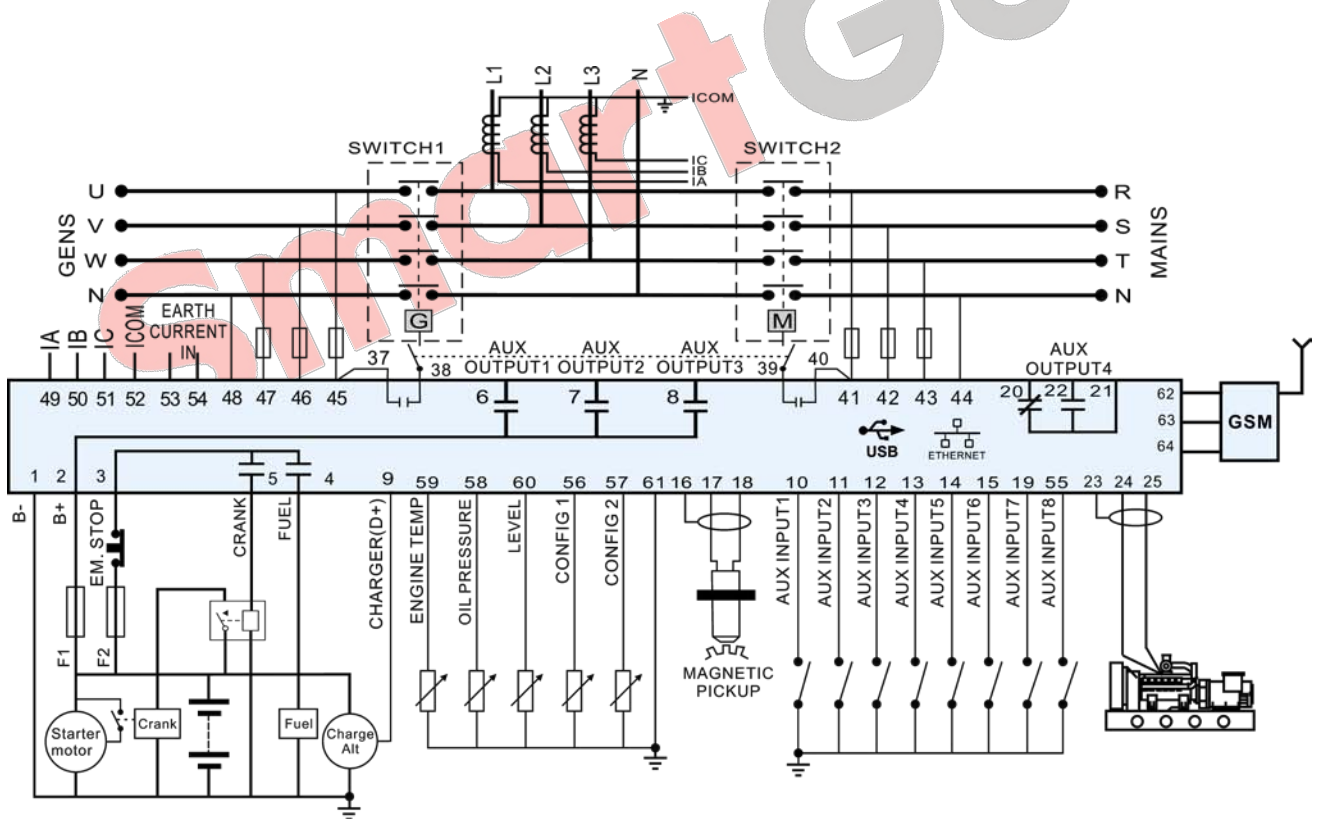

Graph 4 HGM8120N typical application diagram

NOTE: Fuse F1: min. 2A; max. 20A. Fuse F2: max. 32A. Users should select suitable fuse depend on practical application.

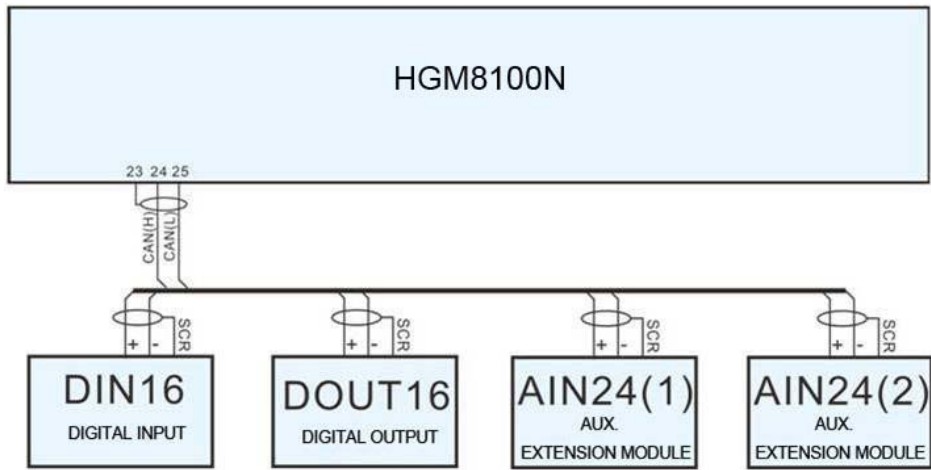

Graph 5 HGM8100N Expend Module

SmartGen

13 INSTALLATION

13.1 OVERALL DIMENSION

Controller is panel built-in design; it is fixed by clips when installed. The controller's overall dimensions and cutout dimensions for panel, please refers to as following,

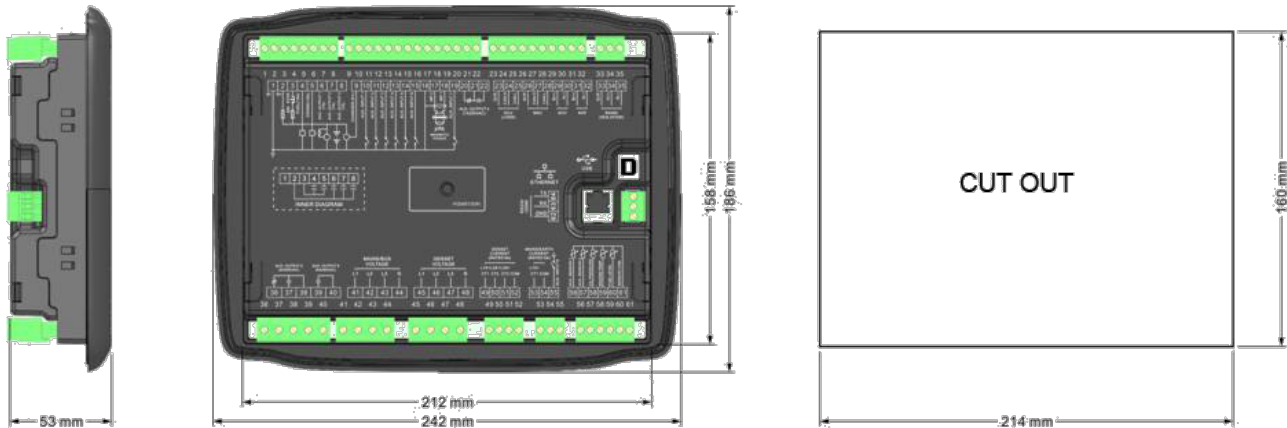

Graph 6 Overall Dimensions

13.2 BATTERY VOLTAGE INPUT

HGM8100N series controller can suit for widely range of battery voltage DC(8~35)V. Negative of battery must be connected with the engine shell. Diameter of wire that connects from power supply to battery must be over 2.5mm^2 . If floating charge configured, please firstly connect output wires of charger to battery's positive and negative directly, then, connect wires from battery's positive and negative to controller's positive and negative input ports in order to prevent charge disturbing the controller's normal working.

13.3 SPEED SENSOR INPUT

Speed sensor is the magnetic equipment which be installed in starter and for detecting flywheel teeth. Its connection wires to controller should apply for 2 cores shielding line. The shielding layer should connect to No. 16 terminal in controller while another side is hanging in air. The else two signal wires are connected to No.17 and No.18 terminals in controller. The output voltage of speed sensor should be within AC(1~24)V (effective value) during the full speed. AC12V is recommended (in rated speed). When install the speed sensor, let the sensor is spun to contacting flywheel first, then, port out 1/3 lap, and lock the nuts of sensor at last.

13.4 OUTPUT AND EXPAND RELAYS

CAUTION: All outputs of controller are relay contact output type. If need to expand the relays, please add freewheel diode to both ends of expand relay's coils (when coils of relay has DC current) or, increase resistance-capacitance return circuit (when coils of relay has AC current), in order to prevent disturbance to controller or others equipment.

13.5 AC INPUT

Current input of controller must be connected to outside current transformer. And the current

transformer's secondary side current must be 5A. At the same time, the phases of current transformer and input voltage must correct. Otherwise, the current of collecting and active power maybe not correct.

▲NOTE: ICOM port must be connected to negative pole of battery.



WARNING! When there is load current, transformer's secondary side prohibit open circuit.

13.6 WITHSTAND VOLTAGE TEST

▲CAUTION! When controller had been installed in control panel, if need the high voltage test, please disconnect controller's all terminal connections, in order to prevent high voltage into controller and damage it.

SmartGen

14 GSM SHORT MESSAGE ALARM AND REMOTE CONTROL

14.1 GSM SHORT MESSAGE ALARM

When controller detects alarm, it will send short message to phone automatically.

▲NOTE: All alarms about shutdown, trip and stop and trip will be sent to the pre-set phone. Warnings are sent to the phone according to the pre-set.

14.2 GSM SHORT MESSAGE REMOTE CONTROL

Users send order message to GSM module, then controller will make actions according to this SMS order and pass back corresponding operations information. Controllers only execute the orders by pre-set.

Table 19 SMS Orders List

No.	SMS Orders	Pass back Information	Description
1	SMS GENSET	GENSET ALARM	When genset is stopping alarm
		SYSTEM IN STOP MODE GENSET AT REST	At rest status in stop mode
		SYSTEM IN MANUAL MODE GENSET AT REST	At rest status in manual mode
		SYSTEM IN AUTO MODE GENSET AT REST	At rest status in Auto mode
		SYSTEM IN STOP MODE GENSET IS RUNNING	Running status in stop mode
		SYSTEM IN MANUAL MODE GENSET IS RUNNING	Running status in manual mode
		SYSTEM IN AUTO MODE GENSET AT RUNNING	Running status in stop mode
2	SMS START	GENSET ALARM	Generator is shutdown alarm or trip alarm
		STOP MODE NOT START	Cannot start in stop mode
		SMS START OK	Start in manual mode
		AUTO MODE NOT START	Cannot start in auto mode
3	SMS STOP MODE	SMS STOP OK	Set as stop mode
4	SMS MANUAL MODE	SMS MANUAL MODE OK	Set as manual mode
5	SMS AUTO MODE	SMS AUTO MODE OK	Set as auto mode
6	SMS DETAIL	Pass back information can be set via controller software.	Gets details information of genset.
7	SMS INHIBIT START	INHIBIT START OK	Set as inhibit start
8	SMS PERMIT START	PERMIT START OK	Remove inhibit boot

▲NOTE: Its national and area's cods must be added. e.g. China: 861366666666.

▲NOTE: When sending orders, users need to follow SMS orders in above form and all the letters must be capital.

▲NOTE: Pass back information from SMS DETAIL including: working mode, mains voltage, generator voltage, load current, mains frequency, generator frequency, active power, apparent power, power factor, battery voltage, D+ voltage, water temperature, oil pressure, oil level, engine speed, total running time, genset status, and alarm status.

15 CONNECTIONS OF CONTROLLER WITH J1939 ENGINE

15.1 CUMMINS ISB/ISBE

Table 20 Connector B

Terminals of controller	Connector B	Remark
Fuel relay output	39	
Start relay output	-	Connect with starter coil directly.
Auxiliary output 1	Expand 30A relay, battery voltage of 01,07,12,13 is supplied by relay.	ECU power Set Auxiliary output 1 as "ECU power".

Table 21 9Pins Connector

Terminals of controller	9 pins connector	Remark
CAN GND	SAE J1939 shield	CAN communication shielding line(connect with ECU terminal only).
CAN(H)	SAE J1939 signal	Impedance 120Ω connecting line is recommended.
CAN(L)	SAE J1939 return	Impedance 120Ω connecting line is recommended.

Engine type: Cummins ISB

15.2 CUMMINS QSL9

Suitable for CM850 engine control mode

Table 22 50Pins Connector

Terminals of controller	50 pins connector	Remark
Fuel relay output	39	
Start relay output	-	Connect to starter coil directly.

Table 23 9Pins Connector

Terminals of controller	9 pins connector	Remark
CAN GND	SAE J1939 shield-E	CAN communication shielding line(connect with ECU terminal only).
CAN(H)	SAE J1939 signal-C	Using impedance 120Ω connecting line.
CAN(L)	SAE J1939 return-D	Using impedance 120Ω connecting line.

Engine type: Cummins-CM850

15.3 CUMMINS QSM11(import)

It is suitable for CM570 engine control module. Engine type is QSM11 G1, QSM11 G2.

Table 24 C1Pin Connector

Terminals of controller	C1 connector	Remark
Fuel relay output	5&8	Outside expand relay, when fuel output, making port 5 and port 8 of C1 be connected.
Start relay output	-	Connect to starter coil directly.

Table 25 3Pins Data Link Connector

Terminals of controller	3 pins data link connector	Remark
CAN GND	C	CAN communication shielding line(connect with ECU terminal only).
CAN(H)	A	Using impedance 120Ω connecting line.
CAN(L)	B	Using impedance 120Ω connecting line.

Engine type: Cummins ISB

15.4 CUMMINS QSX15-CM570

It is suitable for CM570 engine control module. Engine type is QSX15.

Table 26 50Pins Connector

Terminals of controller	50 pins connector	Remark
Fuel relay output	38	Oil spout switch
Start relay output	-	Connect to starter coil directly.

Table 27 9Pins Connector

Terminals of controller	9 pins connector	Remark
CAN GND	SAE J1939 shield-E	CAN communication shielding line (connect with ECU terminal only).
CAN(H)	SAE J1939 signal-C	Using impedance 120Ω connecting line.
CAN(L)	SAE J1939 return-D	Using impedance 120Ω connecting line.

Engine type: Cummins QSX15-CM570

15.5 CUMMINS GCS-MODBUS

It is suitable for GCS engine control module. RS485-MODBUS used to read information of engine. Engine types are QSX15, QST30, QSK23 / 45/60/78 and so on.

Table 28 D-SUB Connector 06

Terminals of controller	D-SUB connector 06	Remark
Fuel relay output	5&8	Outside expand relay, when fuel output, making port 05 and 08 of the connector 06 be connected.
Start relay output	-	Connect to starter coil directly.

Table 29 D-SUB Connector 06

Terminals of controller	D-SUB connector 06	Remark
RS485 GND	20	CAN communication shielding line(connect with ECU terminal only).
RS485+	21	Using impedance 120Ω connecting line.
RS485-	18	Using impedance 120Ω connecting line.

Engine type: Cummins QSK-MODBUS, Cummins QST-MODBUS, Cummins QSX-MODBUS

15.6 CUMMINS QSM11

Table 30 Engine OEM Connector

Terminals of controller	OEM connector of engine	Remark
Fuel relay output	38	
Start relay output	-	Connect with starter coil directly
CAN GND	-	CAN communication shielding line(connect with controller's this terminal only).
CAN(H)	46	Using impedance 120Ω connecting line.
CAN(L)	37	Using impedance 120Ω connecting line.

Engine type: common J1939
15.7 CUMMINS QSZ13

Table 31 Engine OEM Connector

Terminals of controller	OEM connector of engine	Remark
Fuel relay output	45	
Start relay output	-	Connect to starter coil directly
Auxiliary output 1	16&41	Setting to idle speed control, normally open output. Making 16 connect to 41 during high-speed running of controller via external expansion relay.
Auxiliary output 2	19&41	Setting to pulse raise speed control, normally open output. Making 19 connect with 41 for 0.1s during high-speed warming of controller via external expansion relay.
CAN GND	-	CAN communication shielding line(connect with controller's this terminal only).
CAN(H)	1	Using impedance 120Ω connecting line.
CAN(L)	21	Using impedance 120Ω connecting line.

Engine type: Common J1939
15.8 DETROIT DIESEL DDEC III / IV

Table 32 Engine CAN Connector

Terminals of controller	CAN port of engine	Remark
Fuel relay output	Expand 30A relay, battery voltage of ECU is supplied by relay.	
Start relay output	-	Connect to starter coil directly.
CAN GND	-	CAN communication shielding line(connect with controller's terminal only).
CAN(H)	CAN(H)	Using impedance 120Ω connecting line.
CAN(L)	CAN(L)	Using impedance 120Ω connecting line.

Engine type: Common J1939

15.9 DEUTZ EMR2

Table 33 F Connector

Terminals of controller	F connector	Remark
Fuel relay output	Expand 30A relay, battery voltage of 14 is supplied by relay. Fuse is 16A.	
Start relay output	-	Connect to starter coil directly.
-	1	Connect to battery negative pole.
CAN GND	-	CAN communication shielding line(connect with controller's terminal only).
CAN(H)	12	Impedance 120Ω connecting line is recommended.
CAN(L)	13	Impedance 120Ω connecting line is recommended.

Engine type: VolvoEDC4
15.10 JOHN DEERE

Table 34 21Pins Connector

Terminals of controller	21 pins connector	Remark
Fuel relay output	G,J	
Start relay output	D	
CAN GND	-	CAN communication shielding line(connect with controller's terminal only).
CAN(H)	V	Using impedance 120Ω connecting line.
CAN(L)	U	Using impedance 120Ω connecting line.

Engine type: John Deere
15.11 MTU MDEC

Suitable for MTU engines, 2000 series, 4000series

Table 35 X1 Pin Connector

Terminals of controller	X1 connector	Remark
Fuel relay output	BE1	
Start relay output	BE9	
CAN GND	E	CAN communication shielding line(connect with one terminal only).
CAN(H)	G	Using impedance 120Ω connecting line.
CAN(L)	F	Using impedance 120Ω connecting line.

Engine type: MTU-MDEC-303
15.12 MTU ADEC(SMART MODULE)

It is suitable for MTU engine with ADEC (ECU8) and SMART module.

Table 36 ADEC(X1 Connector)

Terminals of controller	ADEC (X1port)	Remark
Fuel relay output	X1 10	X1 Terminal 9 Connected to negative of battery
Start relay output	X1 34	X1 Terminal 33 Connected to negative of battery

Table 37 ADEC(X4 Connector)

Terminals of controller	SMART (X4 port)	Remark
CAN GND	X4 3	CAN communication shielding line(connect to controller's this terminal only).
CAN(H)	X4 1	Using impedance 120Ω connecting line.
CAN(L)	X4 2	Using impedance 120Ω connecting line.

Engine type: MTU-ADEC
15.13 MTU ADEC (SAM MODULE)

It is suitable for MTU engine with ADEC (ECU7) and SAM module.

Table 38 ADEC(X1 Connector)

Terminals of controller	ADEC (X1port)	Remark
Fuel relay output	X1 43	X1 Terminal 28 Connected to negative of battery.
Start relay output	X1 37	X1 Terminal 22 Connected to negative of battery.

Table 39 SAM(X23 Connector)

Terminals of controller	SAM (X23 port)	Remark
CAN GND	X23 3	CAN communication shielding line(connect with controller's this terminal only).
CAN(H)	X23 2	Using impedance 120Ω connecting line.
CAN(L)	X23 1	Using impedance 120Ω connecting line.

Engine type: Common J1939
15.14 PERKINS

It is suitable for ADEM3/ ADEM4 engine control module. Engine type is 2306, 2506, 1106, and 2806.

Table 40 Connector

Terminals of controller	Connector	Remark
Fuel relay output	1,10,15,33,34	
Start relay output	-	Connect to starter coil directly.
CAN GND	-	CAN communication shielding line(connect with controller's terminal only).
CAN(H)	31	Using impedance 120Ω connecting line.
CAN(L)	32	Using impedance 120Ω connecting line.

Engine type: Perkins
15.15 SCANIA

It is suitable for S6 engine control module. Engine type is DC9, DC12, and DC16.

Table 41 B1 Connector

Terminals of controller	B1 connector	Remark
Fuel relay output	3	
Start relay output	-	Connect to starter coil directly.
CAN GND	-	CAN communication shielding line(connect with controller's terminal only).
CAN(H)	9	Using impedance 120Ω connecting line.
CAN(L)	10	Using impedance 120Ω connecting line.

Engine type: Scania

15.16 VOLVO EDC3

Suitable engine control mode is TAD1240, TAD1241, and TAD1242.

Table 42 "Stand alone" Connector

Terminals of controller	"Stand alone" connector	Remark
Fuel relay output	H	
Start relay output	E	
Auxiliary output 1	P	ECU power Configurable output 1, "ECU power" .

Table 43 "Data bus" Connector

Terminals of controller	"Data bus" connector	Remark
CAN GND	-	CAN communication shielding line(connect with controller's terminal only).
CAN(H)	1	Using impedance 120Ω connecting line.
CAN(L)	2	Using impedance 120Ω connecting line.

Engine type: Volvo

▲NOTE: When this engine type is selected, preheating time should be set to at least 3 seconds.

15.17 VOLVO EDC4

Suitable engine types: TD520, TAD520 (optional), TD720, TAD720 (optional), TAD721, TAD722, and TAD732.

Table 44 Connector

Terminals of controller	Connector	Remark
Fuel relay output	Expanded 30A relay, and relay offers battery voltage for terminal14. Fuse is 16A	
Start relay output	-	Connect to starter coil directly.
	1	Connected to negative of battery.
CAN GND	-	CAN communication shielding line(connect with controller's terminal only).
CAN(H)	12	Using impedance 120Ω connecting line.
CAN(L)	13	Using impedance 120Ω connecting line.

Engine type: VolvoEDC4

15.18 VOLVO-EMS2

Volvo Engine types are TAD734, TAD940, TAD941, TAD1640, TAD1641, and TAD1642.

Table 45 Engine CAN Connector

Terminals of controller	Engine's CAN port	Remark
Auxiliary output 1	6	ECU stop Configurable output 1 "ECU stop".
Auxiliary output 2	5	ECU power Configurable output 2 "ECU power".
	3	Negative power
	4	Positive power
CAN GND	-	CAN communication shielding line(connect with controller's terminal only).
CAN(H)	1(Hi)	Using impedance 120Ω connecting line.
CAN(L)	2(Lo)	Using impedance 120Ω connecting line.

Engine type: Volvo-EMS2

▲NOTE: When this engine type is selected, preheating time should be set to at least 3 seconds.

15.19 YUCHAI

It is suitable for BOSCH common rail pump engine.

Table 46 Engine 42 Pin Connector

Terminals of controller	Engine 42 pins port	Remark
Fuel relay output	1.40	Connect to engine ignition lock.
Start relay output	-	Connect to starter coil directly.
CAN GND	-	CAN communication shielding line(connect with controller's this terminal only).
CAN(H)	1.35	Using impedance 120Ω connecting line.
CAN(L)	1.34	Using impedance 120Ω connecting line.

Table 47 Engine 2 Pin Connector

Battery	Engine 2 pins	Remark
Battery negative	1	Wire diameter 2.5mm ²
Battery positive	2	Wire diameter 2.5mm ²

Engine type: BOSCH

15.20 WEICHAI

It is suitable for Weichai BOSCH common rail pump engine.

Table 48 Engine Connector

Terminals of controller	Engine port	Remark
Fuel relay output	1.40	Connect to engine ignition lock.
Start relay output	1.61	
CAN GND	-	CAN communication shielding line (connect to the controller at this end only).
CAN(H)	1.35	Using impedance 120Ω connecting line.
CAN(L)	1.34	Using impedance 120Ω connecting line.

Engine type: GTSC1

▲NOTE: If there is any question of connection between controller and ECU communication, please feel free to contact SmartGen's service.

16 ETHERNET INTERFACE

16.1 ETHERNET INTERFACE INTRODUCTION

ETHERNET port, used for controller monitoring, has two connection modes: network client mode and web server mode.

NOTE: After changing controller network parameters (e.g. IP address, sub network mask etc.) new settings will take effect only after the controller is restarted.

16.2 NETWORK CLIENT MODE

When the controller is used as network client, it can be monitored via network port using TCP ModBus protocol.

The procedure is the following:

- 1) Set IP address and sub network of the controller. The IP address must in the same network segment as the IP address of monitoring equipment (e.g. PC) e.g.: if monitoring equipment IP address is 192.168.0.16, controller IP can be 192.168.0.18, sub network mask 255.255.255.0
- 2) Connect the controller. It can be connected to the monitoring equipment directly using network cable or via switchboard.
- 3) The communication between the controller and monitoring equipment is carried out using TCP ModBus protocol.

NOTE: In this connection mode controller parameters can be set. SmartGen provides testing software for this connection mode. Communication protocol can be obtained from the SmartGen service.

16.3 CONTROLLER AND NETWORK CABLE CONNECTION

Table 49 Controller Internet Access

No.	Name	Description
1	TX+	Tranceive Data+
2	TX-	Tranceive Data-
3	RX+	Receive Data+
4	NC	Not connected
5	NC	Not connected
6	RX-	Receive Data-
7	NC	Not connected
8	NC	Not connected

- 1) Controller connect with PC with a line of cable
For this connection crossover cable must be used.
Crossover cable: EIA/TIA 568A standard on one end and EIA/TIA 568B on the other end.

NOTE: If PC network port has Auto MDI/MDIX function, parallel cable can also be used.

- 2) Controller and PC connection via switchboard (or router).
Parallel lines must be used.
Parallel cable: EIA/TIA 568A standard on both ends or EIA/TIA 568B standard on both ends.

NOTE: If switchboard (or router) network port has Auto MDI/MDIX function, crossover cable can also be used.

17 FAULT FINDING

Table 50 Fault and Solutions

Symptoms	Possible Solutions
Controller no response with power.	Check starting batteries; Check controller connection wirings; Check DC fuse.
Genset shutdown	Check the water/cylinder temperature is too high or not; Check the genset AC voltage; Check DC fuse.
Controller emergency stop	Check emergence stop button is correct or not; Check whether the starting battery positive be connected with the emergency stop input; Check whether the circuit is open.
Low oil pressure alarm after crank disconnect	Check the oil pressure sensor and its connections.
High water temp. alarm after crank disconnect	Check the temperature sensor and its connections.
Shutdown Alarm in running	Check related switch and its connections according to the information on LCD; Check programmable inputs.
Crank not disconnect	Check fuel oil circuit and its connections; Check starting batteries; Check speed sensor and its connections; Refer to engine manual.
Starter no response	Check starter connections; Check starting batteries.
Genset running while ATS not transfer	Check ATS; Check the connections between ATS and controllers.
RS485 communication is abnormal	Check connections; Check setting of COM port is correct or not; Check RS485's connections of A and B is reverse connect or not; Check RS485 transfer model whether damage or not; Check communication port of PC whether damage.
ECU communication failed	Check connections of CAN high and low polarity; Check if correctly connected of 120Ω resistor; Check if type of engine correct; Check if connections from controller to engine and setting of outputs correct.
ECU warning or stop	Get information from LCD of alarm page; If there is detailed alarm, check engine according to description. If not, please refer to engine manual according to SPN alarm code.