

# SmartGen

MAKING CONTROL SMARTER

## HEM4100

### ENGINE CONTROLLER

### USER MANUAL



郑州众智科技股份有限公司  
SMARTGEN(ZHENGZHOU)TECHNOLOGY CO.,LTD.

**SmartGen**众智 Chinese trademark

**SmartGen** English trademark

**SmartGen** – make your generator *smart*

**SmartGen Technology Co., Ltd.**

**No.28 Jinsuo Road, Zhengzhou, Henan Province, China**

**Tel:** +86-371-67988888/67981888/67992951

+86-371-67981000(overseas)

**Fax:** +86-371-67992952

**Email:** [sales@smartgen.cn](mailto:sales@smartgen.cn)

**Web:** [www.smartgen.com.cn](http://www.smartgen.com.cn)

[www.smartgen.cn](http://www.smartgen.cn)

All rights reserved. No part of this publication may be reproduced in any material form (including photocopying or storing in any medium by electronic means or other) without the written permission of the copyright holder.

Applications for the copyright holder's written permission to reproduce any part of this publication should be addressed to Smartgen Technology at the address above.



Any reference to trademarked product names used within this publication is owned by their respective companies.

SmartGen Technology reserves the right to change the contents of this document without prior notice.

**Table 1 – Software Version**

Date	Version	Note
2018-08-01	1.0	Original release.
2021-01-25	1.1	1.Modify "CAN H" sign of typical application; 2.Add the new function description of the slave machine.
2022-06-28	1.2	Update the Logo of SmartGen.

**Table 2 – Notation Clarification**

Sign	Instruction
 <b>NOTE</b>	Highlights an essential element of a procedure to ensure correctness.
 <b>CAUTION!</b>	Indicates a procedure or practice, which, if not strictly observed, could result in damage or destruction of equipment.
 <b>WARNING!</b>	Indicates error operation may cause death, serious injury and significant property damage.

SmartGen

## CONTENTS

1	OVERVIEW.....	6
2	PERFORMANCE AND CHARACTERISTICS.....	6
3	SPECIFICATION .....	8
4	OPERATION.....	9
4.1	KEY FUNCTIONS DESCRIPTION .....	9
4.2	CONTROLLER PANEL.....	10
4.3	AUTOMATIC START/STOP OPERATION .....	10
4.3.1	AUTOMATIC START SEQUENCE .....	10
4.3.2	AUTOMACTIC STOP SEQUENCE.....	11
4.4	MANUAL START/STOP OPERATION.....	11
4.4.1	MANUAL START OPERATION.....	11
4.4.2	MANUAL STOP OPERATION.....	11
4.5	FUEL PRE-SUPPLY OUTPUT START OPERATION .....	12
4.6	IDLE MODE.....	12
4.7	IDLE/HIGH SPEED MODE.....	12
4.8	EMERGENCY START .....	13
4.9	ENGINE SPEED REGULATION PROCEDURE .....	13
5	PUMP UNIT (WITH SUCTION PUMP) APPLICATION OPERATIONS .....	14
5.1	D-DRIVEN PUMP START/STOP OPERATION.....	14
5.2	E-DRIVEN PUMP START/STOP OPERATION .....	14
6	PROTECTION .....	15
6.1	WARNINGS .....	15
6.2	SHUTDOWN ALARMS .....	16
7	WIRINGS CONNECTION .....	18
8	SCOPES AND DEFINITIONS OF PROGRAMMABLE PARAMETERS.....	20
8.1	SCOPES AND DEFINITIONS OF PARAMETERS .....	20
8.2	DEFINED CONTENTS OF PROGRAMMABLE OUTPUT PORTS 1~6.....	31
8.2.1	DEFINED CONTENTS OF PROGRAMMABLE OUTPUT PORTS 1~6.....	31
8.2.2	CUSTOM PERIOD OUTPUT .....	35
8.2.3	CUSTOM COMBINED OUTPUT .....	35
8.3	DEFINED CONTENTS OF PROGRAMMABLE INPUT PORTS .....	37
8.4	SELECTION OF SENSORS.....	39
8.5	CONDITIONS OF CRANK DISCONNECT SELECTION .....	40
8.6	MAINTENANCE SETTING .....	40

9	PARAMETERS SETTING.....	40
10	SENSORS SETTING .....	43
11	COMMISSIONING .....	44
12	TYPICAL APPLICATION .....	45
13	INSTALLATION .....	47
13.1	FIXING CLIPS.....	47
13.2	OVERALL DIMENSION AND CUTOUT.....	47
14	CONNECTIONS OF CONTROLLER WITH J1939 ENGINE.....	47
14.1	CUMMINS ISB/ISBE .....	48
14.2	CUMMINS QSL9 .....	48
14.3	CUMMINS QSM11 (IMPORT) .....	49
14.4	CUMMINS QSX15-CM570 .....	49
14.5	CUMMINS GCS-MOVBUS .....	50
14.6	CUMMINS QSM11.....	50
14.7	CUMMINS QSZ13.....	51
14.8	DETROIT DIESEL DDEC III/IV .....	51
14.9	DEUTZ EMR2 .....	52
14.10	JOHN DEERE .....	52
14.11	MTU MDEC.....	52
14.12	MTU ADEC (SMART MODULE).....	52
14.13	MTU ADEC (SAM MODULE).....	53
14.14	PERKINS .....	54
14.15	SCANIA.....	54
14.16	VOLVO EDC3 .....	54
14.17	VOLVO EDC4 .....	55
14.18	VOLVO-EMS2 .....	56
14.19	YUCHAI.....	56
14.20	WEICHAI .....	57
15	FAULT FINDING .....	58
16	PACKING LIST.....	59

## 1 OVERVIEW

**HEM4100 ENGINE CONTROLLER** is used for controlling engine to realize engine auto start/stop, data measurement, alarm protection and “three remotes” (remote control, remote measuring and remote communication) functions. It fits with speed regulation function, not only with relay adjust speed output but also with CANBUS (SAE J1939) interface, which can control various kinds of J1939 or conventional engines.

**HEM4100 ENGINE CONTROLLER** adopts large liquid crystal display (LCD) and selectable Chinese and English interface with easy and reliable operation. Users can read engine working parameters from the LCD directly.

**HEM4100 ENGINE CONTROLLER** uses 32-bit ARM micro-processor technology with precision parameters measuring, fixed value adjustment, time setting and threshold adjusting and etc. The majority of parameters can be set using front panel and all the parameters can be set and monitored by using PC via USB port or RS485 port. With compact structure, simple connections and high reliability, it can be widely used in a number of automatic engine control system, which including water pump system, beacon system, air compressor, engineering machinery system and so on.

## 2 PERFORMANCE AND CHARACTERISTICS

Key characteristics are as below,

- 132x64 LCD with backlight, multilingual interface (including English and Chinese languages) and easy operation interface;
- Improved LCD wear-resistance and scratch resistance due to hard screen acrylic;
- Silicon panel and pushbuttons for better operation in high and low temperature environment;
- RS485 communication port enabling remote control, remote measuring, remote communication via ModBus protocol;
- Equipped with CANBUS port and can communicate with J1939 engine. Not only can you monitoring frequently-used data (such as water temperature, oil pressure, speed, fuel consumption and so on) of ECU machine, but also control start, stop, raising speed and dropping speed via CANBUS port;
- 6-way analog sensors, 3-way fixed resistor type sensor, and 3-way flexible sensors, which can be configured as resistor/current/voltage type sensors;
- Multiple temperature, pressure and level sensor curves can be used and user-defined directly;
- Precisely collect various kinds of engine parameters and with comprehensive protection functions, such as engine high water temperature/low oil pressure, over speed and under speed protection functions;
- Speed regulation function, which can control engine raise/drop speed manually;
- With Idle/high speed switchover function;

- All outputs are relay outputs;
- Parameter setting: parameters can be modified and stored in internal FLASH memory and cannot be lost even in case of power outage;
- Multiple crank disconnect conditions (engine speed and oil pressure) are optional;
- Engine speed can be obtained by speed sensor or W/L of charging generator;
- Widely power supply range DC (8~35)V, suitable for different starting battery voltage environment;
- Event log, real-time clock, scheduled start & stop engine (can be set as start engine once a day/week/month whether);
- With heater, cooler and fuel pump control function;
- With maintenance function. Actions (warning or shutdown) can be set when maintenance time due;
- All parameters used digital adjustment, instead of conventional analog modulation with normal potentiometer, with high reliability and stability;
- Waterproof level of front panel IP65 due to rubber seal installed between the controller enclosure and panel fascia;
- Metal fixing clips enable perfect performance in high temperature environment;
- Modular design, flame retardant ABS plastic enclosure, pluggable connection terminals and embedded installation way; compact structure with easy mounting.

### 3 SPECIFICATION

**Table 3 – Technical Parameters**









Items	Contents
Operating Voltage	DC8.0V to DC35.0V, Continuous Power Supply.
Power Consumption	<3W (standby: ≤2W)
Speed Sensor Voltage	1.0V to 24.0V (RMS)
Speed Sensor Frequency	10,000 Hz (max.)
Charging Generator W/L	Voltage (1.0-24)V(RMS) Frequency (50-1000)Hz
Starting Relay Output	5A DC28V
Programmable Relay Output 1	5A DC28V
Programmable Relay Output 2-6	1A DC28V
Analog Sensor	3-way fixed resistor type sensors (temperature, flexible sensor 1, flexible sensor 2); 3-way sensors can be configured as resistor/current/voltage type sensors (oil pressure, flexible sensor 3, flexible sensor 4)
Case Dimension	135mm x 110mm x 44mm
Panel Cutout	116mm x 90mm
Working Conditions	Temperature: (-25~+70)°C; Humidity: (20~93)%RH
Storage Condition	Temperature: (-25~+70)°C
Protection Level	IP65 Front panel
Net Weight	0.35kg



## 4 OPERATION

### 4.1 KEY FUNCTIONS DESCRIPTION

**Table 4 – Keys Description**

Icons	Keys	Description
	Stop/Reset	<ol style="list-style-type: none"> <li>1. Stop running engine in Auto/Manual mode;</li> <li>2. Reset alarms in stop mode;</li> <li>3. Lamp test (pressing at least 3 seconds);</li> <li>4. Press this again in stop process can stop engine immediately;</li> </ol>
	Auto	Press this key and controller goes to <b>Auto</b> mode;
	Manual	Press this key and controller goes to <b>Manual</b> mode;
	Speed	If speed adjusting enabled, press this key to enter into adjust speed page to raise/drop engine speed;
	Start	Start engine in Manual mode;
	Up/Increase	<ol style="list-style-type: none"> <li>1. Screen scroll;</li> <li>2. Up cursor and increase value in setting menu;</li> </ol>
	Down/Decrease	<ol style="list-style-type: none"> <li>1. Screen scroll;</li> <li>2. Down cursor and decrease value in setting menu;</li> </ol>
	Set/Confirm	<ol style="list-style-type: none"> <li>1. Entering into parameter setting page after pressing this key in main screen;</li> <li>2. Confirm information in setting page.</li> </ol>

## 4.2 CONTROLLER PANEL



**Fig.1 – Front Panel Drawing**

**NOTE:** Parts of indicators description:

**Warning indicator:** Warning alarms occur: slowly flash; Shutdown alarms occur: fast flash; no alarms occur: extinguished;

**Status indicator:** It is illuminated when engine is normal; flashing when engine is in stop delay;

**Auto mode indicator:** It is illuminated when in auto mode; flashing when in start delay.

## 4.3 AUTOMATIC START/STOP OPERATION

### 4.3.1 AUTOMATIC START SEQUENCE

- Press , indicator beside it illuminated, which means engine is in auto start mode;
- When the remote start signal is active, "Start Delay" timer is initiated, and auto mode indicator flashes at the same time;
- When start delay is over, auto mode indicator changed from flashing to illuminating, and preheat relay energizes (if configured), "Preheat Delay XX s" information will be displayed on the LCD;
- After the above delay, starting relay starts output after pre-set fuel time before crank is over (default as 1s). If the engine fails to fire during this cranking attempt then the fuel relay and starting relay are disengaged for the pre-set rest period; "Crank Rest Time" begins and wait for the next crank attempt;
- If the engine fails to fire within the set crank attempts, controller will issue crank failure shutdown and corresponding information will be displayed on the LCD;



- f) In case of successful crank attempt, the "Safety On Delay" timer is activated, low oil pressure, high temperature, under speed and charging failure alarms are inactive. As soon as this delay is over, "Start Idle" delay is initiated (if configured);
- g) During "Start Idle" delay, under speed alarms are inhibited. When this delay is over, "High-speed Warming Up" delay is initiated (if configured);
- h) After the high-speed warming up delay has expired, if speed is abnormal after engine enters into normal running status, the controller will initiate shutdown alarm (alarm information will be displayed on LCD).

#### 4.3.2 AUTOMATIC STOP SEQUENCE

- a) When the remote start signal is removed, and remote stop is active, then "Stop Delay" is initiated, and status indicator flashes;
- b) Once this stop delay has expired, "High-speed Cooling Delay" is then initiated. During the delay, if remote start signal is active again, controller will re-enter into running status. If this delay is expired, "Stop Idle" delay is energized;
- c) During "Stop Idle" Delay (if configured), idle relay is energized;
- d) "ETS Solenoid Hold" delay begins, ETS relay is energized while fuel relay is de-energized;
- e) "Wait for Stop Delay" begins, complete stop is detected automatically.
- f) When engine stops completely, "After Stop" delay will be initiated. Otherwise, stop failure alarm is initiated and the corresponding alarm information is displayed on LCD. (If engine stops successfully after "Stop Failure" alarm has initiated, "After Stop" delay will be initiated and the alarm will be removed)
- g) Engine is placed into its standby mode after "After Stop" delay.

#### 4.4 MANUAL START/STOP OPERATION

##### 4.4.1 MANUAL START OPERATION

- a) Manual mode is selected by pressing  and indicator beside it illuminated.
- b) Engine is started by pressing ; successful start can be detected automatically and engine accelerates to high-speed running;
- c) If high water temperature, low oil pressure, and over speed during engine running, controller can protect it to stop quickly. (please refer to 4.3.1, c)~h)).

##### 4.4.2 MANUAL STOP OPERATION

Press  can stop the running engines. (please refer to 4.3.2, b)~g)).

## 4.5 FUEL PRE-SUPPLY OUTPUT START OPERATION

When output is configured as “Fuel Pre-supply Output” after auto/manual mode start is active:

If configured fuel pre-supply time is below/equal preheat time, LCD will display “Preheat Delay XX”, and both preheat relay (if configured) and fuel pre-supply relay (time is preset) output; when preheat delay is expired, starting relay starts output after pre-set fuel time before crank is over (default as 1s); the remaining starting process is the same as auto start sequence (process please see 4.3.1, d)~h)).

If configured fuel pre-supply time is over than preheat time, fuel pre-supply relay outputs during preheat delay period. When preheat delay is expired, the remaining fuel pre-supply time is used for fuel pre-supply time, LCD will display “Fuel Pre-supply Time XX” and fuel pre-supply relay energized; when fuel pre-supply delay is expired, fuel relay starts output for 1s, and then starting relay outputs; the remaining starting process is the same as auto start sequence (process please see 4.3.1, d)~h)).

If configured output port as “Fuel Pre-supply Output”, and engine is in standby status, it is cyclic output according to the preset “Fuel Pre-supply Rest Time” and “Fuel Pre-supply Time”; if set “Fuel Pre-supply Rest Time” as 0h, fuel pre-supply output will be not energized.

## 4.6 IDLE MODE

Input port is configured as **8: Idle Mode**.

If engine is normally running and idle mode input is active, controller will enter into idle mode and engine will start idle running. Then idle control relay will be energized and drop speed relay will output.

If engine is in standby status and idle mode input is active, engine will be started in manual mode or auto mode. When “Safety On Delay” is over, engine will enter into “Start Idle Delay” (if configured), and after this delay expired, engine will start idle running. Then idle control relay energized and drop speed relay will output.

While in idle mode and engine is idle running, if idle mode input is inactive, controller will exit idle mode, and engine will enter into normal running. Both Idle control relay and drop speed relay stop outputing.

While in idle mode and engine is idle running, press  to active stop operation, and then engine enters from “Idle Running” to “Stop Idle Delay” (if configured). The remaining stop process is the same as auto stop procedure (details please see auto stop procedure 4.3.2, c)~g)).

If the speed regulation type is relay adjust speed or CAN adjust speed, the speed can be adjusted during normal running status.

## 4.7 IDLE/HIGH SPEED MODE

Input port is configured as **14: Idle/High Speed**.

If engine is normally running and idle/high speed input is active, engine will start idle running. Then idle control relay will be energized and drop speed relay will output. If speed regulation is configured as relay adjust speed or CAN adjust speed, press raise speed key, idle control relay and drop speed relay will stop output, and speed can be adjusted during idle running.



If engine is in standby status and idle/high speed input is active, engine will be started in manual mode or auto mode. When “Safety On Delay” is over, engine will enter into “Start Idle Delay” (if configured), and after this delay expired, engine will start idle running. Then idle control relay energized and drop speed relay will output. If speed regulation is configured as relay adjust speed or CAN adjust

speed, press raise speed key, idle control relay and drop seed relay will stop output, and speed can be adjusted during idle running.

If engine is in idle running, when idle/high speed input is inactive, it will exit idle running and enter into high-speed warming up status and raise speed relay outputs. When “High-speed Warming Up Delay” expired, raise speed relay stops output, and engine enters into normal running. After speed regulation type has been configured, speed can be adjusted in normal running status.

While engine is in idle running status, press  to active stop operation, and then engine enters from “Idle Running” to “Stop Idle Delay” (if configured). The remaining stop process is the same as auto stop procedure (details please see auto stop procedure 4.3.2, c)~g)).

**4.8 EMERGENCY START**

 **NOTE:** Press  and  simultaneously can force engine to start. At this moment, engine start successfully is not controlled by crank disconnect conditions. The starter disconnection is controlled by the operator. When the operator observes that the engine has started successfully, he/she releases the key, the start stops output and the controller enters into safety on delay.



**4.9 ENGINE SPEED REGULATION PROCEDURE**

When adjust speed type is configured as **1: Relay Adjust Speed**

If set as relay adjust speed, relay output ports need to be configured as “Speed Raise Output” and “Speed Drop Output”.

When adjust speed type is configured as **2: CAN Adjust Speed**

Engine type needs to be configured as corresponding adjustable ECU unit. Through changing CAN adjust speed stepping ratio, the number of revolutions corresponding to the speed increase for each key press can be modified.

Engine speed can be adjusted by pressing , and screen is as below. Engine speed can be adjusted while engine is normally running, press  to raise speed and press  to drop speed.

Then press  again to exit.

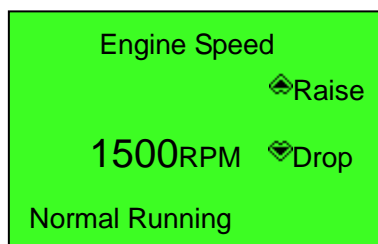

**Fig.2 – Adjust Speed Screen**

 **NOTE:** Speed can be adjusted up to 110% of rated speed.

## 5 PUMP UNIT (WITH SUCTION PUMP) APPLICATION OPERATIONS

### 5.1 D-DRIVEN PUMP START/STOP OPERATION

Set input function: D-driven Pump Started, Press. to Suction Pump.

Set output function: D-driven Pump Start, D-driven Pump Stop.

Suction pump type: D-driven.

—D-driven Pump Start:

- After auto/manual mode start is active, preheat relay outputs (if configured), and LCD displays “Preheat Delay XX”. After preheat delay finished, starting relay outputs (needs to be configured). If crank success input (needs to be configured) is invalid during “D-driven Pump Cranking Time”, starting relay stops output and it will go to “Suction Pump Crank Rest” then waiting for next crank. If the pump doesn’t crank successfully in setting cranking times, controller will issue crank failure shutdown and in the meanwhile it will show “Suction Pump Crank Failure” in LCD display.
- In any time of cranking, if D-driven pump crank success, it will enter to “Waiting Press.to” delay. When delay is expired, “Press. to Suction Pump” (needs to be configured) is invalid and controller will raise alarm and shutdown, and meanwhile “Suction Pump Fault” will be displayed on LCD.
- During the time of “waiting Pressure to”, fuel relay output set “Prestart Fuel Time” (default 1s) after “Press. to Suction Pump” (needs to be configured) is valid, and then starting relay outputs. The rest starting processes are same with auto start procedure (please refer to 4.3.1, d)~h)).

—D-driven Pump Stop: After “Safety On Delay”, “D-driven Pump Stop” outputs (needs to be configured), and it stops to output after “Energize to Stop Time”.

### 5.2 E-DRIVEN PUMP START/STOP OPERATION

Set input function: Press. to Suction Pump.

Set output function: E-driven Pump Start.

Suction pump type: E-driven.

—E-driven Pump Start: After suction pump type is set as E-driven pump and “Safety On Delay” is over, the starting relay outputs (needs to be configured).

—E-driven Pump Stop:

- While engine is between start idle and high-speed cooling time, if input is “Press. to Suction Pump” (needs to be configured) or outlet pressure is larger than the value of E-driven stop outlet pressure value, the starting relay stops output.
- While engine is in “Energize to Stop Delay”, the starting relay stops output.

**▲NOTE:** The mentioned outlet pressure of E-driven pump needs to be set in outlet pressure correlation setting, then relate to corresponding programmable sensor.

## 6 PROTECTION

### 6.1 WARNINGS

When controller detects warning alarms, it only sends warning alarms without leading engine to shut down. If alarms are removed, warnings will be cancelled automatically.

**Table 5 – Controller Warning Alarms**

No.	Type	Description
1	Over Speed	When the controller detects that the engine speed has exceeded the pre-set value, it will initiate a warning alarm.
2	Under Speed	When the controller detects that the engine speed has fallen below the pre-set value, it will initiate a warning alarm.
3	Loss of Speed Signal	When the controller detects that the engine speed is 0 and the action selects "Warning", it will initiate a warning alarm.
4	Stop Failure	After "fail to stop" delay, if engine does not stop completely, it will initiate a warning alarm.
5	Charging Failure	When the controller detects that charger voltage has fallen below the pre-set value, it will initiate a warning alarm.
6	Battery Over Voltage	When the controller detects that engine battery voltage has exceeded the pre-set value, it will initiate a warning alarm.
7	Battery Under Voltage	When the controller detects that engine battery voltage has fallen below the pre-set value, it will initiate a warning alarm.
8	ECU Warning	If a warning message is received from ECU via J1939, it will initiate a warning alarm.
9	Engine Temp. Sensor Open	When the controller detects that the temperature sensor is open circuit and the action selects "Warning", it will initiate a warning alarm.
10	Engine Temperature High	When the controller detects that engine temperature has exceeded the pre-set value, it will initiate a warning alarm.
11	Engine Temperature Low	When the controller detects that engine temperature has fallen below the pre-set value, it will initiate a warning alarm.
12	Engine OP Sensor Open	When the controller detects that the oil pressure sensor is open circuit and the action selects "Warning", it will initiate a warning alarm.
13	Engine Low Oil Pressure	When the controller detects that the oil pressure has fallen below the pre-set value, it will initiate a warning alarm.
14	Flexible Sensor 1~4 Open	When the controller detects that the flexible sensor 1~4 is open circuit and the action selects "Warning", it will initiate a warning alarm.
15	Flexible Sensor 1~4 High	When the controller detects that the sensor 1~4 value has exceeded the pre-set upper limit value, it will initiate a warning alarm.
16	Flexible Sensor 1~4 Low	When the controller detects that the sensor 1~4 value has fallen below the pre-set lower limit value, it will initiate a warning alarm.
17	Over Flow	When the controller detects that the flow value has exceeded the pre-set upper limit value, it will initiate a warning alarm.
18	Input 1~5 Warning	When action of digital inputs configured as "Warning", and input port is active, controller will initiate a warning alarm.

No.	Type	Description
19	Maintenance 1~5 Due	When count down time is 0 and the action selects "Warning", it will initiate a warning alarm.
20	End of Mandate Time	When controller reaches mandate time, and action selects "Warning", it will initiate a warning alarm.
21	Battery Under Voltage	When scheduled start, if controller detects battery voltage is lower than pre-set value, it will initiate a warning alarm. This warning cannot be cleared automatically, it can be removed by pressing "Stop" key in stop mode.

## 6.2 SHUTDOWN ALARMS

When controller detects shutdown alarm, it will send signal to open breaker and shuts down engine immediately. After engine stopped completely, alarms can be removed by pressing alarm reset key manually.

**Table 6 – Shutdown Alarms**

No.	Type	Description
1	Emergency Stop	When the controller detects emergency stop alarm signals, it will initiate a shutdown alarm.
2	Over Speed	When the controller detects that the engine speed has exceeded the pre-set value, it will initiate a shutdown alarm.
3	Under Speed	When the controller detects that the engine speed has fallen below the pre-set value, it will initiate a shutdown alarm.
4	Loss of Speed Signal	When the controller detects that the engine speed is 0 and the action select "Shutdown", it will initiate a shutdown alarm.
5	Crank Failure	If engine fails to start within preset attempts, it will initiate a shutdown alarm.
6	ECU Shutdown	If a shutdown message is received from ECU via J1939, it will initiate a shutdown alarm.
7	High Temp. IN	When one input port of controller set as "High Temp. Shutdown" and it is active, controller will initiate a shutdown alarm.
8	Low Oil Pressure IN	When one input port of controller set as "Low Oil Pressure Shutdown" and it is active, controller will initiate a shutdown alarm.
9	ECU Comm. Failure	When the controller detects that no data have been received via J1939 after engine started, it will initiate a shutdown alarm.
10	Engine Temp. Sensor Open	When the controller detects that the temperature sensor is open circuit and action selected as "Shutdown", it will initiate a shutdown alarm.
11	Engine Temp. High	When the controller detects that engine temperature has exceeded the pre-set value, it will initiate a shutdown alarm.
12	Engine OP Sensor Open	When the controller detects that the oil pressure sensor is open circuit and action selected as "Shutdown", it will initiate a shutdown alarm.
13	Engine Low Oil Pressure	When the controller detects that engine oil pressure has fallen below the pre-set value, it will initiate a shutdown alarm.
14	Flexible Sensor 1~4 Open	When the controller detects that the flexible sensor 1~4 is open circuit and the action select "Shutdown", it will initiate a shutdown alarm.



No.	Type	Description
15	Flexible Sensor 1~4 High	When the controller detects that the sensor 1~4 value has exceeded the pre-set upper limit value, it will initiate a shutdown alarm.
16	Flexible Sensor 1~4 Low	When the controller detects that the sensor 1~4 value has fallen below the pre-set lower limit value, it will initiate a shutdown alarm.
17	Suction Pump Crank Failure	If diesel driven suction pump fails to start within preset attempts, controller will initiate a shutdown alarm.
18	Suction Pump Fault	If input port "Press. to Suction Pump" signal is inactive during preset "Suction Pump Fault Delay", controller will initiate a shutdown alarm.
19	Input 1~5 Shutdown	When action of digital inputs configured as "Shutdown", and input port is active, controller will initiate a shutdown alarm.
20	Over Flow	When the controller detects that the flow value has exceeded the pre-set upper limit value, it will initiate a shutdown alarm.
21	Maintenance 1~5 Due	When count down time is 0 and the action selects "Shutdown", it will initiate a shutdown alarm.
22	End of Mandate Time	When controller reaches mandate time, and action selects "Shutdown", it will initiate a shutdown alarm.

**▲NOTE:** For the ECU warning and ECU shutdown description, if detailed alarm content has been displayed, users can check the engine according to the alarm content, otherwise, please check with engine manual based on SPN alarm codes to receive more details.

**7 WIRINGS CONNECTION**

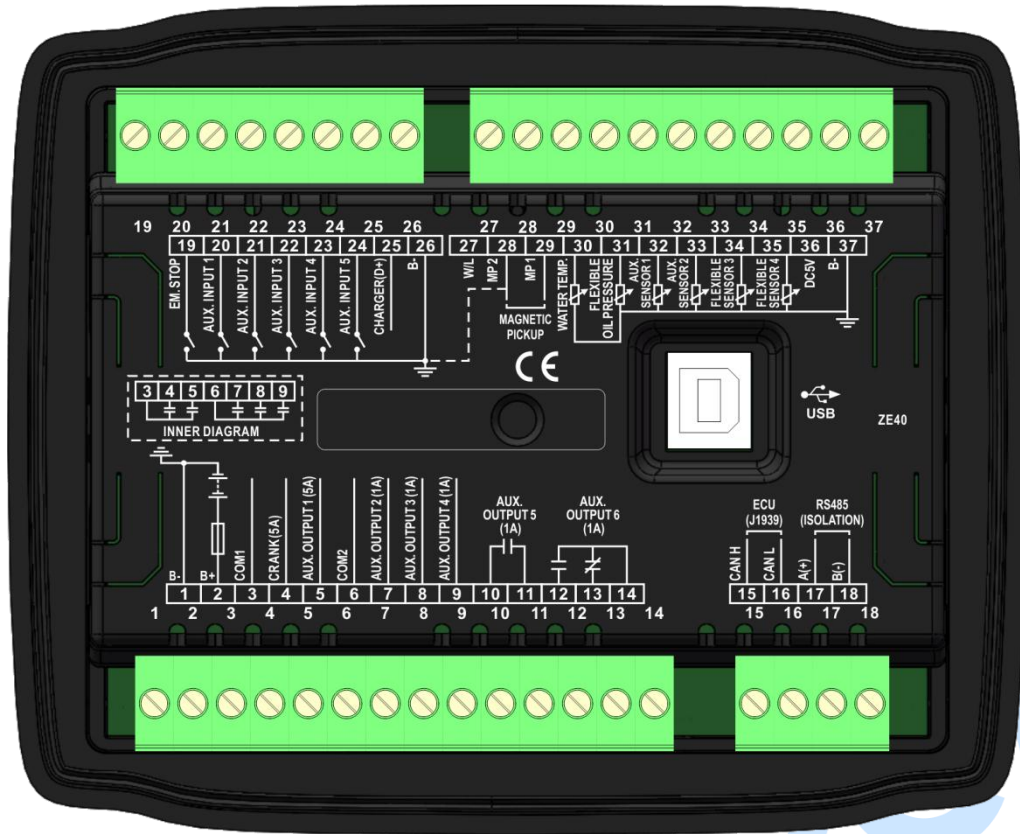

**Fig.3 – HEM4100 Rear Panel Drawing**

**Table 7 – Terminal Connection Description**

No.	Function	Cable Size	Remarks
1	B-	1.5mm <sup>2</sup>	Connected with negative of starter battery.
2	B+	1.5mm <sup>2</sup>	Connected with positive of starter battery.
3	COM1 Relay Common Port	1.5mm <sup>2</sup>	Connected with COM1 output, rated 5A DC28V.
4	Crank Relay Output	1.5mm <sup>2</sup>	
5	Aux. Output 1	1.5mm <sup>2</sup>	
6	COM2 Relay Common Port	1.0mm <sup>2</sup>	Connected with COM2 output, rated 1A DC28V.
7	Aux. Output 2	1.0mm <sup>2</sup>	
8	Aux. Output 3	1.0mm <sup>2</sup>	
9	Aux. Output 4	1.0mm <sup>2</sup>	
10	Aux. Output 5	1.0mm <sup>2</sup>	Relay normally open volt free connector, rated 1A DC28V.
11		1.0mm <sup>2</sup>	
12	Aux. Output 6	1.0mm <sup>2</sup>	Normally open, rated 1A DC28V
13		1.0mm <sup>2</sup>	Normally close, rated 1A DC28V
14		1.0mm <sup>2</sup>	Relay common port
15	ECU CAN H	0.5mm <sup>2</sup>	Impedance-120Ω shielding wire is recommended, its single-end earthed.
16	ECU CAN L	0.5mm <sup>2</sup>	
17	RS485 A(+)	0.5mm <sup>2</sup>	
18	RS485 B(-)	0.5mm <sup>2</sup>	

Details see Table 9

No.	Function	Cable Size	Remarks
19	Emergency Stop Input	0.5mm <sup>2</sup>	Controller stops engine immediately after input is active.
20	Aux. Input 1	0.5mm <sup>2</sup>	Ground connected is active (B-).
21	Aux. Input 2	0.5mm <sup>2</sup>	Ground connected is active (B-).
22	Aux. Input 3	0.5mm <sup>2</sup>	Ground connected is active (B-).
23	Aux. Input 4	0.5mm <sup>2</sup>	Ground connected is active (B-).
24	Aux. Input 5	0.5mm <sup>2</sup>	Ground connected is active (B-).
25	Charger (D+)	1.0mm <sup>2</sup>	Connect with D+(W/L) of charger, if charger without this terminal, please hang it in the air.
26	Aux. Input Common Port	0.5mm <sup>2</sup>	Internal has been connected to (B-).
27	W/L	0.5mm <sup>2</sup>	Connect with W terminal of charging generator.
28	MP2 speed sensor input, controller internal connected to B(-)	0.5mm <sup>2</sup>	Connect with engine speed sensor, shielding wire is recommended.
29	MP1 speed sensor input	0.5mm <sup>2</sup>	
30	Temp. Sensor	1.0mm <sup>2</sup>	Connect with temperature sensor (resistor type)
31	Oil Pressure Sensor	1.0mm <sup>2</sup>	Connect with pressure sensor (resistor/current/voltage type)
32	Aux. Sensor 1	1.0mm <sup>2</sup>	User-defined (resistor type)
33	Aux. Sensor 2	1.0mm <sup>2</sup>	User-defined (resistor type)
34	Aux. Sensor 3	1.0mm <sup>2</sup>	User-defined (resistor/current/voltage type)
35	Aux. Sensor 4	1.0mm <sup>2</sup>	User-defined (resistor/current/voltage type)
36	DC5V	1.0mm <sup>2</sup>	Provide power for voltage type sensor
37	Sensor COM (B-)	1.0mm <sup>2</sup>	Sensor common port, controller internal connected with B-.
	USB	/	It can communicate with PC monitoring software.

Details see Table 10

Details see Table 11

## 8 SCOPES AND DEFINITIONS OF PROGRAMMABLE PARAMETERS

### 8.1 SCOPES AND DEFINITIONS OF PARAMETERS

**Table 8 – Parameter Content and Scope**

No.	Item	Range	Default	Description
Language Setting				
1	Language	(0-3)	0	0: Simplified Chinese; 1: English; 2: Espanol; 3: Other
Override Mode				
1	Override Mode	(0-1)	0	0: Disable; 1: Enable
Module Setting				
1	Power On Mode	(0-2)	0	0: Stop Mode; 1: Manual Mode; 2: Auto Mode
2	Module Address	(1-254)	1	Controller address for remote monitoring.
3	Comm. Stop Bit	(0-1)	0	0: 2-bit Stop Bit; 1: 1-bit Stop Bit (PC software set)
4	Password	(0-9999)	0318	This password is used for entering high level parameters setting. <b>⚠ CAUTION!</b> Original password is "0318", operator can change it to prevent others from changing controller advanced configuration at will. Please memorize the new password after change, if forget, please contact with SmartGen service personnel.
5	LCD Backlight	Contrast	(0-10)	5
		Brightness	(0-5)	5
		Backlight Delay	(0-3600)min	5
6	Date and Time			Users can calibrate date and time by themselves.
Timers Setting				
1	Start Delay	(0-3600)s	1	It is time from remote start signal active to

No.	Item	Range	Default	Description
				start engine.
2	Stop Delay	(0-3600)s	1	It is time from remote start signal inactive to stop engine.
3	Preheat Delay	(0-3600)s	0	Time of pre-powering heat plug before starter is powered up.
4	Prestart Fuel Time	(0-3600)s	1	Time of fuel relay output before starter powered up.
5	Cranking Time	(3-60)s	8	Time of starter power up. (If diesel driven suction pump enabled, it is also can be cranking time of diesel driven suction pump).
6	Crank Rest Time	(3-60)s	10	The waiting time before second power up when engine starts fail. (If diesel driven suction pump enabled, it is also can be crank rest time of diesel driven suction pump).
7	Safety On Delay	(0-3600)s	10	Alarms for low oil pressure, high temperature, under speed, under frequency/voltage, charging failure are inactive during this time.
8	Start Idle Time	(0-3600)s	0	Idle running time of engine when starting.
9	Warming Up Time	(0-3600)s	10	Warming time for engine after high speed running and before taking load.
10	Cooling Time	(0-3600)s	10	Radiating time before engine stop.
11	Stop Idle Time	(0-3600)s	0	Idle running time when engine stop.
12	ETS Solenoid Hold	(0-3600)s	20	The time of powering up the electromagnet during stop procedure. (If diesel

No.	Item	Range	Default	Description
				driven suction pump enabled, it is also can be ETS solenoid hold time of diesel driven suction pump).
13	Wait Stop Time	(0-3600)s	0	Time between ending of engine idle delay and stopped completely when "ETS output time" is set as 0; Time between ending of ETS hold delay and stopped when "ETS output time" is not 0.
14	After Stop Time	(0-3600)s	0	Time between engine stopped and standby.
15	Fuel Pre-supply Rest Time	(0-12)h	2	When output is configured as "Fuel Pre-supply", it is the interval between the completion of the pre-fuel supply output and the next pre-supply output in standby status. If time is 0, fuel pre-supply is not output in standby status.
16	Fuel Pre-supply Time	(3-30)s	5	It is fuel pre-supply output time when output configured as "Fuel Pre-supply".
<b>Engine Setting</b>				
1	Engine Type	(0-39)	0	Default: Common engine (non-J1939) When connects to J1939 unit, please select the corresponding engine type.
2	Enable ECU Shutdown	(0-1)	1	0: Disable; 1: Enable
3	Source of Speed Signal	(0-1)	0	0: Speed Sensor; 1: W/L
4	W/L Ratio	(0-99.99)	9.04	
5	Flywheel Teeth	(1.0-300.0)	118.0	Tooth number of the engine, which used for judging of crank

No.	Item	Range	Default	Description	
				disconnect conditions and inspecting of engine speed. See the installation instructions.	
6	Rated Speed	(0-6000) r/min	1500	Offer standard to judge over/under/ loading speed.	
7	Crank Attempts	(1-10) Times	3	Max. crank times of crank attempts when engine failed to start. When reach this number, controller will send crank failure signal. (If diesel driven suction pump enabled, it is also can be crank attempts of diesel driven suction pump).	
8	Crank Disconnect Conditions	(0-2)	2	See table 12. There are 2 conditions of disconnecting starter with engine. Each condition can be used alone and simultaneously to separating the starting motor and engine as soon as possible.	
9	Disconnect Speed	(0-200)%	24	Setting value is the percentage of rated speed. When engine speed is higher than the set value, starter will be disconnected. See the installation instruction.	
10	Disconnect Oil Pressure	(0-1000)kPa	200	When oil pressure is higher than the set value, starter will be disconnected. See the installation instruction.	
11	Overspeed Warn	Set	(0-200.0)%	110.0	Setting value is the percentage of rated speed. Return value and delay value can be set.
		Return	(0-200.0)%	108.0	
		Delay	(0-3600)s	5	
12	Underspeed	Set	(0-200.0)%	55.0	

No.	Item		Range	Default	Description
	Warn	Return	(0-200.0)%	60.0	
		Delay	(0-3600)s	5	
13	Overspeed Shutdown	Set	(0-200.0)%	114.0	Setting value is the percentage of rated speed. Return value and delay value can be set.
		Delay	(0-3600)s	2	
14	Underspeed Shutdown	Set	(0-200.0)%	50.0	
		Delay	(0-3600)s	3	
15	Loss of Speed Signal Delay		(0-3600)s	5	It is time from detecting speed is 0 to action confirmed.
16	Loss of Speed Signal Action		(0-1)	0	0: Warning; 1: Shutdown
17	Battery Rated Voltage		(0-60.0)V	24.0	Standard for detecting over/under voltage of battery.
18	Battery Overvolt Warn	Set	(0-200)%	120	Setting value is percentage of rated voltage of battery. Delay value and return value can be set.
		Return	(0-200)%	115	
		Delay	(0-3600)s	60	
19	Battery Undervolt Warn	Set	(0-200)%	85	Setting value is percentage of rated voltage of battery. Delay value and return value can be set.
		Return	(0-200)%	90	
		Delay	(0-3600)s	60	
20	Charging Failure	Set	(0-60.0)V	8.0	In normal running, when charger D+ (W/L) voltage under this value, controller sends charging failure alarm.
		Return	(0-60.0)V	10.0	
		Delay	(0-3600)s	10	
21	Battery Undervolt Detect	Enable	(0-1)	0	When select scheduled run, it will be detected before start. If battery voltage is lower than set value, controller sends battery under voltage alarm.
		Set	(0-60.0)V	18.0	
22	Engine Idle		(0-100)%	60	Setting value is percentage of rated speed. If idle running is needed, speed will be stabilized in setting value.
23	Suction Pump Crank		(0-2)	0	0: Not Used; 1: D-driven Suction Pump; 2: E-driven Suction Pump
24	D-driven Suction Pump Fault Shutdown Delay		(0-3600)s	90	Time for waiting press to suction pump ("Waiting Press. to" input is



No.	Item	Range	Default	Description
				active).
25	Outlet Press When E-driven Suction Pump Stopped	(0-1000)kPa	100	It is pressure when "E-driven Pump Start" input stops outputting.
26	D-driven Suction Pump Crank Output Time	(0-3600)s	5	Time for D-driven suction pump crank output.
27	D-driven Suction Pump Stop Output Time	(0-3600)s	15	Time for D-driven suction pump stop output.
Analog Sensor Setting				
Temperature Sensor				
1	Curve Type	(0-15)	9	SGD. Details see Table 11.
2	Open Circuit Action	(0-2)	0	0: Warning; 1: Shutdown; 2: No Action
3	Display Unit	(0-1)	0	0: °C; 1: °F
4	High Temp. Shutdown	(0-300)°C	98	Shutdown when sensor temperature is higher than this value. Detecting only after safety delay is over. The delay value can be set.
5	High Temp. Warning	(0-300)°C	95	Warning when sensor temperature is higher than this value. Detecting only after safety delay is over. The delay value and return value can be set.
6	Low Temp. Warning	(0-300)°C	70	Warning when sensor temperature is lower than this value. Detecting only after safety delay is over. The delay value and return value can be set.
7	Heater Control	((-50)-300)°C	50	Heater control outputs when the value of external connected temperature sensor is lower than this value. The delay value and return value can be set.
8	Cooler Control	((-50)-300)°C	80	Cooler control outputs when the value of

No.	Item	Range	Default	Description
				external connected temperature sensor is higher than this value. The delay value and return value can be set.
9	Custom Curve			When custom resistor type is selected, the related curve needs to be set.
<b>Oil Pressure Sensor</b>				
1	Curve Type	(0-15)	9	SGD. Details see Table 11.
2	Open Circuit Action	(0-2)	0	0: Warning; 1: Shutdown; 2: No Action
3	Display Unit	(0-2)	0	0: kPa; 1: bar; 2: psi;
4	Low Oil Pressure Shutdown	(0-1000)kPa	103	Shutdown when oil pressure is lower than this value. Detecting only after safety delay is over. The delay value can be set.
5	Low Oil Pressure Warning	(0-1000)kPa	124	Warning when oil pressure is lower than this value. Detecting only after safety delay is over. The delay value and return value can be set.
6	Custom Curve			Setting curves (resistor/voltage/current type) according to sensors' performance.
<b>Flexible Sensor 1~4</b>				
1	Sensor Selection	(0-8)	0	0: Not Used; 1: Temperature Sensor; 2: Pressure Sensor; 3: Level Sensor; 4: Flow Sensor; 5: Pipe Pressure Sensor; 6: Inlet Pressure Sensor; 7: Water Level Sensor; 8: Outlet Pressure Sensor.
2	Curve Type			Changing based on the sensor type
3	Open Circuit Action	(0-2)	0	0: Warning; 1: Shutdown; 2: No Action

No.	Item	Range	Default	Description
4	Display Unit	(0-1)	0	0: °C; 1: °F <b>Note:</b> different sensors with different units.
5	Over Shutdown	(0-9000)	100	Shutdown when external sensor value is higher than this value. Enable alarms and delay value can be set.
6	Under Shutdown	(0-9000)	10	Shutdown when external sensor value is lower than this value. Enable alarms and delay value can be set.
7	Over Warning	(0-9000)	90	Warning when external sensor value is higher than this value. Enable alarms, return value and delay value can be set.
8	Under Warning	(0-9000)	20	Warning when external sensor value is lower than this value. Enable alarms, return value and delay value can be set.
9	Custom Curve			Setting curves (resistor/voltage/current type) according to sensors' performance.
<b>Fuel Level Sensor Correlation Setting</b>				
1	Sensor Correlate Set	(0-4)	0	0: Not Used 1: Flexible Sensor 1 2: Flexible Sensor 2 3: Flexible Sensor 3 4: Flexible Sensor 4
2	Fuel Pump Control	(0-1000)%	10	If the value of external fuel level sensor is lower than this value, fuel pump control outputs. Both return value and delay value can be set.
3	Fuel Tank Capacity Set	(0-10000)L	1000	
<b>Outlet Pressure Correlation Setting</b>				
1	Sensor Correlate Set	(0-4)	0	0: Not Used 1: Flexible Sensor 1 2: Flexible Sensor 2

No.	Item	Range	Default	Description
				3: Flexible Sensor 3 4: Flexible Sensor 4
2	Pump Head Enable	(0-1)	0	0: Disable; 1: Enable
3	Pump Flow Enable	(0-1)	0	0: Disable; 1: Enable
4	Static Pressure	(-9000-9000)kPa	0	Setting static pressure of water pump outlet port.
5	Flow Unit	(0-1)	0	0: m <sup>3</sup> /h; 1: L/s
6	Rated Flow	(0-10000)m <sup>3</sup> /h	1000	Rated working flow of engine.
7	Over Flow Warn	(0-1000)%	110	Warning if flow value is higher than this value during engine running. Enable alarms, delay value and return value can be set.
8	Over Flow Shutdown	(0-1000)%	120	Shutdown if flow value is higher than this value during engine running. Enable alarms and delay value can be set.
9	Flow Curve Set			Set the relationship between the different outlet pressures and its corresponding flows.
<b>Digital Input Ports</b>				
<b>Digital Input Port 1</b>				
1	Content Set	(0-53)	28	Remote Start Details see Table 10.
2	Active Type	(0-1)	0	0: Close; 1: Open
<b>Digital Input Port 2</b>				
1	Content Set	(0-53)	26	High Temp Shutdown Details see Table 10.
2	Active Type	(0-1)	0	0: Close; 1: Open
<b>Digital Input Port 3</b>				
1	Content Set	(0-53)	27	Low OP Shutdown Details see Table 10.
2	Active Type	(0-1)	0	0: Close; 1: Open
<b>Digital Input Port 4</b>				
1	Content Set	(0-53)	0	User Configured Details see Table 10.
2	Active Type	(0-1)	0	0: Close; 1: Open
3	Active Range	(0-3)	2	0: From Safety on; 1: From Crank;

No.	Item	Range	Default	Description
				2: Always; 3: Never
4	Active Action	(0-4)	0	0: Warning; 1: Shutdown; 2: Indication
5	Active Delay	(0-20.0)s	2.0	It is time from detecting input port is active to action confirmed.
6	Description		User-defined	
<b>Digital Input Port 5</b>				
1	Content Set	(0-53)	0	User Configured Details see Table 10.
2	Active Type	(0-1)	0	0: Close; 1: Open
3	Active Range	(0-3)	2	0: From Safety on; 1: From Crank; 2: Always; 3: Never
4	Active Action	(0-4)	1	0: Warning; 1: Shutdown; 2: Indication
5	Active Delay	(0-20.0)s	2.0	It is time from detecting input port is active to action confirmed.
6	Description		User-defined	
<b>Relay Output Ports</b>				
<b>Relay Output Port 1</b>				
1	Content Set	(0-119)	29	Fuel Relay Output Details see Table 9.
2	Active Type	(0-1)	0	0: Normally Open; 1: Normally Close
<b>Relay Output Port 2</b>				
1	Content Set	(0-119)	28	Crank Relay Output Details see Table 9.
2	Active Type	(0-1)	0	0: Normally Open; 1: Normally Close
<b>Relay Output Port 3</b>				
1	Content Set	(0-119)	30	Idle Control Details see Table 9.
2	Active Type	(0-1)	0	0: Normally Open; 1: Normally Close
<b>Relay Output Port 4</b>				
1	Content Set	(0-119)	31	Speed Raise Output Details see Table 9.
2	Active Type	(0-1)	0	0: Normally Open; 1: Normally Close

No.	Item	Range	Default	Description
<b>Relay Output Port 5</b>				
1	Content Set	(0-119)	32	Speed Drop Output Details see Table 9.
2	Active Type	(0-1)	0	0: Normally Open; 1: Normally Close
<b>Relay Output Port 6</b>				
1	Content Set	(0-119)	1	Custom Period Output Details see Table 9.
2	Active Type	(0-1)	0	0: Normally Open; 1: Normally Close
<b>Adjust Speed Setting</b>				
1	Adjust Speed Type	(0-2)	0	0: Not Used; 1: Relay Adjust Speed; 2: CAN Adjust Speed
2	CAN Adjust Speed Stepping Coefficient	(0-100)	1	CAN sends speed command to increase the number of revolutions each time.
3	Adjust Speed Relay Dead Area	(0-10.0)%	1.0	Relay auto speed control
4	Adjust Speed Relay Gain	(0-100)%	10	
5	Adjust Speed Relay Stability	(0.05-1.60)s	0.10	
6	Adjust Speed Relay Response	(0.25-4.00)	0.5	
7	Idle Adjust Speed Enable	(0-1)	0	0: Disable; 1: Enable. When it is enabled, engine is in idle running, it doesn't accelerate to high speed automatically and needs to adjust speed manually.
<b>Scheduling and Maintenance Setting</b>				
1	Scheduled Run	(0-1)	0	0: Disable; 1: Enable
2	Scheduled Not Run	(0-1)	0	0: Disable; 1: Enable
3	Maintenance 1	(0-1)	0	0: Disable; 1: Enable Maintenance time, maintenance time due action, pre-alarm A and pre-alarm B time and action, maintenance timing, and reset maintenance can be set simultaneously. After engine has been maintained, the
4	Maintenance 2	(0-1)	0	
5	Maintenance 3	(0-1)	0	
6	Maintenance 4	(0-1)	0	
7	Maintenance 5	(0-1)	0	

No.	Item	Range	Default	Description
				maintenance time due alarm can be reset by replacing the maintenance time. Details see Table 13.

**NOTE:**

- When doing parameter configuration via PC software, there is no need to input password if default password (0318) isn't change; otherwise, if default password been changed or first time to set parameters via PC, password need to be written into the password interface.
- Different digital input ports cannot be configured as the same item, otherwise, errors may occur. However, different relay output ports can be configured as the same item.
- Fuel level sensor correlation: if need to use fuel level function, one of flexible sensor 1~4 needs to be configured as fuel level sensor, meanwhile, curve type needs to correspond to sensor types. Then set the correlated sensor and select the corresponding flexible sensor. At this time, the flexible sensor is the fuel level sensor, which can realize fuel pump control and tank volume display.
- Outlet pressure correlation: if need to calculate flow and head via water pressure gauge, one of flexible sensor 1~4 needs to be configured as outlet press sensor, meanwhile, curve type needs to correspond to sensor types. Then set the correlated sensor and select the corresponding flexible sensor. At this time, flow and head can be calculated via outlet pressure gauge.
- Outlet pressure correlation also needs to be configured if E-driven suction pump needs to judge whether to stop the output according to the outlet pressure.

**8.2 DEFINED CONTENTS OF PROGRAMMABLE OUTPUT PORTS 1~6**

**8.2.1 DEFINED CONTENTS OF PROGRAMMABLE OUTPUT PORTS 1~6**

**Table 9 – Defined Contents of Programmable Output Ports 1~6**

No.	Type	Description
0	Not Used	
1	Custom Period Output 1	Details of function description please see the following.
2	Custom Period Output 2	
3	Custom Period Output 3	
4	Custom Period Output 4	
5	Custom Period Output 5	
6	Custom Period Output 6	
7	Custom Combined Output 1	
8	Custom Combined Output 2	
9	Custom Combined Output 3	
10	Custom Combined Output 4	
11	Custom Combined Output 5	
12	Custom Combined Output 6	
13	Reserved	
14	Reserved	

No.	Type	Description
15	Air Flap Control	Action when over speed shutdown and emergence stop. It can close the air inflow to stop the engine as soon as possible.
16	Audible Alarm	Action when warning and shutdown alarms occur. It can connect the annunciator externally. When "Alarm Mute" configurable input port is active or any key on the panel is pressed, it can remove the alarm. When new alarms occur, it will output again.
17	Louver Control	Action when engine is cranking and disconnect when engine stopped completely.
18	Fuel Pump Control	It is controlled by fuel pump of level sensor's limited threshold.
19	Heater Control	It is controlled by heating of temperature sensor's limited threshold.
20	Cooler Control	It is controlled by cooler of temperature sensor's limited threshold.
21	Fuel Pre-supply Output	In standby status, "Fuel Pre-supply" output is active, it will cycle output based on the pre-set "Fuel Pre-supply Rest Time" and "Fuel Pre-supply Time"; if "Fuel Pre-supply Rest Time" is set as 0h, it will not output. "Fuel Pre-supply Time" is outputting before starting. If the pre-heat time is not configured, the fuel pre-supply phase outputs; if pre-heat time is configured, the preheat phase outputs.
22	Reserved	
23	Oil Pre-lubrication Output	Action in period of pre-heating, cranking and crank rest time.
24	Remote Control	This port is controlled by RS485 communication port.
25	Reserved	
26	Reserved	
27	Reserved	
28	Crank Relay Output	Action when engine is cranking and disconnect when start successfully.
29	Fuel Relay Output	Action when engine is cranking and disconnect when stopped completely.
30	Idle Control	Used for engine which has idles. Close before starting and open when in high-speed warming up; Close during stopping idle mode and open when stop is completed. In other status, if idle control input is active or idle key is pressed, relay will close and start output.
31	Speed Raise Output	Action in warming up period and controlled by speed regulation while in normal running.
32	Speed Drop Output	Action between the periods from "Stop Idle Time" to "Wait Stop Time" and controlled by speed regulation while in normal running.
33	Energize to Stop	Used for engines with ETS electromagnet. Close when stop idle is over and open when pre-set "ETS delay" is over.
34	Reserved	
35	ECU Stop	Used for ECU engine and control its stop.
36	ECU Power Supply	Used for ECU engine and control its power.
37	Reserved	



No.	Type	Description
38	Crank Success Output	Close when detects crank success signal.
39	Normal Running Output	Action when engine is normal running.
40	Reserved	
41	Reserved	
42	Common Alarm	Action when common warning and shutdown alarm occurs.
43	Common Shutdown Alarm	Action when common shutdown alarm occurs.
44	Common Warning Alarm	Action when common warning alarm occurs.
45	Reserved	
46	Battery Over Voltage	Action when battery over voltage warning alarm occurs.
47	Battery Under Voltage	Action when battery under voltage warning alarm occurs.
48	Charging Failure	Action when charging failure warning alarm occurs.
49	Reserved	
50	ECU Warning	Indicate ECU sends a warning signal.
51	ECU Shutdown	Indicate ECU sends a shutdown signal.
52	ECU Comm. Failure	Indicate controller cannot communicate with ECU.
53	Reserved	
54	Reserved	
55	D-driven Pump Start	Output when suction pump set as diesel-driven suction pump.
56	D-driven Pump Stop	Output when suction pump set as diesel-driven suction pump.
57	E-driven Pump Start	Output when suction pump set as electronic-driven suction pump. It stops output when engine stopped.
58	Reserved	
59	Input 1 Active	Action when input port 1 is active
60	Input 2 Active	Action when input port 2 is active
61	Input 3 Active	Action when input port 3 is active
62	Input 4 Active	Action when input port 4 is active
63	Input 5 Active	Action when input port 5 is active
64	Reserved	
65	Reserved	
66	Reserved	
67	Emergency Stop Alarm	Action when emergency stop alarm occurs.
68	Crank Failure Alarm	Action when crank failure alarm occurs.
69	Stop Failure Warning	Action when stop failure alarm occurs.
70	Under Speed Warn	Action when under speed warn occurs.
71	Under Speed Shutdown	Action when under speed shutdown alarm occurs.
72	Over Speed Warn	Action when over speed warn occurs.
73	Over Speed Shutdown	Action when over speed shutdown alarm occurs.
74	Reserved	
75	Reserved	
76	Bypass Control Output	The input port is configured as "Water Gun On/Off Status Input" and is output between the "Start Idle" and "Stop Idle" when input is active.
77	Reserved	
78	Reserved	
79	High Temp Warning	Action when high temperature warning alarm occurs.

No.	Type	Description
80	Low Temp Warning	Action when low temperature warning alarm occurs.
81	High Temp Shutdown	Action when hi-temperature shutdown alarm occurs.
82	Reserved	
83	Engine Low OP Warning	Action when low oil pressure warning occurs.
84	Engine Low OP Shutdown	Action when low oil pressure shutdown occurs.
85	Oil Pressure Sensor Open	Action when oil pressure sensor is open circuit.
86	Reserved	
87	Sensor 1 High Warning	Action when flexible sensor 1 high warning occurs.
88	Sensor 1 Low Warning	Action when flexible sensor 1 low warning occurs.
89	Sensor 1 High Shutdown	Action when flexible sensor 1 high shutdown occurs.
90	Sensor 1 Low Shutdown	Action when flexible sensor 1 low shutdown occurs.
91	Over Flow Shutdown	Action when engine over flow shutdown alarm occurs.
92	Over Flow Warning	Action when engine over flow warning alarm occurs.
93	Sensor 2 High Warning	Action when flexible sensor 2 high warning occurs.
94	Sensor 2 Low Warning	Action when flexible sensor 2 low warning occurs.
95	Sensor 2 High Shutdown	Action when flexible sensor 2 high shutdown occurs.
96	Sensor 2 Low Shutdown	Action when flexible sensor 2 low shutdown occurs.
97	Sensor 3 High Warning	Action when flexible sensor 3 high warning occurs.
98	Sensor 3 Low Warning	Action when flexible sensor 3 low warning occurs.
99	Sensor 3 High Shutdown	Action when flexible sensor 3 high shutdown occurs.
100	Sensor 3 Low Shutdown	Action when flexible sensor 3 low shutdown occurs.
101	Sensor 4 High Warning	Action when flexible sensor 4 high warning occurs.
102	Sensor 4 Low Warning	Action when flexible sensor 4 low warning occurs.
103	Sensor 4 High Shutdown	Action when flexible sensor 4 high shutdown occurs.
104	Sensor 4 Low Shutdown	Action when flexible sensor 4 low shutdown occurs.
105	Reserved	
106	Reserved	
107	Reserved	
108	Reserved	
109	Reserved	
110	Reserved	
111	Reserved	
112	Reserved	
113	In Stop Mode	Action when system is in stop mode.
114	In Manual Mode	Action when system is in manual mode.
115	In Auto Mode	Action when system is in auto mode.
116	Reserved	
117	Reserved	
118	Reserved	
119	Reserved	

### 8.2.2 CUSTOM PERIOD OUTPUT

Defined period output is composed by 2 parts, period output S1 and condition output S2.



While S1 and S2 are **TRUE** synchronously, OUTPUT;

While S1 or S2 is **FALSE**, NOT OUTPUT.

Period output S1, can set engine's one or more period output freely, can set the delayed time and output time after entering into period.

Condition output S2, can set as any conditions in output ports.

**▲NOTE:** When delay time and output time both are 0 in period output S1, it is TRUE in this period.

Output period: crank

Delay output time: 2s

Output time: 3s

Condition output contents: output port 1 is active

Close when condition output active/inactive: close when active (disconnect when inactive);

Output port 1 active, after enter "crank time" and delay 2s, this defined period output is outputting, after 3s, stop outputting;

Output port 1 inactive, defined output period is not outputting.

### 8.2.3 CUSTOM COMBINED OUTPUT

Defined combination output is composed by 3 parts, OR condition output S1, OR Condition Output S2, AND condition output S3.

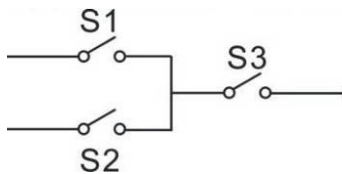

S1 or S2 is **TRUE**, and S3 is **TRUE**, defined combination output is outputting;

S1 and S2 are **FALSE**, or S3 is **FALSE**, defined combination output is not outputting.

**▲NOTE:** S1, S2, S3 can be set as any contents except for "defined combination output" in the output setting.

**▲NOTE:** 3 parts of defined combination output (S1, S2, and S3) couldn't include or recursively include themselves.

Contents of OR condition output S1: output port 1 is active;

Close when OR condition output S1 is active /inactive: close when active (disconnect when inactive);

Contents of OR condition output S2, output port 2 is active;

Close when OR condition output S2 is active /inactive: close when active (disconnect when inactive);

Contents of AND condition output S3: output port 3 is active;

Close when AND condition output S3 is active /inactive: close when active (disconnect when inactive);

When input port 1 active or input port 2 active, if input port 3 is active, defined combination output is outputting; If input port 3 inactive, defined combination output is not outputting;

When input port 1 inactive and input port 2 inactive, whatever input port 3 is active or not, defined combination output is not outputting.

SmartGen

### 8.3 DEFINED CONTENTS OF PROGRAMMABLE INPUT PORTS

**Table 10 – Defined Contents of Programmable Input Ports**

No.	Type	Description
0	Users Configured	Including following functions, Indication: indicate only, not warning or shutdown. Warning: warn only, not shutdown. Shutdown: alarm and shutdown immediately Never: input inactive. Always: input is active all the time. From crank: detecting as soon as start. From safety on: detecting after safety on delay.
1	Reserved	
2	Alarm Mute	Can prohibit “Audible Alarm” output when input is active.
3	Alarm Reset	Can reset shutdown alarm when input is active.
4	Reserved	
5	Lamp Test	All LED indicators are illuminated when input is active.
6	Panel Lock	All keys in panel is inactive except UP/DOWN/CONFIRM keys. Parameters cannot be configured when panel locked, but users can set language, check event logs and controller information. There is  in the bottom right corner in LCD when input is active.
7	Crank Success Input	When this function is active, it means the engine is started successfully. If this function is configured, the speed and oil pressure crank success conditions will be invalid.
8	Idle Mode	Enter into idle mode when input is active.
9	Auto Stop Inhibit	In <b>Auto</b> mode, during engine normal running, when input is active, inhibit engine shutdown automatically.
10	Auto Start Inhibit	In <b>Auto</b> mode, inhibit engine start automatically when input is active.
11	Scheduled Run Inhibit	In <b>Auto</b> mode, inhibit scheduled run engine when input is active.
12	Reserved	
13	Idle/High Speed (Memory)	In the normal running, it enters idle mode when input is active; return back to last adjusted high-speed value when input is inactive. It is only active for the current start and still run to rated speed for next start.
14	Idle/High Speed	Enter into idle mode when input is active; return back to high-speed running when input is inactive.
15	Idle/High Speed (Manual)	In <b>Auto</b> mode, it doesn't return back to idle mode when input is active; In <b>Manual</b> mode, it enters idle mode when input is active; return back to high-speed running when input is inactive.
16	Reserved	
17	Reserved	
18	D-driven Suction Pump Started	When input port is active, it indicates diesel driven

No.	Type	Description
		suction pump started successfully.
19	Press. to Suction Pump	When input port is active, it indicates pressure has been to suction pump.
20	Water Gun On/Off Input	Normal status: if input is active, bypass control is output between start idle to stop idle period. Idle running status: if input is active, engine operates idle running to normal running, meanwhile, bypass control starts output (if configured).
21	Alarm Stop Inhibit	All shutdown alarms are inhibited except for emergency stop and over speed shutdown.(Override mode)
22	Instrument Mode	All outputs are inhibited in this mode.
23	Reserved	
24	Reset Maintenance Time	Controller will set maintenance 1 time and date as default when input is active.
25	External Charging Failure	When input is active, charging failure warning alarm occurs.
26	High Temp Shutdown	Connect to sensor digital input.
27	Low OP Shutdown	Connect to sensor digital input.
28	Remote Start	In <b>Auto</b> mode, when input is active, engine can be started automatically.
29	Remote Stop	In <b>Auto</b> mode, when input is active and remote start input is inactive, engine can be stopped automatically.
30	High Water Level Input	In <b>Auto</b> mode, when input is active, engine can be started automatically (drain flood)
31	Low Water Level Input	In <b>Auto</b> mode, when input is active and high water level input is inactive, engine can be stopped automatically (drain flood)
32	Manual Start Input	In <b>Auto</b> mode, when input is active, engine can be started automatically; when input is inactive, engine can be stopped automatically.
33	Reserved	
34	Simulate Stop key	An external button (unlatched) can be connected and pressed as simulate panel.
35	Simulate Manual key	
36	Simulate Auto key	
37	Simulate Start key	
38	Simulate Speed Regulation key	
39-51	Reserved	
52	Raise Speed Input	An external button (unlatched) can be connected, manually control speed adjustment.
53	Drop Speed Input	

**8.4 SELECTION OF SENSORS**

**Table 11 – Sensors Selection**

No.	Items	Description	Remark
1	Temperature Sensor	0 Not used 1 Custom Resistor Curve 2 Custom (4-20)mA Curve 3 Custom Voltage Curve 4 VDO 5 CURTIS 6 VOLVO-EC 7 DATCON 8 SGX 9 SGD 10 SGH 11 PT100 12-15 Reserved	Defined resistance's range is (0~1)KΩ, default is SGD sensor.
2	Pressure Sensor	0 Not used 1 Custom Resistor Curve 2 Custom (4-20)mA Curve 3 Custom Voltage Curve 4 VDO 10bar 5 CURTIS 6 VOLVO-EC 7 DATCON 10bar 8 SGX 9 SGD 10 SGH 11 -15 Reserved	Defined resistance's range is (0~1)KΩ, default is SGD sensor.
3	Fuel Level Sensor	0 Not used 1 Custom Resistor Curve 2 Custom (4-20)mA Curve 3 Custom Voltage Curve 4 SGD 5 SGH 6 -15 Reserved	Defined resistance's range is (0~1)KΩ, default is SGD sensor.
4	Flow Sensor	0 Not used 1 Custom Resistor Curve 2 Custom (4-20)mA Curve 3 Custom Voltage Curve 4 -15 Reserved	

## 8.5 CONDITIONS OF CRANK DISCONNECT SELECTION

**Table 12 – Crank Disconnect Conditions**

No.	Setting description
0	Engine Speed
1	Oil pressure
2	Oil pressure + Engine Speed

**NOTE:**

- There are 2 conditions to make starter disconnected with engine, engine speed and oil pressure can be used separately. We recommend that oil pressure should be used with speed sensor together, in order to make the starter motor separated with engine immediately and can check crank disconnect exactly.
- Speed sensor is the magnetic equipment which be installed in starter for detecting flywheel teeth.
- When set as speed sensor, must ensure that the number of flywheel teeth is as same as setting, otherwise, “over speed shutdown” or “under speed shutdown” may be caused.
- If engine without speed sensor please don’t select corresponding items, otherwise, “crank failure” or “loss speed signal” may be caused.
- If engine without oil pressure sensor, please don’t select corresponding items.

## 8.6 MAINTENANCE SETTING

**Table 13 – Maintenance Setting**

Item	Content	Description
Enable Choose	0: Disabled, 1: Enabled	Choose maintenance function is active or not.
Maintenance Time	(0-30000)h	This time is the hours from the maintenance is enabled to the maintenance is required.
Maintenance Due Action	0: No Action; 1: Warning; 2: Shutdown; 3: Indication.	Alarm action when maintenance left time is 0.
Pre-alarm A Time	(0-30000)h	Maintenance remaining time.
Pre-alarm A Action	Same with maintenance time due actions.	Action when remaining time arrives at pre-alarm A time.
Pre-alarm B Time	(0-30000)h	Maintenance remaining time.
Pre-alarm B Action	Same with maintenance time due actions.	Action when remaining time arrives at pre-alarm B time.
Maintain Timing	0: Running Time 1: Real Time Clock	The timing of maintenance.
Reset Maintenance		After maintenance completion, through this item to reset maintenance time.
Maintenance Description		Users can configure maintenance name, like Change Engine Oil.

## 9 PARAMETERS SETTING



























Press  key and enter into setting menu after HEM4100 is powered on. The menu list is as













below:

- >Return
- >Parameters Set
- >Override Mode
- >Language
- >Event Log
- >Module Info

Select "Parameters Set" and input the password (default is 0318) to enter setting interface.

Parameters setting process as below:

<p>Parameters Set &gt;Return &gt;Module Set</p>	<p>Screen 1: Enter Setting, press   to change settings, press  to confirm and enter setting (Screen 2), press  to return. Select "return" and press confirm key to back to the previous screen.</p>
<p>&gt;Timers Set &gt;Engine Set</p>	<p>Screen 2: Press   to change settings, press  to enter setting (Screen 3), press  to return (Screen 1). Select "return" and press confirm key to back to the previous screen1.</p>
<p>Timers Set &gt;Return &gt;Start Delay &gt;Stop Delay &gt;Preheat Delay</p>	<p>Screen 3: Press  and move cursor, select the value and press   to modify. Press  to save your modification. Then press  to return (Screen 2).</p>
<p>Start Delay 00001s</p>	<p>Screen 4: Press , select and modify the value (same method with Screen 2 and Screen 3).</p>
<p>Timers Set &gt;Return &gt;Start Delay &gt;Stop Delay &gt;Preheat Delay</p>	<p>Screen 5: Set sensor shutdown parameters. Select &gt;Over Shutdown, press  to enter setting, then press  again to enter Screen 5, press   to select setting, then press  to save and meanwhile the cursor will move down (as Screen 6).</p>
<p>Over Shutdown Enable Choose: Enabled SetVal: +00098 Delay 00003s</p>	<p>Screen 6: Press   to change plus or minus, then press  to next bit. After setting finished, press  to enter delay setting. If no need to modify, press  to return.</p>
<p>Over Shutdown Enable Choose: Enabled SetVal: +00098 Delay 00003s</p>	

<p>Suction Pump Crank Set 0: Not Used</p>	<p>Screen 7: Pump crank setting. Select &gt;Suction Pump Crank Set, press  to enter setting, press  again to enter Screen 7, press   to select setting (as Screen 8).</p>
<p>Suction Pump Crank Set 1:D-driven Suction Pump Fault Shutdown Delay 00090s</p>	<p>Screen 8: Press   to show more setting information. Press  to configure next setting (such as Screen 9). If no need to change, press  to return.</p>
<p>Suction Pump Crank Set 1:D-driven Suction Pump Fault Shutdown Delay 00090s</p>	<p>Screen 9: Press  and move cursor, select the value and press   to modify. Press  to save your modification. Then press  to return.</p>

**NOTE:**

- Please modify parameters (eg: Crank disconnect conditions, programmable input/output configuration, delay, etc) in standby status, otherwise shutdown or faults may occur.
- Over threshold must be greater than under threshold, otherwise over and under will turn up simultaneously.
- Please set return value correctly when setting warning alarm, otherwise the controller can't alarm normally. When setting over warn, the return value should be set less than setting value; when setting under warn, the return value should be set greater than setting value.
- Programmable inputs can't be set as same value, otherwise it won't arise valid function. But programmable outputs can be set same.

**10 SENSORS SETTING**

- When reselect sensors, the sensor curve will be transferred into the standard value. For example, if temperature sensor is SGD, its sensor curve is SGD; if select the SGX, the temperature sensor curve is SGX curve.
- When there is difference between standard sensor curves and using sensor, user can adjust it in “curve type”.
- When input the sensor curve, X value must be input from small to large, otherwise, mistake occurs.
- If select sensor type as “None”, sensor curve is not working.
- If corresponding sensor has alarm switch only, user must set this sensor as “None”, otherwise, maybe there is shutdown or warning.
- The headmost or backmost values in the vertical coordinates can be set as same as below,

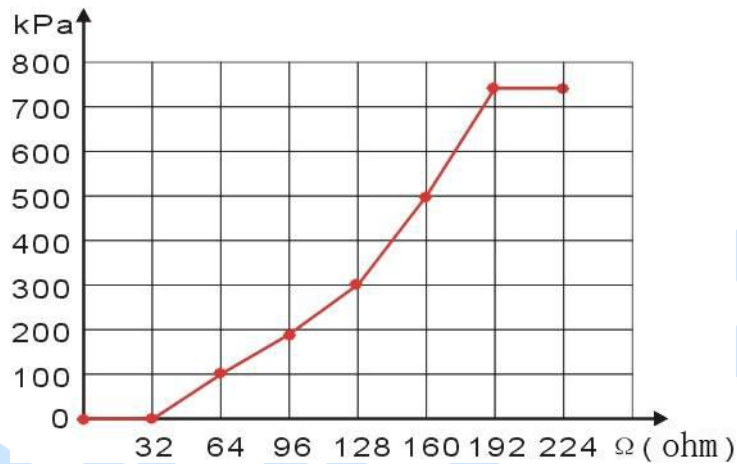

**Fig.4 – Curve Setting**

**Table 14 – Normal Pressure Unit Conversion Form**

Item	N/m <sup>2</sup> pa	kgf/cm <sup>2</sup>	bar	psi
1Pa	1	1.02x10 <sup>-5</sup>	1x10 <sup>-5</sup>	1.45x10 <sup>-4</sup>
1kgf/cm <sup>2</sup>	9.8x10 <sup>4</sup>	1	0.98	14.2
1bar	1x10 <sup>5</sup>	1.02	1	14.5
1psi	6.89x10 <sup>3</sup>	7.03x10 <sup>-2</sup>	6.89x10 <sup>-2</sup>	1

## 11 COMMISSIONING

Please make the following procedures checking before commissioning,

- a) Ensure all the connections are correct and wires diameter is suitable.
- b) Ensure that the controller DC power has fuse, controller's positive and negative connect to starting battery correctly.
- c) Take proper action to prevent engine to crank disconnect (e. g. Remove the connection wire of fuel valve). If checking is OK, make the starting battery power on, controller will executive routine.
- d) Press "start" button, engine will start. After the setting crank attempts, controller will send signal of crank failure; then press "stop" to reset controller.
- e) Recover the action of stop engine start (e. g. Connect wire of fuel valve), press start button again, engine will start. If everything goes well, engine will normal run after idle running (if idle run be set). During this time, please watch for engine's running situations.
- f) If there is any other question, please contact SmartGen's service personnel.

SmartGen

**12 TYPICAL APPLICATION**

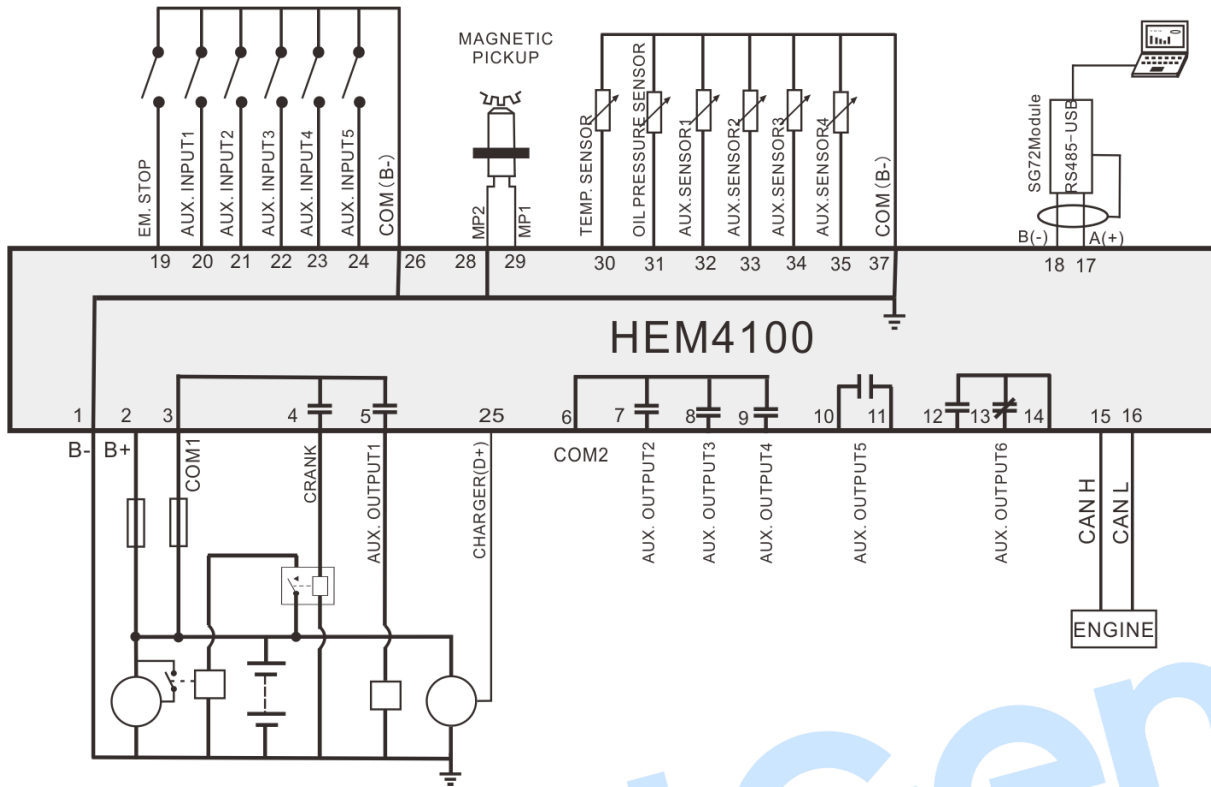

**Fig.5 - HEM4100 Typical Application Diagram**

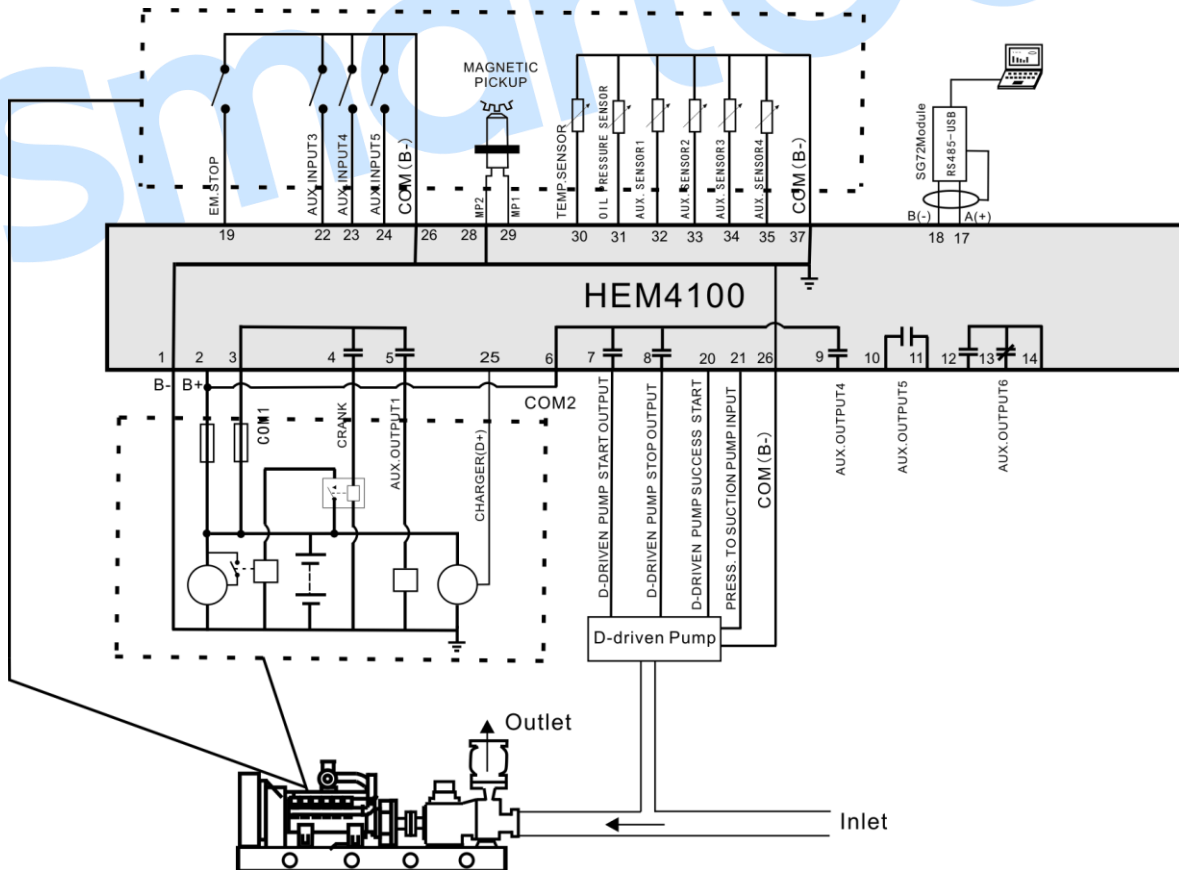

**Fig.6 - Connect to D-driven Suction Pump Typical Application Diagram**

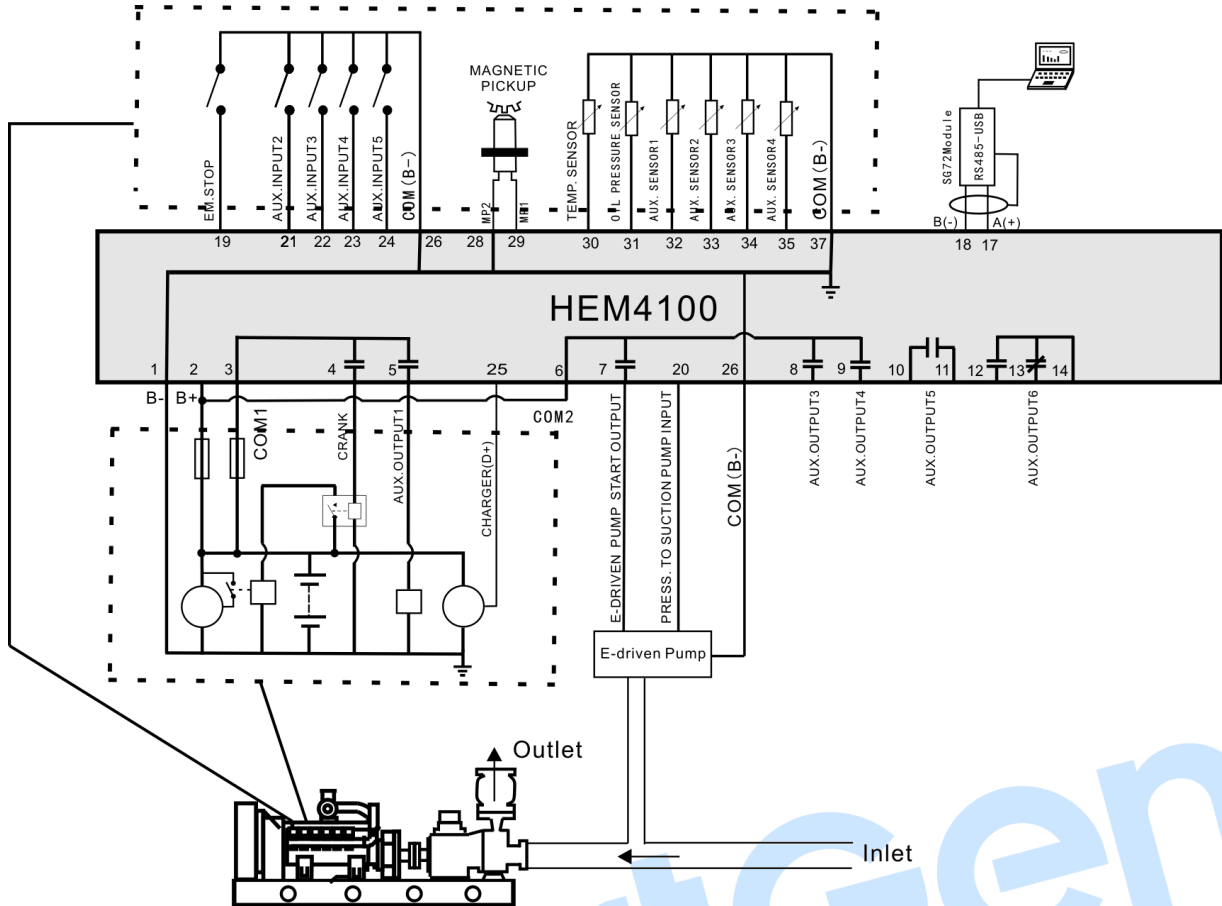

Fig.7 – Connect to E-driven Suction Pump Typical Application Diagram

## 13 INSTALLATION

### 13.1 FIXING CLIPS

HEM4100 controller designed as panel mounting, fixed by the clips.

- Withdraw the fixing clip screw (turn anticlockwise) until it reaches proper position.
- Pull the fixing clip backwards (towards the back of the module) ensuring four clips are inside their allotted slots.
- Turn the fixing clip screws clockwise until they are fixed on the panel.

**NOTE:** Care should be taken not to over tighten the screws of fixing clips.

### 13.2 OVERALL DIMENSION AND CUTOUT

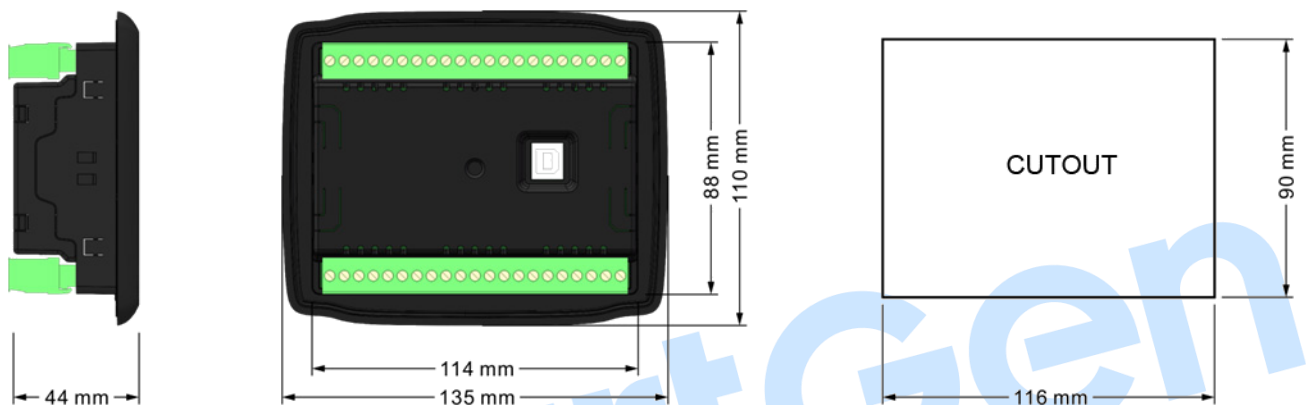

**Fig.8 – Overall Dimensions and Cutout**

#### — BATTERY VOLTAGE INPUT

HEM4100 controller can suit for widely range of battery voltage DC (8~35)V. Negative of battery must be connected with the engine shell. Diameter of wire that connects from power supply to battery must be over 1.5mm<sup>2</sup>. If floating charger configured, please firstly connect output wires of charger to battery's positive and negative directly, then, connect wires from battery's positive and negative to controller's positive and negative input ports in order to prevent charge disturbing the controller's normal working.

#### — SPEED SENSOR INPUT

Speed sensor is the magnetic equipment which be installed in starter and for detecting flywheel teeth. Its connection wires to controller should apply for 2 cores shielding line. The shielding layer should connect to No. 28 terminal in controller while another side is hanging in air. The else two signal wires are connected to No.28 and No.29 terminals in controller. The output voltage of speed sensor should be within AC (1~24)V (effective value) during the full speed. AC12V is recommended (in rated speed). When install the speed sensor, let the sensor is spun to contacting flywheel first, then, port out 1/3 lap, and lock the nuts of sensor at last.

#### — OUTPUT AND EXPAND RELAYS

All outputs of controller are relay contact output type. If need to expand the relays, please add freewheel diode to both ends of expand relay's coils (when coils of relay have DC current) or, increase resistance-capacitance return circuit (when coils of relay have AC current), in order to prevent disturbance to controller or others equipment.

## 14 CONNECTIONS OF CONTROLLER WITH J1939 ENGINE

**14.1 CUMMINS ISB/ISBE**

**Table 15 – Connector B**

Terminals of controller	Connector B	Remark
Fuel relay output	39	
Starting relay output	-	Connect with starter coil directly
Auxiliary output port 1	Expand 30A relay, battery voltage of 01, 07, 12, 13 is supplied by relay	ECU power Set Auxiliary output 1 as “ECU power”

**Table 16 – 9 Pins Connector**

Terminals of controller	9 pins connector	Remark
-	SAE J1939 shield	CAN communication shielding line (connect with ECU terminal only)
CAN(H)	SAE J1939 signal	Impedance 120Ω connecting line is recommended.
CAN(L)	SAE J1939 return	Impedance 120Ω connecting line is recommended.

**Engine type: Cummins ISB**

**14.2 CUMMINS QSL9**

Suitable for CM850 engine control module.

**Table 17 – 50 Pins Connector**

Terminals of controller	50 pins connector	Remark
Fuel relay output	39	
Starting relay output	-	Connect to starter coil directly

**Table 18 – 9 Pins Connector**

Terminals of controller	9 pins connector	Remark
-	SAE J1939 shield-E	CAN communication shielding line (connect with ECU terminal only)
CAN(H)	SAE J1939 signal-C	Impedance 120Ω connecting line is recommended.
CAN(L)	SAE J1939 return-D	Impedance 120Ω connecting line is recommended.

**Engine type: Cummins-CM850**



### 14.3 CUMMINS QSM11 (IMPORT)

It is suitable for CM570 engine control module. Engine type is QSM11 G1, QSM11 G2.

**Table 19 – C1 Connector**

Terminals of controller	C1 connector	Remark
Fuel relay output	5&8	Outside expand relay, when fuel output, making port 5 and port 8 of C1 be connected
Starting relay output	-	Connect to starter coil directly

**Table 20 – 3 Pins Data Link Connector**

Terminals of controller	3 pins data link connector	Remark
-	C	CAN communication shielding line (connect with ECU terminal only)
CAN(H)	A	Impedance 120Ω connecting line is recommended.
CAN(L)	B	Impedance 120Ω connecting line is recommended.

**Engine type: Cummins ISB**

### 14.4 CUMMINS QSX15-CM570

It is suitable for CM570 engine control module. Engine type is QSX15.

**Table 21 – 50 Pins Connector**

Terminals of controller	50 pins connector	Remark
Fuel relay output	38	Oil spout switch
Starting relay output	-	Connect to starter coil directly

**Table 22 – 9 Pins Connector**

Terminals of controller	9 pins connector	Remark
-	SAE J1939 shield-E	CAN communication shielding line (connect with ECU terminal only)
CAN(H)	SAE J1939 signal-C	Impedance 120Ω connecting line is recommended.
CAN(L)	SAE J1939 return-D	Impedance 120Ω connecting line is recommended.

**Engine type: Cummins QSX15-CM570**

## 14.5 CUMMINS GCS-MODBUS

It is suitable for GCS engine control module. Use RS485-MODBUS to read information of engine. Engine types are QSX15, QST30, QSK23/45/60/78 and so on.

**Table 23 – D-SUB Connector 06**

Terminals of controller	D-SUB connector 06	Remark
Fuel relay output	5&8	Outside expand relay, when fuel output, making port 05 and 08 of the connector 06 be connected.
Starting relay output	-	Connect to starter coil directly

**Table 24 – D-SUB Connector 06**

Terminals of controller	D-SUB connector 06	Remark
-	20	CAN communication shielding line (connect with ECU terminal only)
RS485+	21	Impedance 120Ω connecting line is recommended.
RS485-	18	Impedance 120Ω connecting line is recommended.

**Engine type: Cummins QSK-MODBUS, Cummins QST-MODBUS, Cummins QSX-MODBUS**

## 14.6 CUMMINS QSM11

**Table 25 – Engine OEM Connector**

Terminals of controller	OEM connector of engine	Remark
Fuel relay output	38	
Starting relay output	-	Connect with starter coil directly
CAN(H)	46	Impedance 120Ω connecting line is recommended.
CAN(L)	37	Impedance 120Ω connecting line is recommended.

**Engine type: common J1939**

**14.7 CUMMINS QSZ13**

**Table 26 – Engine OEM Connector**

Terminals of controller	OEM connector of engine	Remark
Fuel relay output	45	
Starting relay output	-	Connect to starter coil directly
Programmable output 1	16&41	Setting to idle speed control; normally close output. Making 16 connect to 41 during high-speed running of controller via external expansion relay.
Programmable output 2	19&41	Setting to pulse raise speed control; normally open output. Making 19 connect with 41 for 0.1s during high-speed warming of controller via external expansion relay.
CAN(H)	1	Impedance 120Ω connecting line is recommended.
CAN(L)	21	Impedance 120Ω connecting line is recommended.

**Engine type: QSZ13, adjust speed can be realized.**

**14.8 DETROIT DIESEL DDEC III/IV**

**Table 27 – Engine CAN Port**

Terminals of controller	CAN port of engine	Remark
Fuel relay output	Expand 30A relay; battery voltage of ECU is supplied by relay.	
Starting relay output	-	Connect to starter coil directly
CAN(H)	CAN(H)	Impedance 120Ω connecting line is recommended.
CAN(L)	CAN(L)	Impedance 120Ω connecting line is recommended.

**Engine type: Common J1939**

## 14.9 DEUTZ EMR2

**Table 28 – F Connector**

Terminals of controller	F connector	Remark
Fuel relay output	Expand 30A relay; battery voltage of terminal 14 is supplied by relay. Fuse is 16A.	
Starting relay output	-	Connect to starter coil directly
-	1	Connect to battery negative pole
CAN(H)	12	Impedance 120Ω connecting line is recommended.
CAN(L)	13	Impedance 120Ω connecting line is recommended.

**Engine type: VolvoEDC4**

## 14.10 JOHN DEERE

**Table 29 – 21 Pins Connector**

Terminals of controller	21 pins connector	Remark
Fuel relay output	G,J	
Starting relay output	D	
CAN(H)	V	Impedance 120Ω connecting line is recommended.
CAN(L)	U	Impedance 120Ω connecting line is recommended.

**Engine type: John Deere**

## 14.11 MTU MDEC

Suitable for MTU engines, 2000 series, 4000series

**Table 30 – X1 Connector**

Terminals of controller	X1 connector	Remark
Fuel relay output	BE 1	
Starting relay output	BE 9	
-	E	CAN communication shielding line (connect with one terminal only)
CAN(H)	G	Impedance 120Ω connecting line is recommended.
CAN(L)	F	Impedance 120Ω connecting line is recommended.

**Engine type: MTU-MDEC-303**

## 14.12 MTU ADEC (SMART MODULE)

It is suitable for MTU engine with ADEC (ECU8) and SMART module.

**Table 31 – ADEC (X1 port)**

Terminals of controller	ADEC (X1 port)	Remark
Fuel relay output	X1 10	X1 Terminal 9 Connected to negative of battery
Starting relay output	X1 34	X1 Terminal 33 Connected to negative of battery

**Table 32 – SMART (X4 port)**

Terminals of controller	SMART (X4 port)	Remark
CAN(H)	X4 1	Impedance 120Ω connecting line is recommended.
CAN(L)	X4 2	Impedance 120Ω connecting line is recommended.

**Engine type: MTU-ADEC**

**14.13 MTU ADEC (SAM MODULE)**

It is suitable for MTU engine with ADEC (ECU7) and SAM module.

**Table 33 – ADEC (X1 port)**

Terminals of controller	ADEC (X1 port)	Remark
Fuel relay output	X1 43	X1 Terminal 28 Connected to negative of battery
Starting relay output	X1 37	X1 Terminal 22 Connected to negative of battery

**Table 34 – SAM (X23 port)**

Terminals of controller	SAM (X23 port)	Remark
CAN(H)	X23 2	Impedance 120Ω connecting line is recommended.
CAN(L)	X23 1	Impedance 120Ω connecting line is recommended.

**Engine type: Common J1939**

#### 14.14 PERKINS

It is suitable for ADEM3/ADEM4 engine control module. Engine type is 2306, 2506, 1106, and 2806.

**Table 35 – Connector**

Terminals of controller	Connector	Remark
Fuel relay output	1, 10, 15, 33, 34	
Starting relay output	-	Connect to starter coil directly
CAN(H)	31	Impedance 120Ω connecting line is recommended.
CAN(L)	32	Impedance 120Ω connecting line is recommended.

**Engine type: Perkins**

#### 14.15 SCANIA

It is suitable for S6 engine control module. Engine type is DC9, DC12, and DC16.

**Table 36 – B1 Connector**

Terminals of controller	B1 connector	Remark
Fuel relay output	3	
Starting relay output	-	Connect to starter coil directly
CAN(H)	9	Impedance 120Ω connecting line is recommended.
CAN(L)	10	Impedance 120Ω connecting line is recommended.

**Engine type: Scania**

#### 14.16 VOLVO EDC3

Suitable engine control mode is TAD1240, TAD1241, and TAD1242.

**Table 37 – “Stand alone” Connector**

Terminals of controller	“Stand alone” connector	Remark
Fuel relay output	H	
Starting relay output	E	
Auxiliary output 1	P	ECU power Set output 1 as “ECU power”

**Table 38 – “Data bus” Connector**

Terminals of controller	“Data bus” connector	Remark
CAN(H)	1	Impedance 120Ω connecting line is recommended.
CAN(L)	2	Impedance 120Ω connecting line is recommended.

**Engine type: Volvo**

**▲NOTE:** When this engine type is selected, preheating time should be set to at least 3 seconds.

**14.17 VOLVO EDC4**

Suitable engine types are TD520, TAD520 (optional), TD720, TAD720 (optional), TAD721, TAD722, and TAD732.

**Table 39 – Connector**

Terminals of controller	Connector	Remark
Fuel relay output	Expand 30A relay; battery voltage of terminal 14 is supplied by relay. Fuse is 16A.	
Starting relay output	-	Connect to starter coil directly
	1	Connected to negative of battery
CAN(H)	12	Impedance 120Ω connecting line is recommended.
CAN(L)	13	Impedance 120Ω connecting line is recommended.

**Engine type: VolvoEDC4**

## 14.18 VOLVO-EMS2

Volvo Engine types are TAD734, TAD940, TAD941, TAD1640, TAD1641, and TAD1642.

**Table 40 – Engine CAN Port**

Terminals of controller	Engine CAN Port	Remark
Auxiliary output 1	6	ECU stop Set output 1 as "ECU Stop"
Auxiliary output 2	5	ECU power Set output 2 as "ECU power"
	3	Negative power
	4	Positive power
CAN(H)	1(Hi)	Impedance 120Ω connecting line is recommended.
CAN(L)	2(Lo)	Impedance 120Ω connecting line is recommended.

**Engine type: Volvo-EMS2, adjust speed can be realized.**

**▲NOTE:** When this engine type is selected, preheating time should be set to at least 3 seconds.

## 14.19 YUCHAI

It is suitable for Yuchai BOSCH common rail electronic-controlled engine.

**Table 41 – Engine 42 Pins Port**

Terminals of controller	Engine 42 pins port	Remark
Fuel relay output	1.40	Connect to engine ignition lock
Starting relay output	-	Connect to starter coil directly
CAN(H)	1.35	Impedance 120Ω connecting line is recommended.
CAN(L)	1.34	Impedance 120Ω connecting line is recommended.

**Table 42 – Engine 2 Pins Port**

Battery	Engine 2 pins port	Remark
Battery negative	1	Wire diameter 2.5mm <sup>2</sup>
Battery positive	2	Wire diameter 2.5mm <sup>2</sup>

**Engine type: BOSCH, adjust speed can be realized.**



**14.20 WEICHA**

It is suitable for Weichai BOSCH common rail electronic-controlled engine.

**Table 43 – Engine Port**

Terminals of controller	Engine port	Remark
Fuel relay output	1.40	Connect to engine ignition lock
Starting relay output	1.61	
CAN(H)	1.35	Impedance 120Ω connecting line is recommended.
CAN(L)	1.34	Impedance 120Ω connecting line is recommended.

**Engine type: GTSC1, adjust speed can be realized.**

**▲NOTE:** If there is any question of connection between controller and ECU communication, please feel free to contact SmartGen’s service personnel.



**15 FAULT FINDING**

**Table 44 – Fault Finding**

Symptoms	Possible Solutions
Controller no response with power	Check starting batteries; Check controller connection wirings; Check DC fuse.
Engine shutdown	Check the water/cylinder temperature is too high or not; Check DC fuse.
Controller emergency stop	Check emergence stop button is correct or not; Check whether the circuit is open.
Low oil pressure alarm after crank disconnect	Check the oil pressure sensor and its connections.
High water temp. alarm after crank disconnect	Check the water temperature sensor and its connections.
Shutdown alarm in running	Check related switch and its connections according to the information on LCD; Check auxiliary input ports.
Crank Failure	Check fuel circuit and its connections; Check starting batteries; Check speed sensor and its connections; Refer to engine manual.
Starter no response	Check starter connections; Check starting batteries.
RS485 communication abnormal	Check connections; Check COM port setting is correct or not; Check RS485's connections of A and B is reversed or not; Check RS485 conversion module is damaged or not; Check communication port of PC is damaged or not.
ECU communication failure	Check connections of CAN high and low polarity; Check if 120Ω resistor is correctly connected; Check if engine type is correct; Check if connections from controller to engine and output ports setting are correct.
ECU warning or shutdown	Get information from LCD of alarm page; If there is detailed alarm, check engine according to description. If not, please refer to engine manual according to SPN alarm code.

**16 PACKING LIST**

**Table 45 – Packing List**

No.	Name	Quantity	Remark
1	Controller	1	
2	Fixed Clip	2	
3	Certification	1	
4	User Manual	1	

---

SmartGen