



SmartGen
ideas for power

HAT560 Series
(HAT560 /HAT560B)
ATS CONTROLLER
USER MANUAL



SMARTGEN (ZHENGZHOU) TECHNOLOGY CO., LTD.



Chinese trademark

SmartGen English trademark

SmartGen — make your generator *smart*

SmartGen Technology Co., Ltd.

No.28 Jinsuo Road

Zhengzhou

Henan Province

P. R. China

Tel: 0086-371-67988888/67981888

0086-371-67991553/67992951

0086-371-67981000(overseas)

Fax: 0086-371-67992952

Web: <http://www.smartgen.com.cn>

<http://www.smartgen.cn>

Email: sales@smartgen.cn

All rights reserved. No part of this publication may be reproduced in any material form (including photocopying or storing in any medium by electronic means or other) without the written permission of the copyright holder.

Applications for the copyright holder's written permission to reproduce any part of this publication should be addressed to Smartgen Technology at the address above.

Any reference to trademarked product names used within this publication is owned by their respective companies.

Smartgen Technology reserves the right to change the contents of this document without prior notice.

Software Version

Version	Date	Note
1.0	2014-04-07	Original release.
1.1	2015-09-02	Modify the VITZRO wiring diagram.
1.2	2015-11-16	Change the name of VITZRO wiring diagram as VITZRO/PHETENG.
1.3	2015-12-29	Add VITZRO/PHETENG (Generator Start Control) wiring diagram.

Clarification of notation used within this publication.

SIGN	INSTRUCTION
 NOTE	Highlights an essential element of a procedure to ensure correctness.



CONTENT

1	OVERVIEW	4
2	PERFORMANCE AND CHARACTERISTICS	4
3	SPECIFICATION.....	6
4	OPERATING	7
4.1	OPERATION PANEL	7
4.2	KEY FUNCTION DESCRIPTION.....	7
5	LCD DISPLAY	8
5.1	MAIN SCREEN.....	8
5.2	MAIN MENU INTERFACE	9
6	PARAMETERS CONFIGURATION.....	10
6.1	PARAMETERS TABLE	11
6.2	INPUT/OUTPUT FUNCTION DESCRIPTION.....	14
7	EVENT LOG.....	16
8	TIMING START.....	17
9	COMMISSIONING	17
10	DATE AND TIME SETTING	18
11	LANGUAGE SETTING.....	18
12	CONTROLLER INFORMATION	18
13	ATS OPERATION	19
13.1	MANUAL OPERATION.....	19
13.2	AUTOMATIC OPERATION.....	19
13.3	ATS POWER SUPPLY.....	19
14	FAULT ALARM.....	20
15	COMMUNICATION CONFIGURATION.....	20
16	DESCRIPTION OF CONNECTING TERMINALS	21
17	TYPICAL WIRING DIAGRAM	23
18	INSTALLATION.....	27
19	FAULT FINDING	27

1 OVERVIEW

HAT560 series ATS controller is intelligent dual-supply module with configurable function, automatic measurement, LCD display, and digital communication. It combines digital, intelligence and networking. Automatic measurement and control can reduce incorrect operation. It is an ideal option for ATS.

The powerful Microprocessor contained within the unit allows for precision voltage (2-way-3-phase/single phase) measuring and make accurate judgment; in addition, the corresponding digital output port will active when there is over/under voltage, over/under frequency, loss of phase and other abnormal condition occurs. This controller has full consideration in various application of ATS (automatic transfer system) and can be directly used for specialized ATS, Contactor ATS, Air break ATS etc. It has compact structure, advanced circuits, simple wiring and high reliability, and can be widely used in electrical devices, automatic control and testing system of electric power, telecommunications, petroleum, coal, metallurgy, railways, municipal administration, intelligent building, etc.

2 PERFORMANCE AND CHARACTERISTICS

- 1) System type can set as: Mains (1#) & Generator (2#), Generator (1#) & Mains (2#), Mains (1#) & Mains (2#), Generator (1#) & Generator (2#).
- 2) 132x64 LCD with backlight, optional Chinese and English display, push-button operation.
- 3) Measure and display 2-way 3 phase Voltage and Frequency:

1#	2#
Line voltage (Uab, Ubc, Uca)	Line voltage (Uab, Ubc, Uca)
Phase voltage (Ua, Ub, Uc)	Phase voltage (Ua, Ub, Uc)
Frequency Hz	Frequency Hz
- 4) Over/under voltage, loss of phase, reverse phase sequence, over/under frequency protection.
- 5) Automatic/Manual mode. In manual mode, can force the switch to close or open;
- 6) All parameters can be set on site. With Two different passwords which ensures authorized staff operation only.
- 7) During commissioning, the genset can be set either on On-load or Off-load mode.
- 8) ATS Controller has function of automatic Re-closing.
- 9) Closing output signal can be set as on intervals or as continuous output.
- 10) Applicable for ATS of one neutral position, two neutral position and non-position.
- 11) Applicable for 2 isolated neutral line.
- 12) Real-time clock (RTC).
- 13) Event log can record 50 items circularly.
- 14) Scheduled start & stop generator (can be set as start genset once a day/week/month whether with load or not).
- 15) Can control two generators to work in a cycle, even the genset running time and crank rest time can be set.
- 16) Optional AC system or DC system.
- 17) With standard LINK communication interface. With "remote controlling, remote measuring, remote communication" function by the ModBus communication protocol. Can remote start/stop the genset and remote control the ATS to close or open.

- 18) Can check the current status of controller (digital input port, digital output port, over voltage, under voltage, over frequency, under frequency etc.).
- 19) Suitable for various AC systems (3 phase 4-wires, 3-phase 3-wires, single-phase 2-wire, and 2-phase 3-wire).
- 20) Modular design, self extinguishing ABS plastic shell, pluggable terminal, built-in mounting, compact structure with easy installation.

HAT560 series controller and its main functions are shown as following,

Function			
Type	DC Power Supply	AC Power Supply	AC Current/Power
HAT560	√	×	×
HAT560B	√	√ (LN220V)	×

SmartGen

3 SPECIFICATION





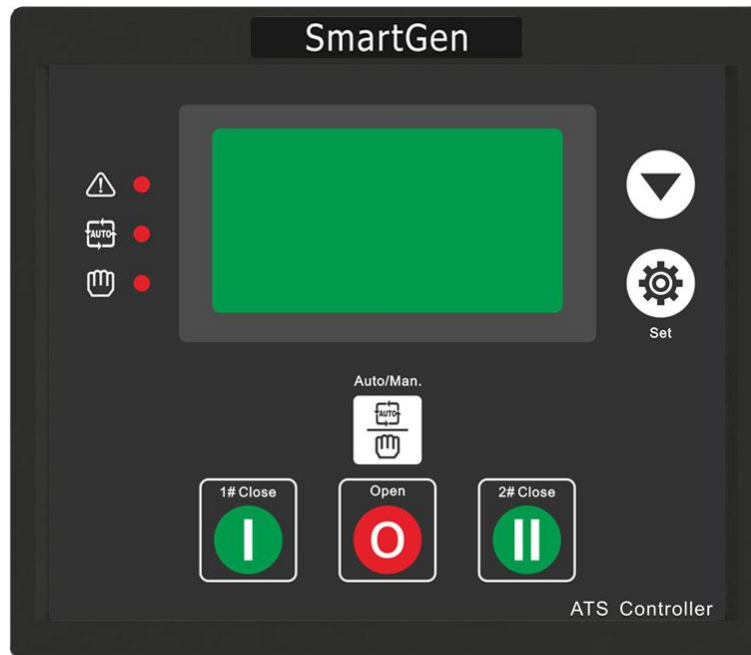

Items	Contents		
Operating Voltage	1. DC 8.0V~35.0V, continuous power supply. 2. AC170V~270V during AC power L1N1/L2N2 supply.		
Power Consumption	<3W (Standby mode: ≤2W)		
AC Voltage Input	AC system	HAT560	HAT560B
	3P4W (ph-N)	AC30V~AC360V	AC170V~AC277V
	3P3W (ph-ph)	AC60V~AC620V	Not used
	1P2W (ph-N)	AC30V~AC360V	AC170V~AC277V
	2P3W (ph-N)	AC30V~AC360V	AC170V~AC277V
Rated Frequency	50/60Hz		
Close Relay Output	16A AC250V Volts free output		
Auxiliary Relay Output 1	7A AC250V Volts free output		
Auxiliary Relay Output 2	7A AC250V Volts free output		
Auxiliary Relay Output 3	16A AC250V Volts free output		
Auxiliary Relay Output 4	16A AC250V Volts free output		
Digital Input	GND connect is active.		
Communication	LINK interface, MODBUS Protocol		
Case Dimensions	139mmx120mmx48mm		
Panel Cutout	130mmx111mm		
Working Conditions	Temperature: (-25~+70)°C; Humidity: (20~93)%RH		
Storage Condition	Temperature: (-25~+70)°C		
Protection Level	IP55 Gasket		
Insulation Strength	Apply AC2.2kV voltage between high voltage terminal and low voltage terminal; The leakage current is not more than 3mA within 1min.		
Weight	0.62kg		

4 OPERATING

4.1 OPERATION PANEL



4.2 KEY FUNCTION DESCRIPTION

	I# Manual Close	In Manual mode, switch on 1# power to load.
	Open	In Manual mode, switch off 1# or 2# power to off-load.
	II# Manual Close	In Manual mode, switch on 2# power to load.
	Manual/Auto Set	Press the button and controller enter into Manual or Auto mode.
	Menu /Confirm	Press the button to enter into menu interface; pressing and holding it to return to the main menu interface. When an alarm occurs, pressing and holding the button for more than 3s can remove alarm.
	Scroll Screen /Increase	Scroll the screen. In parameter setting, pressing this button can decrease values. Pressing and holding the button for more than 3s, there is a flash on the backlight to confirm the “always illuminated” mode is selected. Pressing and holding the button for more than 3s again, the backlight will extinguished which means the “normal display” mode is selected.

5 LCD DISPLAY

5.1 MAIN SCREEN

<pre> U1(L-L) 380 380 380V U2(L-L) 380 380 380V F1 50.0Hz F2 50.0Hz Present Status: MANUAL — — — — </pre>	<p>This screen shows: 1#/2# line voltage (L1-L2, L2-L3, and L3-L1), frequency, controller's working status, close/open information and load information.</p>
<pre> U1(L-N) 220 220 220V U2(L-N) 220 220 220V 2014-04-07 (1) 09:43:36 Present Status: MANUAL — — — — </pre>	<p>This screen shows: 1# and 2# 3 phase Voltage (L-N), real-time clock, controller's working status, close/open information and load information.</p>
<pre> 1# Under Volt 2# Volt normal Gens Start signal Out Present Status: AUTO — — — — </pre>	<p>First line: 1# working status Second line: 2# working status Third line: other working status Fourth line: alarm type and information. Fifth line: close/open information and load information</p>

Display of the #1 status (upper to lower)

No.	Item	Type	Description
1	1# Gens Alarm	Alarm	When 1# genset failure occurs, this will display.
2	1# Fail to Close	Alarm	When 1# close failure occurs, this will display.
3	1# Fail to Open	Alarm	When 1# open failure occurs, this will display.
4	1# Over Voltage	Indication	When 1# power supply voltage has exceeded the set value, this will display.
5	1# Loss of Phase	Indication	Loss of any phase of A, B and C.
6	1# Over Freq	Indication	When 1# power supply frequency is higher than the set value, this will display.
7	1# Under Freq	Indication	When 1# power supply frequency has fallen below the set value, this will display.
8	1# Under Volt	Indication	When 1# power supply voltage has fallen below the set value, this will display.
9	1# Phase Sequence Wrong	Warning	Phase sequence is not A-B-C.
10	1# Volt Normal	Indication	1# power supply voltage is within the setting range.

Display of the #2 status (upper to lower)

No.	Item	Type	Description
1	2# Gens Alarm	Alarm	When 2# genset failure occurs, this will display.
2	2# Fail to Close	Alarm	When 2# close failure occurs, this will display.
3	2# Fail to Open	Alarm	When 2# open failure occurs, this will display.
4	2# Over Voltage	Indication	When 2# power supply voltage has exceeded the setting value, this will display.
5	2# Loss of Phase	Indication	Loss of any phase of A, B and C.
6	2# Over Freq	Indication	When 2# power supply frequency is higher than the set value, this will display.
7	2# Under Freq	Indication	When 2# power supply frequency has fallen below the set value, this will display.
8	2# Under Volt	Indication	When 2# power supply voltage has fallen below the set value, this will display.
9	2# Phase Sequence Wrong	Warning	Phase sequence is not A-B-C.
10	2# Volt Normal	Indication	2# power supply voltage is within the setting range.

Display status of the other items (upper to lower)

No.	Item	Type	Description
1	Trip Alarm	Alarm	Trip alarm input is active.
2	Breaking Compulsorily	Warning	Breaking compulsorily input is active.
3	Gens Start Out	Indication	Start input is active.
4	Remote Start Input	Indication	This input is active when start the genset circularly.



NOTE:

Alarm: When alarm occurs, indicators will flash and this alarm signal won't be removed until long pressing  to reset.





Warning: When warning alarm occurs, alarm indicator will flash while extinguish when warning alarm is inactive. That is to say, warning alarm is not latched.

5.2 MAIN MENU INTERFACE





In the main screen, press  key will enter into the main menu interface.



<ol style="list-style-type: none"> 1. Exit 2. Parameters Set 3. Event Log 4. Scheduled Start 5. Commissioning 	<p>Press  key to choose parameters (the current line was highlighted with black) and then press  key to confirm, can enter into the corresponding display screen.</p>
<ol style="list-style-type: none"> 4. Scheduled Start 5. Commissioning 6. Date/Time 7. Language 6. Information 	

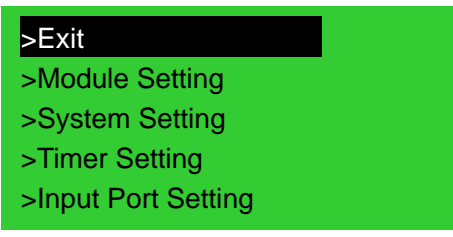



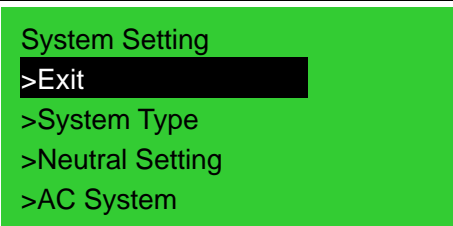
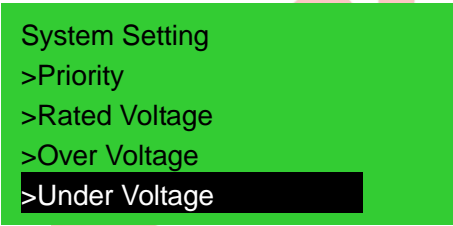
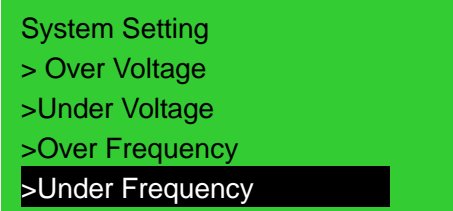

6 PARAMETERS CONFIGURATION

In the main interface, press  key, choose **2.Parameters setting** and press  again to parameter password confirmation interface. Press  to input the corresponding password 0~9; press  key to right move the bit, in fifth bit press  key to check password. If password is correct, enter into parameter setting interface, otherwise, exit directly. (Factory default password is **00318**.)

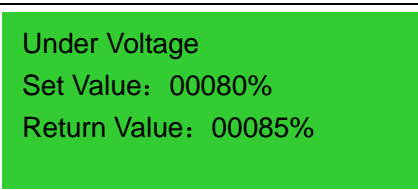
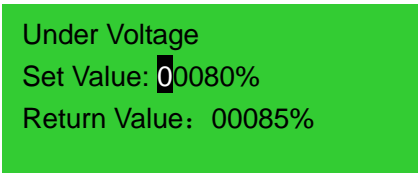
▲Note: Pressing and holding  for a long time can exit parameter setting menu directly and return to main interface.

 	<p>Press  key to choose parameters (the current line was highlighted with black) and then press  key to confirm, can enter into the corresponding display screen. Select >Exit will return to main display.</p>
--	---

  	<p>Press  key to choose parameters (the current line was highlighted with black) and then press  key to confirm, can enter into the corresponding display screen. Select >Exit will return to previous menu.</p>
--	--

 	<p>Press  button can scroll screen; Select one parameter and press  to enter into configuration status (the first digit of the current parameter was highlighted with black.) Press  to adjust the set value; press  key to right move the bit, in last bit press  key to confirm the set value.</p> <p>If the set value is within the setting range, the value will be saved into the internal memory of the controller; If it is beyond the range, then the parameters setting will not be saved.</p>
--	--

6.1 PARAMETERS TABLE

Parameters Item Table

No.	Item	Range	Default	Description
01	1# Volts Normal Delay	(0-9999)s	10	The delay from #1 power abnormal to normal.
02	1# Volts Abnormal Delay	(0-9999)s	5	The delay from #1 power normal to abnormal.
03	2# Volts Normal Delay	(0-9999)s	10	The delay from #2 power abnormal to normal.
04	2# Volts Abnormal Delay	(0-9999)s	5	The delay from #2 power normal to abnormal.
05	Close Time	(0-20)s	5	Pulse time of close relay. When it is 0, means output constantly.
06	Open Time	(1-20)s	5	Pulse time of open relay.
07	Transfer Interval	(0-9999)s	1	Interval time from 1# switch off to 2# switch on; or from 2# switch off to 1# switch on.
08	Transfer Delay Expired	(0-20.0)s	0.0	The prolongation output time of the close relay after the module receives a closing signal.
09	Again Close Delay	(0-20.0)s	1.0	When the breaker fail to open for the first time, then the module will close for the second time and the Again Close Delay begins, after the delay has expired, if still failed to open the second time, the module will send out fail to open alarm.
10	Again Open Delay	(0-20.0)s	1.0	When the breaker fail to close for the first time, then the module will open for the second time and the Again Open Delay begins, after the delay has expired, if still failed to close the second time, the module will send out fail to close alarm.
11	Gen Start Delay	(0-9999)s	1	When voltage is abnormal, start delay begins, after the start delay has expired, start signal will be initiated.
12	Gen Stop Delay	(0-9999)s	5	After the genset is start, when voltage is normal, stop delay begins, after the stop delay has expired, stop signal will be initiated.
13	Cycle Running Time	(1-1440)min	720	Gens cycle start running time.
14	Cycle Stop Time	(1-1440)min	720	Gens cycle stop time, that is to say it is the cycle stat running time of the other genset.
15	Wait Running	(0-9999)s	60	Failure identification time during genset cycle start running.
16	Rated Voltage	(100-600)V	230	AC system rated voltage.
17	Over Voltage	(100-150)%	120	Upper limit value of voltage; it is abnormal if the value has exceeded the set value.
18	Over Voltage Return	(100-150)%	115	Upper limit return value of voltage; it is normal only when the value has fallen below the set value.
19	Under voltage	(50-100)%	80	Lower limit value of voltage; it is abnormal if the value has fallen below the set value.
20	Under Voltage Return	(50-100)%	85	Lower limit return value of voltage; it is normal only when the value has fallen below the set value.
21	Over Frequency	(0.0-75.0)Hz	55.0	Upper limit value of frequency; it is abnormal if the

No.	Item	Range	Default	Description
				value has exceeded the set value.
22	Over Frequency Return	(0.0-75.0)Hz	52.0	Upper limit return value of frequency; it is normal only when the value has fallen below the set value.
23	Under Frequency	(0.0-75.0)Hz	45.0	Lower limit value of frequency; it is abnormal if the value has fallen below the set value.
24	Under Frequency Return	(0.0-75.0)Hz	48.0	Lower limit return value of frequency; it is normal only when the value has fallen below the set value.
25	Module Address	(1-254)	1	Communication address
26	Password		00318	For entering advanced parameters setting.
27	System Type	(0-3)	0	1.1# Mains 2# Gens 2.1# Gens 2# Mains 3.1# Mains 2# Mains 4.1# Gens 2# Gens
28	Neutral Setting	(0-2)	1	1) Two Breaking; 2) One Breaking; 3) No Breaking.
29	AC System	(0-3)	0	0: 3P4W; 1: 3P3W; 2: Single Phase; 3: 2P3W.
30	Priority Select	(0-2)	0	1. 1# Priority; 2. 2# Priority; 3. NO Priority
31	Aux. Output 1	(0-31)	15	0 Not used
32	Aux. Output 2	(0-31)	12	1 Critical failure
33	Aux. Output 3	(0-31)	24	2 Fail of Transfer
34	Aux. Output 4	(0-31)	27	3 Warning output 4 Alarm output(delay) 5 1# Normal volt 6 1# Abnormal volt 7 2# Normal volt 8 2# Abnormal volt 9 Reserved 10 Auto status output 11 Manual status output 12 Gens Start Output(N/O) 13 Gens Start Output(N/C) 14 1# Close output 15 1# Open output 16 2# Close output 17 2# Open output 18 Common Alarm output 19 Timing Commissioning 20 1# Close Status Output 21 2# Close Status Output



No.	Item	Range	Default	Description
				22 1# Gen Start Output(N/O) 23 2# Gen Start Output(N/O) 24 ATS Power A Phase 25 ATS Power B Phase 26 ATS Power C Phase 27 ATS Power N Phase 28 1# 2# Abnormal Volt 29 Reserved 30 Reserved 31 Reserved
35	Aux. Input 1	(0-13)	1	00.Not used
36	Aux. Input 2	(0-13)	0	01.Breaking compulsorily 02.Test off-load 03.Test on-load 04. Test Lamp 05. 1# Gens Alarm 06. 2# Gens Alarm 07. Remote start 08. Trip alarm 09. Reserved 10. Reserved 11. Reserved 12. Reserved 13. Reserved

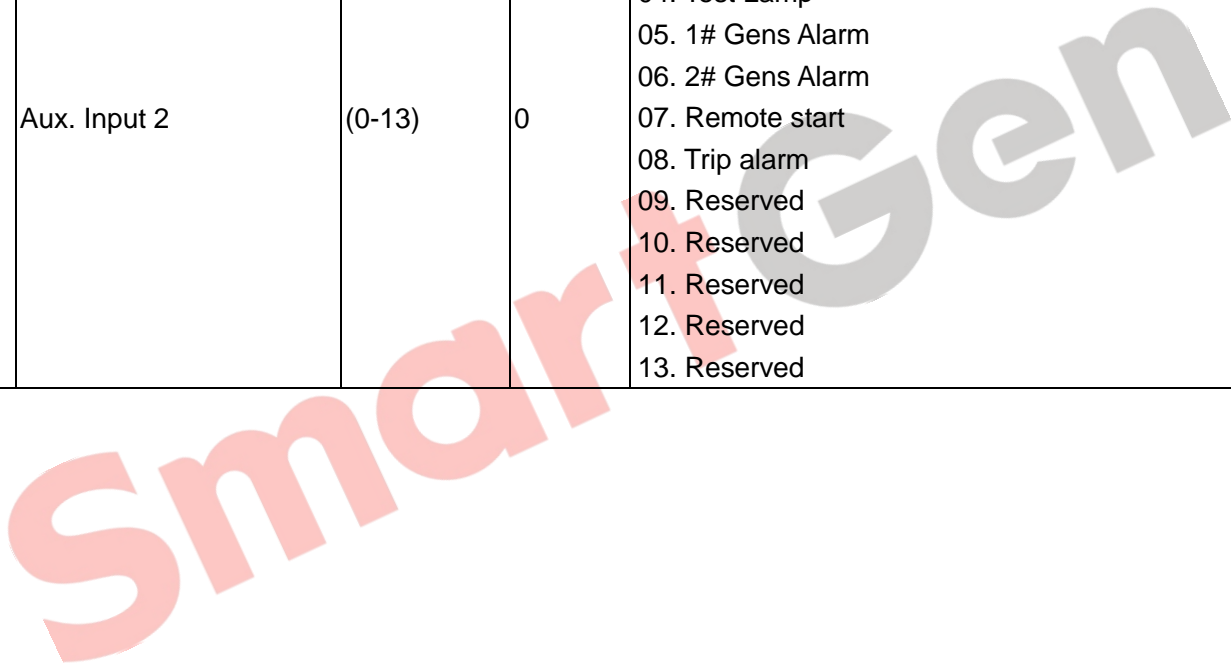

6.2 INPUT/OUTPUT FUNCTION DESCRIPTION



The input port functions are as below:

Item	Description
0 Not used	Invalid
1 Breaking compulsorily	No matter the genset is in manual mode or Auto mode, when the input is active, this will force the breaker to transfer the ATS to OFF position. "No Breaking" ATS is unavailable.
2 Test off-load	When active, controller will send a genset start signal immediately. When mains is normal, genset will not close the breaker.
3 Test On-Load	When active, controller will send genset start signal immediately. When mains is normal, genset will close the breaker.
4 Test lamp	When active, all LED lights on the front panel are illuminated and the backlight of the LCD is illuminated while the LCD screen is black in color.
5 1# Gens Alarm	In Cycle start, if the input is active, 1 # Gens start will be inhibited.
6 2# Gens Alarm	In Cycle start, if the input is active, 2 # Gens start will be inhibited.
7 Remote start	This input is necessary for cycle start generator.
8 Trip alarm	
9 Reserved	
10 Reserved	
11 Reserved	
12 Reserved	
13 Reserved	

The output functions are as below:

Item	Description
0 Not Used	Invalid
1 Critical Failure	“Fail of Transfer” also belongs to the critical failure alarm.
2 Fail of Transfer	1# closed failure, 1# open failure, 2# closed failure and 2# open failure also belong to the fail to transfer alarm.
3 Warning Alarm Output	1# reverse phase sequence; 2# reverse phase sequence, and breaking compulsory belong to general warning output.
4 Alarm Output (delay)	Output when there is critical failure occurs and the output will last for 60s.
5 1# Volts Normal	It will output when #1 voltage is normal.
6 1# Volts Abnormal	It will output when #1 voltage is abnormal.
7 2# Volts Normal	It will output when #2 voltages is normal.
8 2# Volts Abnormal	It will output when #2 voltages is abnormal.
9 Reserved	
10 Auto Status Output	It will output in auto mode.
11 Manual Status Output	It will output in manual mode.
12 Gens Start Output (N/O)	When generator starts output (Relay closed).
13 Gens Start Output(N/C)	When generator starts output (Relay opened).
14 1# Close Output	1# Switch ON signal output.
15 1# Open Output	1# Switch OFF signal output, for one breaking position breaks off output.
16 2# Close Output	2# Switch ON signal output.
17 2# Open Output	2# Switch OFF signal output.
18 Common Alarm Output	It include critical failure alarm and warning alarm.
19 Timing Commissioning	Schedulers start generator function.
20 1# Close Status Output	#1 Switch close output.
21 2# Close Status Output	#2 Switch close output.
22 1#Gen Start Output (N/O)	1# Gens start output.
23 2#Gen Start Output (N/O)	2# Gens start output.
24 ATS Power A Phase	ATS power supply.
25 ATS Power B Phase	
26 ATS Power C Phase	
27 ATS Power N Phase	
28 1#2# Volts Abnormal	Output when 1# voltage and 2# voltage are abnormal.
29 Reserved	
30 Reserved	
31 Reserved	



7 EVENT LOG



On the main screen press  key and select **3 Event log**, and then press  key again, the screen will show the event log interface as follow:

```

1# Close          01/50
1# Volt normal
2# Under Volt
2014-04-03 08:43:14

Long pressing  to exit
  
```

Press  key to select the corresponding record, and press  key to enter into detailed information interface.

In the detailed information interface, press  key can display the record information circularly. The detailed information include specific status of voltage, frequency and time and date. Press  will exit the current interface, while pressing  for a long time will return to main screen.

Event log information includes: event log type, 1# power supply, 2# power supply, 1# 3-phase voltage, 2# 3-phase voltage, 1# frequency, 2# frequency and the record date and time.

```

# 1 Close          01/50
1# Volt normal
2# Under Volt
2014-04-03 08:43:14
Long pressing  to exit
  
```

```

#1 Close          01/50
U1 L-N 220 220 220V
U2 L-N 0 100 220V
2014-04-03 08:43:14
Long pressing  to exit
  
```

```

#1 Close          01/50
F1 50.0Hz        F2 50.1Hz
2014-04-03      08:43:14
Long pressing  to exit
  
```

Event log type:

No.	Type	Description
1	1# Close	1# close signal output
2	2# Close	2# close signal output
3	1# Fail to Close	1# power supply can not connect to load.
4	2# Fail to Close	2# power supply can not connect to load.
5	1# Fail to Open	1# power supply can not disconnect to load.
6	2# Fail to Open	2# power supply can not disconnect to load.
7	Trip alarm	The input is active.
8	Breaking compulsorily	Breaking compulsorily input is active.

8 TIMING START

On the main screen press  key and select **4 Time start**, and then pressing  key, the screen will show the timing start interface as follow:

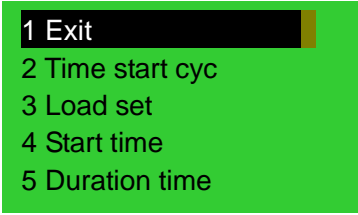

1 Exit
2 Time start cyc
3 Load set
4 Start time
5 Duration time

Time start cycle: Include inhibit start; start the genset single time, weekly or monthly.

Load set: Start the generator with load or without load.

Start time: The date and time of the genset starting.



Duration time: Generator continuously run time can be set on the duration of maximum time for 99 hours 59 minutes.

9 COMMISSIONING

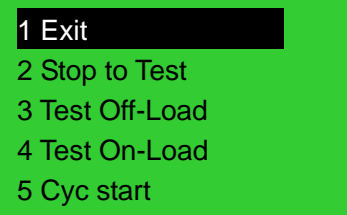
On the main screen press  key and select **5 Commissioning**, and then pressing  key, the screen will show the commissioning interface as follow:



1 Exit
2 Stop to Test
3 Test Off-Load
4 Test On-Load
5 Cyc start

Press  key to select corresponding function, and press  key to confirm.

TEST OFF-LOAD: It will send out a start signal immediately. After generator is normal, if mains is normal, the ATS will not act. The ATS will transfer the load to generator only when mains is abnormal. After mains return normal, the ATS will transfer the load to mains. Here the start generator signal will continuously output.

TEST ON-LOAD: It will send out a start generator signal immediately. After generator voltage is normal, the ATS will transfer the load to mains immediately regardless whether the mains is normal or not.

STOP TO TEST: The start generator signal will turn off immediately after pressing this key.

CYCLE START: When this mode is selected, generator start-signal will cyclic output according to the mains status. The cyclic time can be set by users. If generator failure occurs, start-signal won't be send out anymore by controller. If in manual mode, controller will keep the current status and stop the cycle start output.

Conditions and procedures for cycle start mode:



1. In automatic mode.
2. Output setting: 1# Gen start output (N/O Output) and 2 # Gen start output (N/O Output).
3. Input setting: remote start input.
4. Option of <Cycle running time> and <Cycle stop time> should be programmed.
5. Set the system type as 1# Gens & 2# Gens.
6. Set the proper < Wait Running > time, the default delay is 60s.

 **Note:** In manual mode, if the commissioning input is active, generator will output start-signal immediately, but the ATS will not transfer to load automatically except for operation manually by pressing key on the front panel.

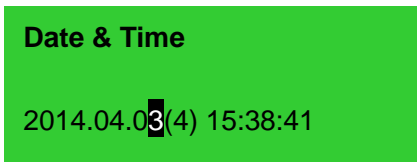

10 DATE AND TIME SETTING

On the main screen press  key and select **6 Date & Time**, and then pressing  key again, the screen will show the Date & Time Set interface as follow:





Press  to input the corresponding number 0~9; press  key to right move the bit, in the last bit press  key to save the settings.

11 LANGUAGE SETTING

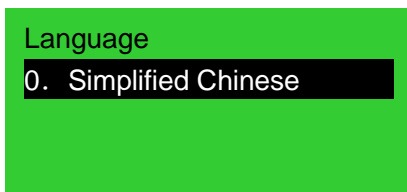

On the main screen press  key and select **7 Language**, press  again to enter into language setting interface and the screen will show the language interface as follow:



Press  to select the language and press  to confirm the setting.

Language option:Simplified Chinese/ English

12 CONTROLLER INFORMATION

On the main screen press  key and select **8 Controller information**, and then pressing  key again, the screen will show the controller information interface as follow:

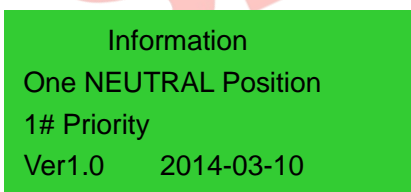



Display content includes neutral positions setting and priority choice and controller version and date information.

Long pressing  key will exit and return to main screen.

13 ATS OPERATION

13.1 MANUAL OPERATION

Manual mode is selected by pressing the  button; a LED besides the button will illuminate to confirm the operation.

- 1) Press , 1# close relay outputs immediately, if 1# close input is active, the 1# power supply connect to load.
- 2) Press , 2# close relay outputs immediately, if 2# close input is active, the 2# power supply connect to load.
- 3) Press , 1#/2# open relay outputs immediately, if 1#/2# close input is inactive, the 1#/2# power supply disconnect with load.

Note *1: For the ATS of no Neutral position, pressing  key is invalid.

13.2 AUTOMATIC OPERATION

A LED besides the Auto button will illuminate to confirm that the Auto mode is selected. The controller can automatically switch load to 1# or 2#.

13.3 ATS POWER SUPPLY

The power of ATS is supplied by controller, as long as one power is normal, this can ensure ATS voltage power supply normally and can be transferred properly.

Users should select power supply voltage (phase voltage or line voltage) based on ATS type. If choose phase voltage, connect the phase voltage of 1# and 2# (e.g. A phase) to normally close (Pin8) and normally open (Pin10) contact of auxiliary output 3; connect N phase of 1# and 2# to normally close (Pin13) and normally open (Pin11) contact of auxiliary output 4. And then connect the common output of auxiliary output3 and auxiliary output 4 to ATS power supplies. When controller power is ON, parameters can be set and also set the configurable output 3 as "ATS power A" while set the configurable output 4 as "ATS power N". If the ATS power supplied by Line Voltage, same procedures as above but change phase N to phase voltage and the auxiliary output 4 should be configured according to the set. Wiring diagrams are shown as following:

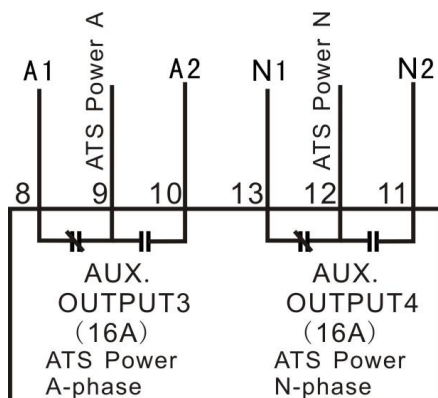

ATS phase voltage power supply

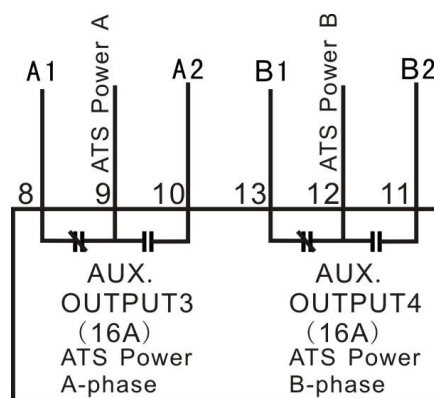

ATS line voltage power supply

Note: Normally Close (N/C) input voltage must come from 1# voltage.

14 FAULT ALARM

Critical Failure:

No.	Items	Type	Description
1	1# Gens Alarm	Alarm	1# genset failure occurs.
2	1# Fail to Close	Alarm	1# close failure occurs.
3	1# Fail to Open	Alarm	When 1# open failure occurs.
4	2# Gens Alarm	Alarm	2# genset failure occurs.
5	2# Fail to Close	Alarm	2# close failure occurs.
6	2# Fail to Open	Alarm	When 2# open failure occurs.
7	Trip alarm	Alarm	Trip alarm input is active.

Warning Types:

No.	Items	Type	Description
1	1# Phase Sequence Wrong	Warning	1# phase sequence is not A-B-C.
2	2# Phase Sequence Wrong	Warning	2# phase sequence is not A-B-C.
3	Breaking compulsorily	Warning	Breaking compulsorily input is active.

15 COMMUNICATION CONFIGURATION

HAT560 series controller equips with LINK communication port which can provide ATS transfer management to factories, telecom, industrial and civil buildings by using Modbus protocol via PC or system software and implements “remote control, remote measuring, remote communication” functions.

Communication parameters,

Module address 1 (range: 1-254, User-set)

Baud rate 9600 bps

Data bit 8bit

Parity bit None

Stop bit 1 bit or 2-bits(can be set via PC)

 **Note:** Select DC power supply please in order to keep the continuity of communication.

16 DESCRIPTION OF CONNECTING TERMINALS

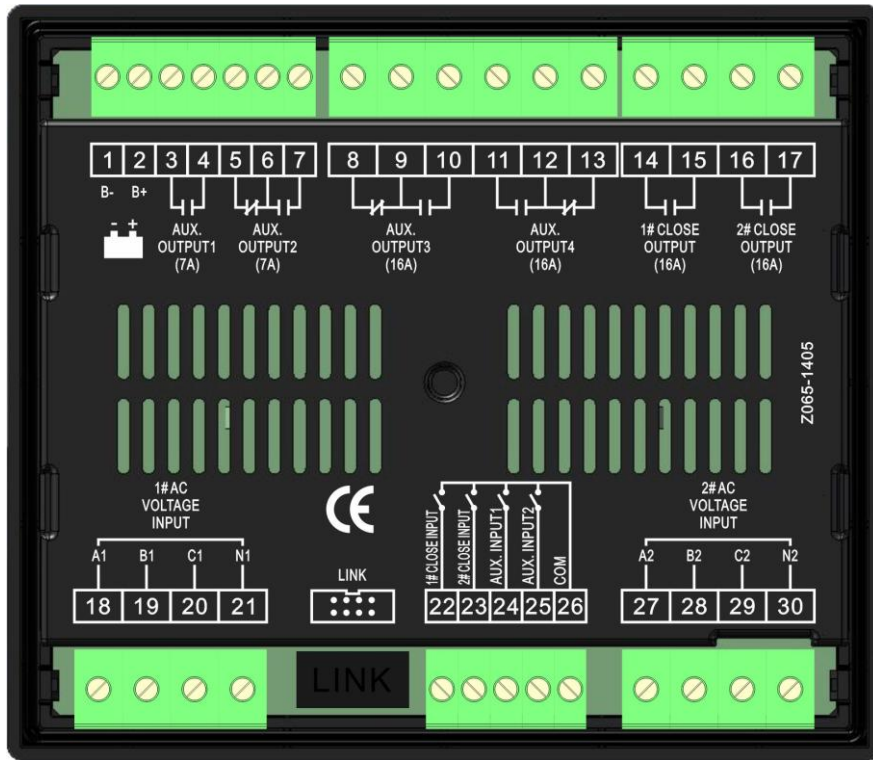

Terminal description,

NO.	Functions	Description	Remark
1	B-	Connected with negative of starter battery.	DC input B-
2	B+	Connected with positive of starter battery.	DC(8-35)V; Power supplied by controller.
3	Aux. output 1	Default: 1# open output	Relay contact output; Volts free; Rated 7A
4			
5		Normally Close	
6	Aux. output 2	COM	Relay contact output; Volts free; Rated 7A
7		Normally Open	
8	Aux. output 3	Normally Close	Default: ATS Power A
9		COM	
10		Normally Open	
11	Aux. output 4	Normally Open	Default: ATS Power N
12		COM	
13		Normally Close	
14	1# Close Output	Relay contact output; Volts free;	Relay contact output; Volts free; Rated 16A
15			
16	2# Close Output	Relay contact output; Volts free;	Relay contact output; Volts free; Rated 16A
17			
18	A1	1# AC System 3P4W voltage input	For single phase, only connect A1, N1
19	B1		
20	C1		
21	N1		



NO.	Functions	Description	Remark
22	1# Close Input	Detect the 1# ATS closing status. Auxiliary contact input.	Ground connected is active.
23	2# Close Input	Detect the 2# ATS closing status. Auxiliary contact input.	Ground connected is active.
24	Aux. Input 1	User-defined.	Ground connected is active.
25	Aux. Input 2	User-defined.	Ground connected is active.
26	COM	GND	
27	A2	2# AC System; 3P4W voltage input	For single phase, only connect A2, N2
28	B2		
29	C2		
30	N2		
LINK	Communication port	Used for PC communication/ program updating.	

SmartGen

17 TYPICAL WIRING DIAGRAM

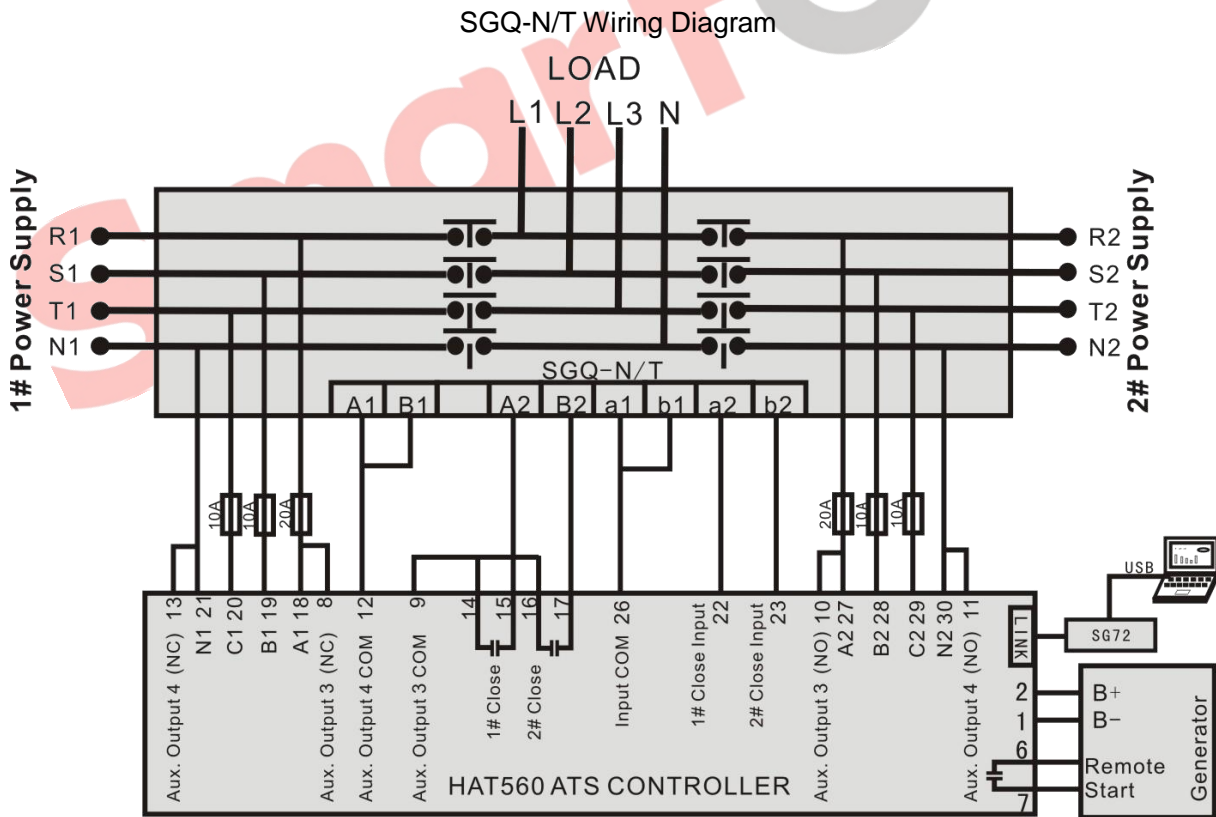
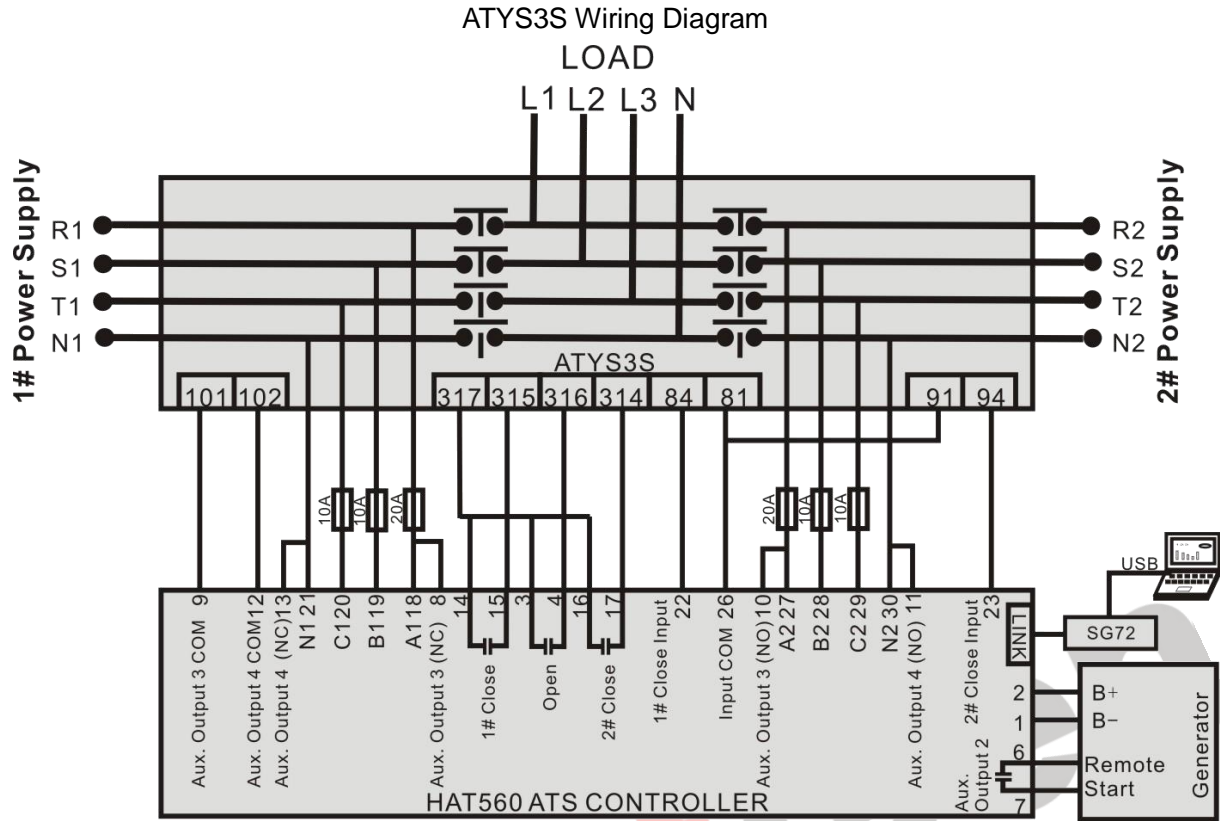

SGQ-M Wiring Diagram

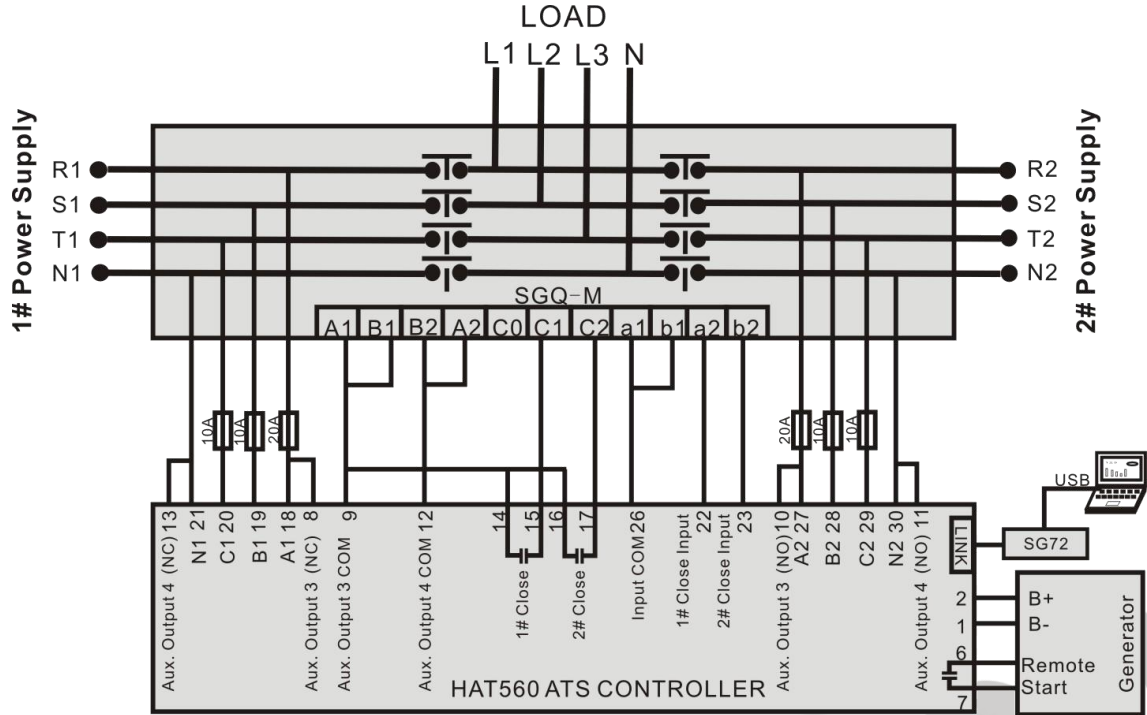

VITZRO/PHETENG Wiring Diagram

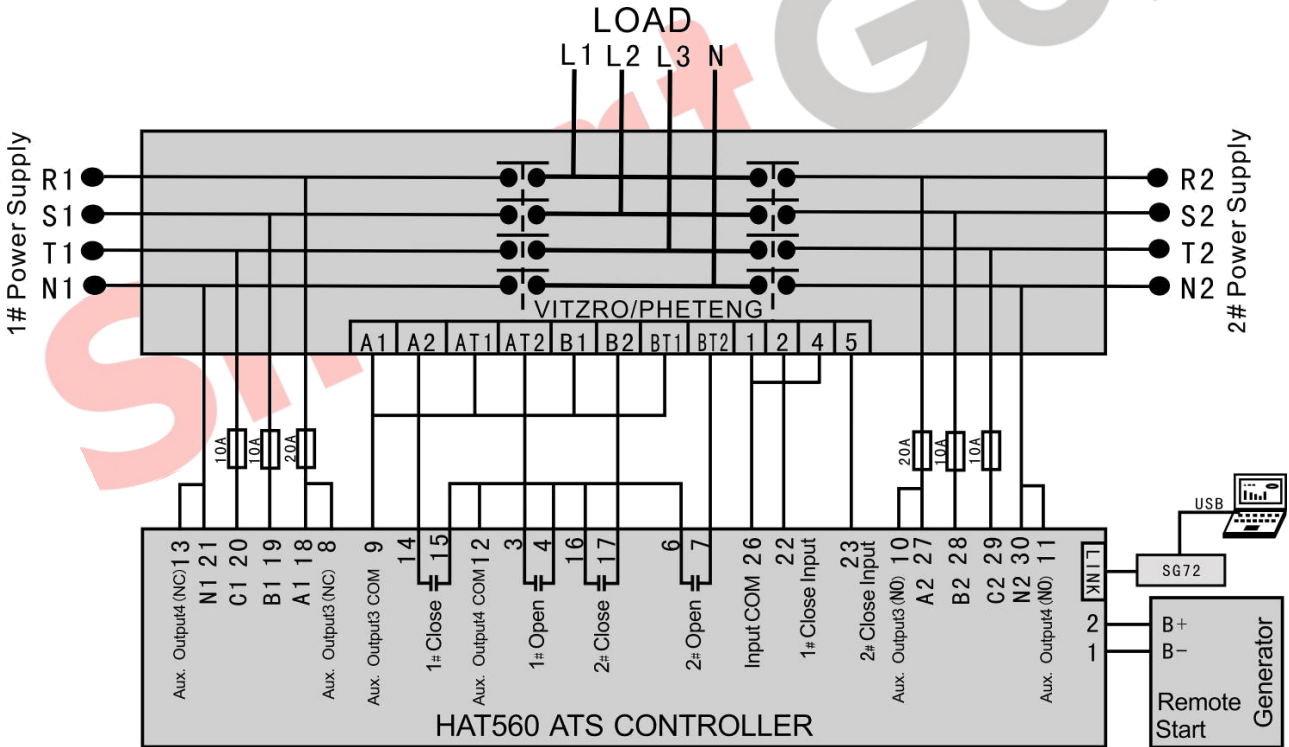

- ▲NOTE:
- Set auxiliary output 1 as: 15: 1# Open Output
 - Set auxiliary output 2 as: 17: 2# Open Output
 - Set auxiliary output 3 as: 24: ATS power A-phase
 - Set auxiliary output 4 as: 27: ATS power N-phase

VITZRO/PHETENG (Generator Start Control)

LOAD

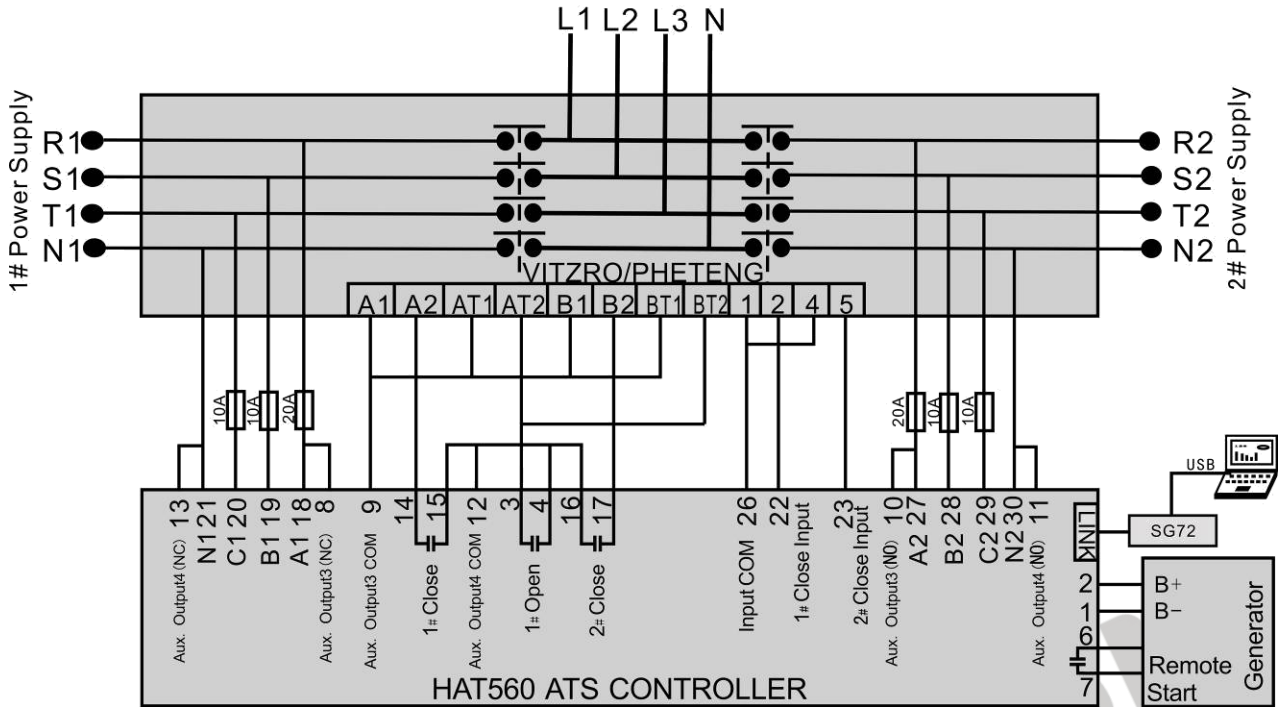

- NOTE:**
- Set auxiliary output 1 as: 15: 1# Open Output
 - Set auxiliary output 2 as: 12: Gen Start Output (N/O)
 - Set auxiliary output 3 as: 24: ATS power A-phase
 - Set auxiliary output 4 as: 27: ATS power N-phase

Contactor Wiring Diagram

LOAD

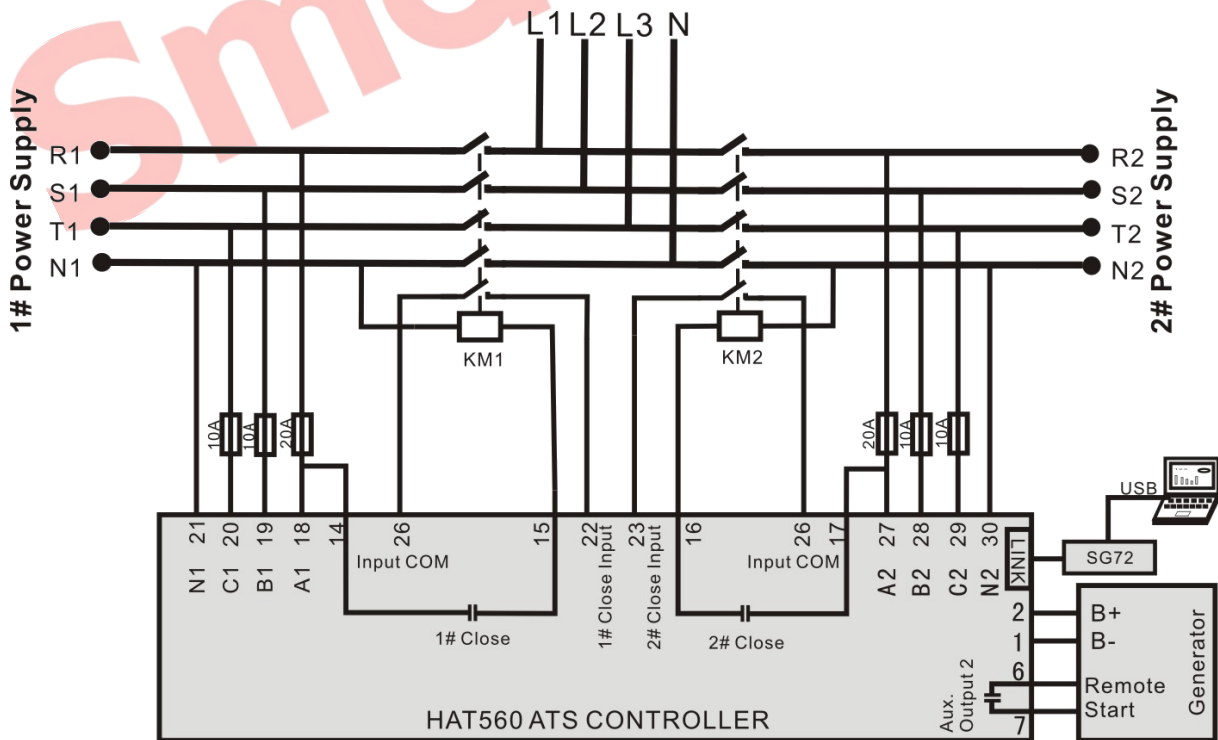

ATYSM3S Wiring Diagram

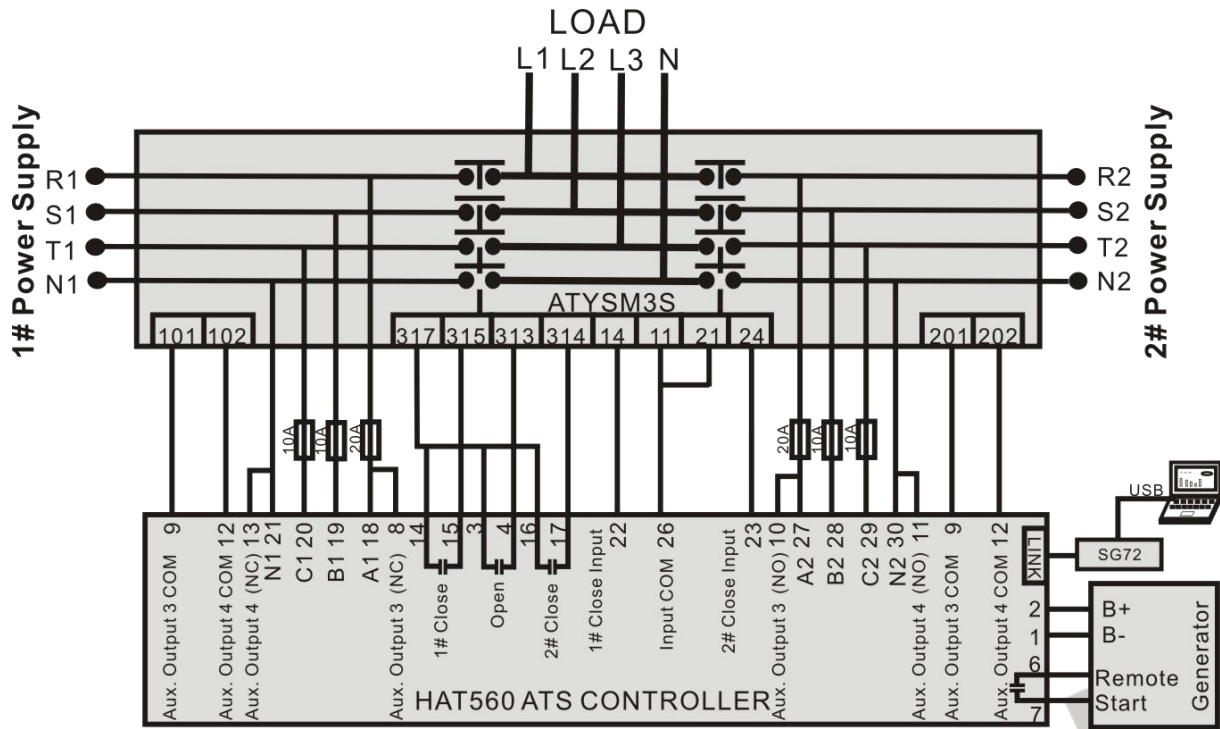

▲Note: The diagram is for reference only. Users should choose proper fuse capacity according to the actual power consumption. If there is no DC power supply, please select "Gen start output (Normally close)".

3-phase 3-wire Wiring Diagram
(take 1#Mains 2#Gens as example)

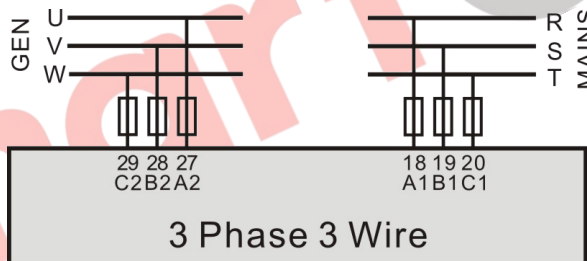

2-phase 3-wire Wiring Diagram
(take 1#Mains 2#Gens as example)

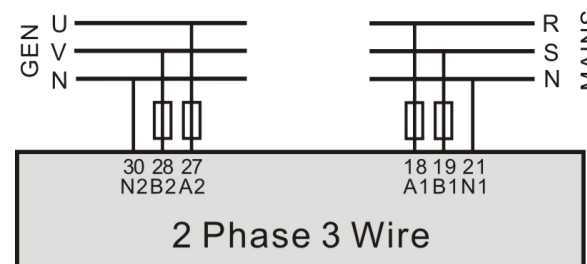

Single phase 2-wire Wiring Diagram
(take 1#Mains 2#Gens as example)

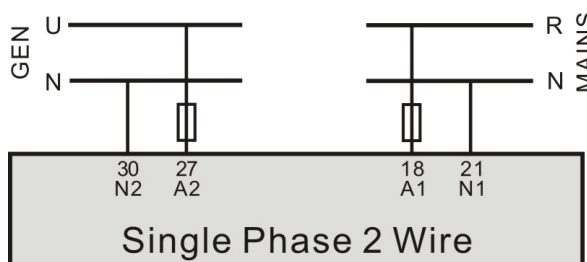

18 INSTALLATION

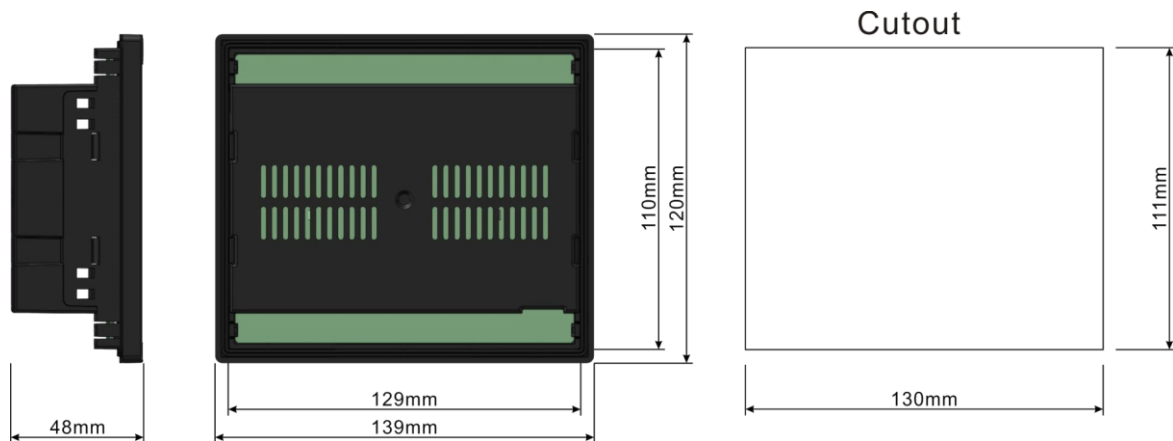

19 FAULT FINDING

Symptom	Possible Solutions
Controller no response with power.	Check starting batteries;
LINK communication failure	If SG72 module is fitted, check its connections. Check module address in parameters settings.
Auxiliary Output Error	Check auxiliary output connections, pay attention to normally open contact and normally close contact. Check the output settings in parameters settings.
Auxiliary Input Abnormal	Ensure that the auxiliary input is soundly connected to GND when it's active, while hung up when it is inactive. (⚠️Note: The input port will be possibly destroyed when connected with voltage)
Genset running while ATS not transfer	Check ATS. Check the connection wirings between the controller and the ATS. Ensure that the ATS Neutral position whether is same as the setting.