



SmartGen
ideas for power

HGM6100N-4G SERIES
(HGM6110N-4G/6120N-4G
/6110CAN-4G/6120CAN-4G)
GENSET CONTROLLER
USER MANUAL



SMARTGEN (ZHENGZHOU) TECHNOLOGY CO., LTD.



Chinese trademark

SmartGen English trademark

SmartGen – make your generator *smart*

SmartGen Technology Co., Ltd.

No.28 Jinsuo Road, Zhengzhou, Henan Province, China

Tel: +86-371-67988888/67981888/67992951

+86-371-67981000(overseas)

Fax: +86-371-67992952

Email: sales@smartgen.cn

Web: www.smartgen.com.cn

www.smartgen.cn

All rights reserved. No part of this publication may be reproduced in any material form (including photocopying or storing in any medium by electronic means or other) without the written permission of the copyright holder.

Applications for the copyright holder's written permission to reproduce any part of this publication should be addressed to SmartGen Technology at the address above.

Any reference to trademarked product names used within this publication is owned by their respective companies.

SmartGen Technology reserves the right to change the contents of this document without prior notice.

Table 1 - Software Version

Date	Version	Note
2020-11-06	1.0	Original release.
2021-04-08	1.1	1. Add a table header for "4G Setting"; 2. Modify the sequence number of parameter configuration, HGM6110-4G has no Mains PT Ratio.
2021-04-29	1.2	Add appendix : Table 45 of order models.

CONTENTS

1	OVERVIEW.....	5
2	PERFORMANCE AND CHARACTERISTICS	5
3	SPECIFICATION	7
4	OPERATION.....	8
4.1	KEYS DSCRIPTION	8
4.2	CONTROLLER PANEL	9
4.3	AUTOMATIC START/STOP OPERATION	10
4.4	MANUAL START/STOP OPERATION.....	11
4.5	EMERGENCY START	11
5	PROTECTION	11
5.1	WARNINGS.....	11
5.2	SHUTDOWN ALARMS.....	13
6	CONNECTIONS	15
7	PARAMETER RANGE AND DEFINITION	17
7.1	PARAMETER CONTENT AND RANGE TABLE	17
7.2	PROGRAMMABLE OUTPUT 1-4 TABLE	23
7.3	PROGRAMMABLE INPUT 1-5 TABLE.....	24
7.4	SENSOR SELECTION.....	25
7.5	CONDITIONS OF CRANK DISCONNECT	26
8	4G SETTING	27
9	SMS ALARM AND REMOTE CONTROL	27
9.1	SMS ALARM	27
9.2	SMS REMOTE CONTROL.....	27
10	PARAMETER SETTING	29
11	SENSOR SETTING.....	30
12	COMMISSIONING	31
13	TYPICAL APPLICATION	32
14	INSTALLATION	34
14.1	ANTENNA AND SIM CARD INSTALLATION	34
14.2	FIXING CLIPS (TORQUE).....	35
14.3	OVERALL DIMENSION AND PANEL CUTOUT	36
15	CONNECTIONS OF CONTROLLER WITH J1939 ENGINE.....	37
15.1	CUMMINS ISB/ISBE.....	37
15.2	CUMMINS QSL9.....	37
15.3	CUMMINS QSM11 (IMPORT).....	38
15.4	CUMMINS QSX15-CM570	38
15.5	CUMMINS GCS-MOVBUS	39
15.6	CUMMINS QSM11.....	39



15.7	CUMMINS QSZ13.....	39
15.8	DETROIT DIESEL DDEC III / IV.....	40
15.9	DEUTZ EMR2.....	40
15.10	JOHN DEERE.....	41
15.11	MTU MDEC.....	41
15.12	MTU ADEC(SMART MODULE).....	41
15.13	MTU ADEC(SAM MODULE).....	42
15.14	PERKINS.....	42
15.15	SCANIA.....	42
15.16	VOLVO EDC3.....	43
15.17	VOLVO EDC4.....	43
15.18	VOLVO-EMS2.....	44
15.19	YUCHAI.....	44
15.20	WEICHAH.....	44
16	FAULT FINDING.....	45
17	APPENDIX.....	46

SmartGen

1 OVERVIEW

HGM6100N-4G series automatic controller, integrating digital, intelligent and network techniques, is used for automatic control and monitoring system of genset. It can carry out functions of automatic start/stop, data measurement, alarm protection and three “remote” (remote control, remote measure and remote communication). The controller uses LCD display, optional display interface including Chinese, English, Spanish, Russian, Portuguese, Turkish, Polish and French with easy and reliable operation.

HGM6100N-4G series automatic controller uses 32-bit microprocessor which can achieve precision measurement, value adjustment, timing and threshold setting etc.. All the parameters can be configured from front panel or use USB interface (or RS485 interface) to adjust via PC. It can be widely used in all types of automatic control system for its compact structure, simple connections and high reliability.

HGM6100N-4G series automatic controller has network communication module inside, which can realize genset access to internet. After controller logging in cloud server, the unit data information (include GPS positioning, altitude, etc.) will be uploaded in real time to the corresponding cloud server. Users can monitor the genset and inquire the genset running status, the event log, as well as configure the parameters via cloud server by phone APP (ISO or Android) and computer terminal equipment. The network communication module also has SMS function.

2 PERFORMANCE AND CHARACTERISTICS

HGM6100N-4G series controller has four variants:

HGM6110N-4G/6110CAN-4G: Using for single unit automation, it controls genset to start/stop by remote start signal;

HGM6120N-4G/6120CAN-4G: Based on HGM6110N-4G/6110CAN-4G, it adds mains AC monitoring and mains/generator automatic switching control (AMF), especially suitable for the automation system composed by mains and generator;

Note 1: HGM6110CAN-4G/6120CAN-4G have RS485 port, HGM6110N-4G/6120N-4G without.

Note 2: HGM6110CAN-4G/6120CAN-4G have CAN port, HGM6110N-4G/6120N-4G without.

Note 3: HGM6110-4G is taken as an example to describe HGM6110N-4G /CAN-4G, HGM6120-4G is taken as an example to describe HGM6120N-4G/CAN-4G in this manual.

The main characteristics are as follows:

- 132*64 LCD display with backlight, eight optional languages interface (Chinese, English, Spanish, Russian, Portuguese, Turkey, Polish and French), push-button operation;
- Acrylic screen, improved wearable and scratch resistance property;
- Silica-gel panel and keys can well adapt to higher and lower temperature;
- With RS485 communication port, can achieve “three remote” functions via MODBUS protocol (available for the controller with RS485 port);
- With CANBUS port which can be connected to ECU with J1939, it not only can monitor frequently-used data (such as water temperature, oil pressure, rotated speed and fuel consumption, etc.) but also can control start, stop, high speed and low speed (controller with CANBUS port is needed) via CANBUS port;
- Adapt to 3P4W, 3P3W, 1P2W and 2P3W (120V/240V), 50Hz/60Hz AC power system;
- Can collect and display 3-phase voltage, 3-phase current, frequency, power parameter of

mains/gens;

Mains

Generator

Line voltage (Uab, Ubc, and Uca)

Line voltage (Uab, Ubc, and Uca)

Phase voltage (Ua, Ub, and Uc)

Phase voltage (Ua, Ub, and Uc)

Frequency HZ

Frequency HZ

Phase Sequence

Phase Sequence

Load

Current IA, IB, IC

Active power kW

Reactive power kvar

Apparent power kVA

Power factor PF

Generator accumulated energy kWh

Output percentage with load %

— Mains have functions of over/under voltage and loss of phase; Gens have functions of over/under voltage, over/under frequency, over current and over power;

— Precision measure and display of parameters about engine,

Temp. (WT), °C/ °F

Oil pressure (OP), kPa/psi/bar

Fuel level (FL), % Fuel remains L

Speed (SPD), r/min

Battery Voltage (VB), V

Charger Voltage (VD), V

Accumulative running hours

Accumulative start times

— Control protection: Automatic start/stop of diesel genset, close/open (ATS control) and perfect failure display and protection;

— With ETS, idle speed control, pre-heat control, speed droop/raising control, all of them are relay output;

— Parameter setting: Allow user to modify setting and store them in internal EEPROM memory. The parameters cannot be lost even when power off. All of parameters can be set not only from the front panel, but also use USB interface (or RS485 interface) to adjust them via PC.;

— Multi sensors of temperature, pressure and fuel level can be used directly, parameters can be defined by user;

— Multi conditions of crank disconnect (speed, oil pressure, frequency) can be selected;

— With emergency start function;

— With flywheel teeth numbers automatic identification function;

— Power supply range: (8~35)VDC, accommodating to different starting battery volts;

— Connect to cloud server through 4G Wi-Fi;

— With SMS function, alarm information can be sent by the set 5 phone numbers, and can control the genset and inquire the genset status by SMS;

— With GPS positioning function to obtain the genset position to realize the positioning of genset;

— Applied JSON format network data communication protocol to realize upload when genset data changes, the compression algorithm is adopted at the same time, significantly reduces the network

- flow, and the alarm data can be uploaded to server immediately;
- With maintenance function. Types (date or running time) can be selected and actions (warning or alarm shutdown) can be set when maintenance time out;
 - Event log, real-time clock, scheduled start & stop pump unit (can be set as start pump unit once a day/week/month whether with load or not);
 - Add rubber gasket between shell and controller screen, the waterproof can reach IP65;
 - Controller is fixed by metal fixing clips;
 - Modular design, flame-retardant ABS shell, embedded mounting, compact structure and easy installation.

3 SPECIFICATION











Table 2 – Technical Parameters

Items	Contents
Working Voltage	DC8.0V to DC35.0V, continuous power supply
Power Consumption	<5W(Standby mode: ≤3W)
AC System 3P4W 3P3W 1P2W 2P3W	AC15V - AC360 V (ph-N) AC30V - AC620 V (ph-ph) AC15V - AC360 V (ph-N) AC15V - AC360 V (ph-N)
AC Alternator Frequency	50Hz/60Hz
Rotate speed sensor Voltage	1.0V to 24V (RMS)
Rotate speed sensor Frequency	10,000 Hz (max.)
Start Relay Output	16A DC28V at supply voltage
Fuel Relay Output	16A DC28V at supply voltage
Auxiliary Relay Output 1	7A DC28V at supply voltage
Auxiliary Relay Output 2	7A AC250V volt-free output
Auxiliary Relay Output 3	16A AC250V volt-free output
Auxiliary Relay Output 4	16A AC250V volt-free output
Overall Dimensions	209mm x 167mm x 45mm
Panel Cutout	186mm x 141mm
C.T. Secondary Current	5A (rated)
Working Condition	Temperature: (-25~+70)°C; Relative Humidity: (20~93)%RH
Storage Condition	Temperature: (-30~+80)°C
Protection Level	IP65: when water-proof gasket installed between control panel and enclosure.
Insulation Intensity	Apply AC2.2kV voltage between high voltage terminal and low voltage terminal. The leakage current is not more than 3mA within 1min.
Weight	0.91kg

4 OPERATION

4.1 KEYS DSCRIPTION

Table 3 – Keys Description

Icon	Function	Description
	Stop/ Reset	Can stop genset under Manual/Auto mode; Can reset shutdown alarm; Press this key at least 3 seconds to test panel indicators are OK or not (lamp test); During shutdown process, press this key again and can stop genset immediately.
	Start	Start genset under Manual mode, during starting process, press this key can transfer to next status;
	Manual	Pressing this key will set the module as Manual mode.
	Auto	Pressing this key will set the module as Auto mode.
	Gens Close/Open	Can control gens to switch on or off in Manual mode. Note: the key is fit for HGM6120N-4G series controllers.
	Close	Can control gens to switch on in Manual mode. Note: the key is fit for HGM6110N-4G series controllers.
	Open	Can control gens to switch off in Manual mode. Note: the key is fit for HGM6110N-4G series controllers.
	Set/ Confirm	Press this key to enter menu interface; Shift cursor to confirm In parameters setting menu.
	Up/Increase	Screen scroll; Up cursor and increase value in setting menu.
	Down/Decrease	Scroll screen; Down cursor and decrease value in setting menu.
	Home/Return	Return to homepage when in main interface; Exit when in parameters setting interface.

4.2 CONTROLLER PANEL



Fig.1 - HGM6110-4G(HGM6110N-4G/CAN-4G) Front Panel Indication



Fig.2 - HGM6120-4G(HGM6120N-4G/CAN-4G) Front Panel Indication

Note: Partial indicator states:

Alarm Lamp: It will slowly flash when warning alarms; fast flash when shutdown alarms; won't illuminate when there is no alarm.

Status Lamp: It won't illuminate when genset is at rest; flashes 1 time per second in start or stop process and always illuminates during normal running; for HGM6100CAN-4G, press start key in auto mode or manual mode, ECU power will output and status lamp will always illuminate.



: No SIM card or SIM card has poor contact.



: SIM card is correctly installed and the communication is normal, cloud service is failed.

: The controller is connected with cloud monitoring successfully.

: Positioning is failed.

: GPS positioning is successful.

4.3 AUTOMATIC START/STOP OPERATION

Auto mode is activated by pressing the , LED indicator beside the key is illuminating which confirms this action.









Starting Sequence

- 1) HGM6120-4G: When mains is abnormal (over/under voltage, loss of phase), enter into "Mains Abnormal Delay" and LCD displays count-down time. When delay is over, "Start Delay" begins.
- 2) HGM6110-4G: when "remote start" input is active, enter into "Start Delay".
- 3) "Count- down" of start delay is displayed in LCD.
- 4) When start delay is over, preheat relay is outputting (if configured), "Preheat Delay XX s" is displayed in LCD.
- 5) When preheat delay is over, fuel relay is outputting for 1s and then start relay outputs; if genset fails to start during "Crank Time", the fuel and start relay stop outputting and enter into "Crank Rest Time" and wait for next cranking.
- 6) If genset fails to start within set start times, the fifth line of LED will turn black and fail to start alarm will be displayed.
- 7) Any time to start genset successfully, it will enter into "Safe Running". During this period, alarms of low oil pressure, high temperature, under speed, failed to charge and aux. input (be configured) are disabled. As soon as this delay is over, genset will enter into "Start Idle Delay" (if configured).
- 8) During start idle delay, alarms of under speed, under frequency, under voltage are disabled. As soon as this delay is over, genset will enter into "Warming up Delay" (if configured).
- 9) When "Warming up Delay" is over, the indicator is illuminating if gens normal. If voltage and frequency of generator reach the load requirement, close relay outputs, genset is taking load and indicator illuminates; if genset voltage or frequency is abnormal, controller will alarm and shutdown (LCD displays the alarm information).



Stopping Sequence

- 1) HGM6120-4G: during normal running, if mains restore to normal, genset will enter into "Mains Normal Delay", when mains indicator illuminates, "Stop Delay" begins.
- 2) HGM6110-4G: genset enters into "Stop Delay" as soon as "Remote Start" is inactive.
- 3) When "Stop Delay" is over, genset enters into "Cooling Delay". Closing relay is disconnected. After switch "Transfer Rest Delay", closing relay is outputting, mains is taking load, generator indicator extinguishes while mains indicator illuminates.
- 4) When entering "Stop Idle Delay", idle relay is energized to output. (If configured).
- 5) When entering "ETS Delay", ETS relay is energized to output, fuel relay output is disconnected.
- 6) When entering "Genset at Rest", genset will automatically judge if it has stopped.
- 7) When genset stops, then enters into standby mode; if genset fails to stop, controller will alarm ("Fail to Stop" alarm will be displayed in LCD).

4.4 MANUAL START/STOP OPERATION

- 1) **HGM6120-4G**, Manual Mode is active when press  and its indicator illuminates. Under both of the modes, press  to start genset, it can automatically detect crank disconnect and accelerate to high speed running. If there is high temperature, low oil pressure, over speed and abnormal voltage during genset running, controller can protect genset and stop (detail procedures please refer to No.4~9 of Auto start operation). Under Manual Mode, switch won't transfer automatically, it is necessary to press   to transfer load.
- 2) **HGM6110-4G**, Manual Mode is active when pressing , and its indicator is illuminating. Then press  to start genset, it can automatically detect crank disconnect and accelerate to high speed running. If the high temperature, low oil pressure, over speed and abnormal voltage occur during running, controller can protect genset and stop quickly (detail procedures please refer to No.4~9 of Auto start operation). After genset runs normally in high speed, press  and gens take load.
- 3) Manual stop, pressing  can shut down the running genset (detail procedures please refer to No.3~7 of Auto stop operation).

4.5 EMERGENCY START

In manual mode, pressing  and  can force genset to start. The controller won't judge whether the controller has started successfully according to disconnect conditions and the disconnection of starter needs to be controlled by operators. When operators observed the genset has started successfully, then loose the keys and the crank disconnect will stop outputting, the controller will enter into safety delay.

5 PROTECTION

5.1 WARNINGS

When controller detects the warning signal, the genset only alarms but not to stop. The alarms are displayed in LCD.

Table 4 – Controller Warning Alarms

No.	Items	Description
1	Loss Of Speed Signal	When the speed of genset is 0 and speed loss delay is 0, controller will send warning alarm signal and it will be displayed in LCD.
2	Genset Over Current	When the current of genset is higher than threshold and setting over current delay is 0, controller will send warning alarm signal and it will be



No.	Items	Description
		displayed in LCD.
3	Fail To Stop	When genset cannot stop after the "stop delay" is over, controller will send warning alarm signal and it will be displayed in LCD.
4	Low Fuel Level	When the fuel level of genset is lower than threshold or low fuel level warning is active, controller will send warning alarm signal and it will be displayed in LCD.
5	Failed To Charge	During genset normal running process, when the voltage difference between B+ and the charger D+ (WL) is above the Failed To Charge voltage difference for 5s, the controller shall issue Failed To Charge warning, while at the same time LCD displays Failed To Charge warning.
6	Battery Under Voltage	When the battery voltage of genset is lower than threshold, controller will send warning alarm signal and it will be displayed in LCD.
7	Battery Over Voltage	When the battery voltage of genset is higher than threshold, controller will send warning alarm signal and it will be displayed in LCD.
8	Low Coolant Level	When low coolant level input is active, controller will send warning alarm signal and it will be displayed in LCD.
9	Temp. Sensor Open	When sensor hasn't connected to corresponding port, controller will send warning alarm signal and it will be displayed in LCD.
10	Oil Pressure Sensor Open	When sensor hasn't connected to corresponding port, controller will send warning alarm signal and it will be displayed in LCD.
11	Maintenance Warning Due	Maintenance type is running time, when genset running time is longer than maintenance time of user setting, or maintenance type is date, the current date is longer than the set date and maintenance action is set as warning, controller will send warning alarm signal and it will be displayed in LCD.
12	High Temp.	When the water/cylinder temperature of genset is higher than threshold and Enabled High Temp. Stop Inhibited or Input High Temp. Stop Inhibited is active, controller will send warning alarm signal and it will be displayed in LCD.
13	Low Oil Pressure	When the oil pressure of genset is less than threshold and Enabled Low Oil Pressure Stop Inhibited or Input Low Oil Pressure Stop Inhibited is active, controller will send warning alarm signal and it will be displayed in LCD.
14	Input Warn	When external input is active, controller will send warning alarm signal and it will be displayed in LCD.
15	Failed To Charge	When Failed To Charge input is active, controller will send warning alarm

No.	Items	Description
		signal and it will be displayed in LCD.
16	Over Power	when the controller detects that the power value (power is positive) is greater than the pre-set value and the action select "Warn", it will initiate a warning alarm.
17	ECU Warn	If an error message is received from ECU via J1939, it will initiate a warning alarm.
18	GSM Communication Failure	When SGE01-4G (4G Wi-Fi communication expand card) enables, and the GSM module is not be detected, it will initiate a warning alarm.

5.2 SHUTDOWN ALARMS

When controller detects shutdown alarm, it will send signal to open switch and stop genset. The alarms are displayed in LCD.

Table 5 – Shutdown Alarms

No.	Items	Description
1	Emergency Stop	When controller detects emergency stop signal, it will send a stop alarm signal and it will be displayed in LCD.
2	High Temp. Shutdown	When the temperature of water/cylinder is higher than set threshold, controller will send a stop alarm signal and it will be displayed in LCD.
3	Low Oil Pressure Shutdown	When oil pressure is lower than threshold, controller will send a stop alarm signal and it will be displayed in LCD.
4	Over Speed Shutdown	When genset speed is higher than set threshold, controller will send a stop alarm signal and it will be displayed in LCD.
5	Under Speed Shutdown	When genset speed is lower than set threshold, controller will send a stop alarm signal and it will be displayed in LCD.
6	Loss Of Speed Signal Shutdown	When rotate speed is 0 and delay is not 0, controller will send a stop alarm signal and it will be displayed in LCD.
7	Genset Over Voltage Shutdown	When genset voltage is higher than threshold, controller will send a stop alarm signal and it will be displayed in LCD.
8	Genset Under Voltage Shutdown	When genset voltage is under set threshold, controller will send a stop alarm signal and it will be displayed in LCD.
9	Genset Over Current Shutdown	When genset current is higher than set threshold and delay is not 0, it will send a stop alarm signal and it will be displayed in LCD.
10	Failed To Start	Within set start times, if failed to start, controller will send a stop alarm signal and it will be displayed in LCD.
11	Over Freq. Shutdown	When genset frequency is higher than set threshold, controller will send a stop alarm signal and it will be displayed in LCD.
12	Under Freq. Shutdown	When genset frequency is lower than set threshold, controller will send a



No.	Items	Description
		stop alarm signal and it will be displayed in LCD.
13	Genset Failed	When genset frequency is 0, controller will send a stop alarm signal and it will be displayed in LCD.
14	Low Fuel Level	When fuel level low input is active, controller will send a stop alarm signal and it will be displayed in LCD.
15	Low Coolant Level	When genset coolant level low input is active, controller will send a stop alarm signal and it will be displayed in LCD.
16	Temp. Sensor Open	When sensor hasn't connected to corresponding port, controller will send shutdown alarm signal and it will be displayed in LCD.
17	Oil Sensor Open	When sensor hasn't connected to corresponding port, controller will send shutdown alarm signal and it will be displayed in LCD.
18	Maintenance shutdown	When genset running is longer than maintenance time of user setting, and maintenance action is set as shutdown, controller send shutdown alarm signal and it will be displayed in LCD. When maintenance action type is set as "Not used", maintenance alarm reset.
19	Input Shutdown	When external input is active, controller will send shutdown alarm signal and it will be displayed in LCD.
20	Over Power	If over power detection is enabled, when the controller detects that the over power value (power is positive) has exceeded the pre-set value and the action select "Shutdown", it will initiate a shutdown alarm.
21	ECU Shutdown	If an error message is received from ECU via J1939, it will initiate a shutdown alarm.
22	ECU Communication Fail	If the module does not detect the ECU data, it will initiate a shutdown alarm.
23	Over Current Fault Shutdown	When over current fault shutdown input is active, controller will send shutdown alarm signal and it will be displayed in LCD.
24	Over Speed Shutdown Input Alarm	When over speed shutdown input is active, controller will send shutdown alarm signal and it will be displayed in LCD.

Note: ECU warning and Shutdown alarm explains that check genset according to displayed alarm contents; otherwise check engine user manual according to SPN alarm code for gaining information.

6 CONNECTIONS

Compared with HGM6120-4G, HGM6110-4G doesn't have 3-phase input terminal of mains voltage. The back panel of HGM6120-4G is as below.

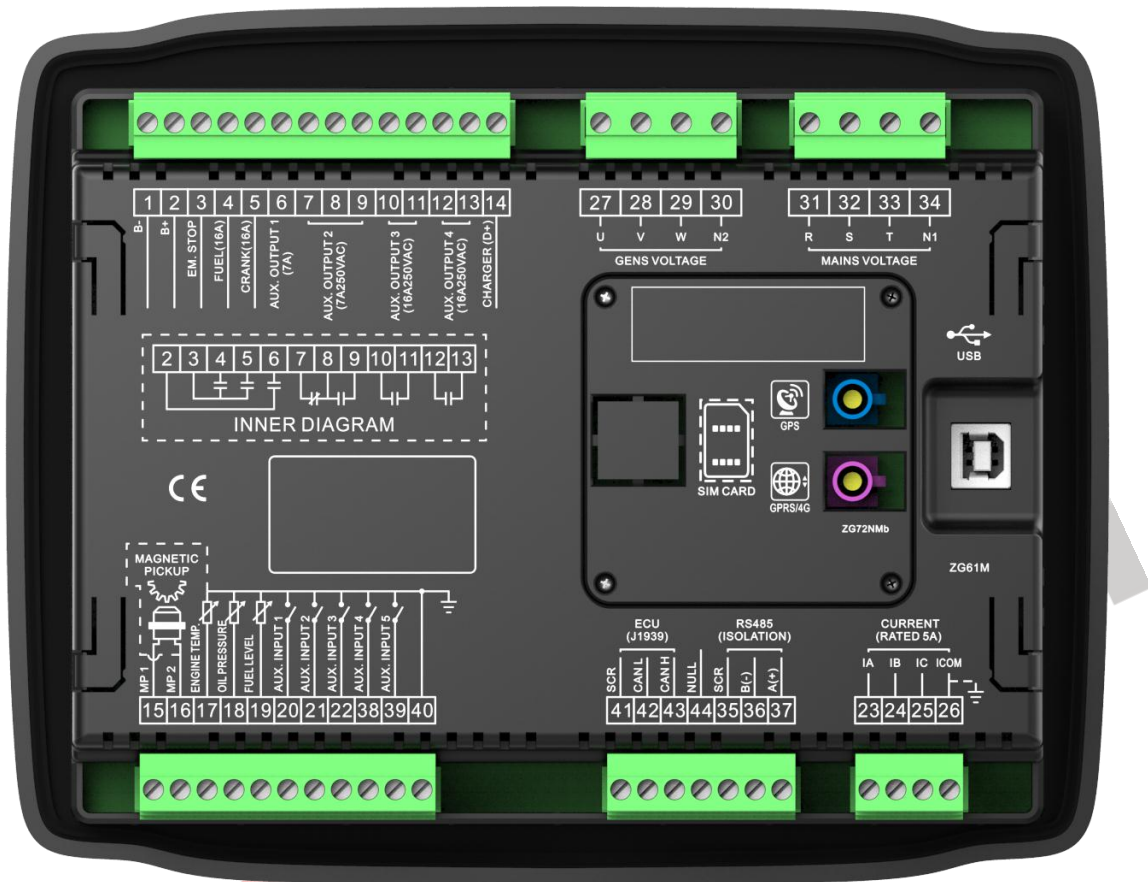

Fig.3 – Controller Rear Panel Drawing

Table 6 – Terminal Connection Description

No.	Function	Cable Size	Description
1	DC input B-	2.5mm ²	Connected to negative of starter battery
2	DC input B+	2.5mm ²	Connected to positive of starter battery. If wire length is over 30m, better to double wires in parallel. Max. 20A fuse is recommended.
3	Emergency Stop	2.5mm ²	Connected to B+ via emergency stop button.
4	Fuel Relay Output	2.5mm ²	B+ is supplied by 3 points, rated 16A
5	Start Relay Output	2.5mm ²	B+ is supplied by 3 points, rated 16A Connect to starter coil
6	Aux. Relay Output 1	1.5mm ²	B+ is supplied by 2 points, rated 7A
7			Normal close output, 7 A rated.
8	Aux. Relay Output 2	1.5 mm ²	Relay common port
9			Normal open output, 7 A rated.
10	Aux. Relay Output 3	2.5mm ²	Relay normal open volt-free contact output
11			
12	Aux. Relay Output 4	2.5mm ²	16 A rated
13			

See Table 8

No.	Function	Cable Size	Description
14	Charging Generator D+ Input	1.0mm ²	Connect to D+ (WL) terminal. If without, the terminal is not connected.
15	Speed sensor input	1.0mm ²	Connected to speed sensor, shielding line is recommended.
16	Speed sensor input, B- is connected.		
17	Temp. Sensor Input	1.0mm ²	Connect to water /cylinder temp. resistance type sensor
18	Oil Pressure Sensor Input	1.0mm ²	Connect to oil pressure resistance type sensor
19	Liquid Level Sensor Input	1.0mm ²	Connect to liquid level resistance type sensor
20	Configurable Input 1	1.0mm ²	Ground connected is active (B-)
21	Configurable Input 2	1.0mm ²	Ground connected is active (B-)
22	Configurable Input 3	1.0mm ²	Ground connected is active (B-)
23	CT A Phase Sensing Input	1.5mm ²	Connect secondary coil, rated 5A
24	CT B Phase Sensing Input	1.5mm ²	Connect secondary coil, rated 5A
25	CT C Phase Sensing Input	1.5mm ²	Connect secondary coil, rated 5A
26	CT Common Port	1.5mm ²	Refer to INSTALLATION description.
27	Generator U phase Voltage Sensing Input	1.0mm ²	Connect to U phase output(2A fuse is recommended)
28	Generator V phase Voltage sensing Input	1.0mm ²	Connect to V phase output(2A fuse is recommended)
29	Generator W phase Voltage Sensing Input	1.0mm ²	Connect to W phase output(2A fuse is recommended)
30	Generator N2 Input	1.0mm ²	Connect to generator N-wire
31	Mains R phase Voltage Sensing Input	1.0mm ²	Connect to mains R phase(2A fuse is recommended) (HGM6110-4G without)
32	Mains S phase Voltage Sensing Input	1.0mm ²	Connect to mains S phase (2A fuse is recommended) (HGM6110-4G without.)
33	Mains T phase Voltage Sensing Input	1.0mm ²	Connect to mains T phase (2A fuse is recommended) (HGM6110-4G without)
34	Mains N1 Input	1.0mm ²	Connect to mains N-wire, (HGM6110-4G without)
35	RS485 Common Ground	/	Impedance-120Ω shielding wire is recommended, its single-end connect with ground.
36	RS485 -	0.5mm ²	
37	RS485+	0.5mm ²	
38	Configurable Input 4	1.0mm ²	Ground connected is active (B-)
39	Configurable Input 5	1.0mm ²	Ground connected is active (B-)
40	Sensor Common	1.0mm ²	Sensor common port
41	CAN COM	0.5mm ²	Impedance-120Ω shielding wire is recommended, its single-end connect with ground (the controller without CANBUS function doesn't have this terminal).
42	CAN L	0.5mm ²	
43	CAN H	0.5mm ²	
44	NULL		

Note: USB ports in controller rear panel are programmable parameter ports; user can directly program via PC.

7 PARAMETER RANGE AND DEFINITION

7.1 PARAMETER CONTENT AND RANGE TABLE

Table 7 – Parameter Content and Range

No.	Items	Range	Default	Description
1	Mains Normal Delay	(0-3600)s	10	The delay from abnormal to normal or from normal to abnormal. It used for ATS (automatic transfer switch) control.
2	Mains Abnormal Delay	(0-3600)s	5	
3	Mains Under Voltage	(30-60000)V	184	When mains voltage is under the point, mains under voltage active. When the value is 30, mains under voltage disabled. Return difference is 10V.
4	Mains Over Voltage	(30-60000)V	276	When mains voltage is greater than the point, mains over voltage active. When the point is 60000V, mains over voltage disabled. Return difference is 10V.
5	Transfer Delay	(0-99.9)s	1.0	It's the delay from mains open to generator closed or from generator open to mains closed.
6(1)	Start Delay	(0-3600)s	1	Time from mains abnormal or remote start signal is active to start genset.
7(2)	Stop Delay	(0-3600)s	1	Time from mains normal or remote start signal is inactive to genset stop.
8(3)	Start Times	(1-10) times	3	When engine start failure, it's the maximum cranking times. When setting crank times out, controller send start fail signal.
9(4)	Preheat Delay	(0-300)s	0	Time of pre-powering heat plug before starter is powered up.
10(5)	Cranking Time	(3-60)s	8	Time of starter power up each time.
11(6)	Crank Rest Time	(3-60)s	10	The second waiting time before power up when engine start fail.
12(7)	Safety On Time	(1-60)s	10	Alarm for low oil pressure, high temp, under speed, under frequency /voltage, Failed To Charge are all inactive.
13(8)	Start Idle Time	(0-3600)s	0	Idle running time of genset when starting.
14(9)	Warming Up Time	(0-3600)s	10	Warming time between genset switch on and high speed running.
15(10)	Cooling Time	(3-3600)s	10	Time for cooling before stopping.
16(11)	Stop Idle Time	(0-3600)s	0	Idle running time when genset stop.
17(12)	ETS Solenoid Hold	(0-120)s	20	Stop electromagnet's power on time when genset is stopping.



No.	Items	Range	Default	Description
18(13)	Fail to Stop Delay	(0-120)s	0	If "ETS Solenoid Hold" set as 0, it is the time from end of idle delay to gen-set at rest; if not 0, it is from end of ETS solenoid delay to gen-set at rest.
19(14)	Switch Close Time	(0.0-10.0)s	5.0	Mains' or generator's switch closing pulse width, when it is 0, output is continuous.
20(15)	Flywheel Teeth	(10.0-300.0)	118	Number of flywheel teeth, it can detect disconnection conditions and engine speed.
21(16)	Gen Abnormal Delay	(0-20.0)s	10.0	Over or under volt alarm delay
22(17)	Gen Over Voltage shutdown	(30-60000)V	264	When genset voltage is over the point, generator over voltage is active. When the point is 60000V, generator over voltage is disabled.
23(18)	Gen Under Voltage Shutdown	(30-60000)V	196	When generator voltage is under the point, generator under voltage is active. When the point is 30V, generator under voltage is disabled.
24(19)	Gen Under Speed shutdown	(0-6000)r/min	1200	When the engine speed is under the point for 10s, shutdown alarm signal is sent out.
25(20)	Gen Over Speed Shutdown	(0-6000)r/min	1710	When the engine speed is over the point for 2s, shutdown alarm signal is sent.
26(21)	Gen Under Frequency Shutdown	(0-75.0)Hz	45.0	When generator frequency is lower than the point (not equal to 0) for 10s, shutdown alarm signal is sent.
27(22)	Gen Over Frequency Shutdown	(0-75.0)Hz	57.0	When generator's frequency is over the point and continues for 2s, generator over frequency is active.
28(23)	High Temperature Stop	(80-300)°C	98	When engine temperature sensor value is over this point, it sends out high temp. alarm. When the value is 300, warning alarm won't be sent. (only suited for temperature sensor, except for high temp. pressure alarm signal inputted by programmable input port)
29(24)	Low Oil Pressure Shutdown	(0-400)kPa	103	When engine oil pressure sensor value is under this point, Low Oil Pressure alarm is sending out. When the value is 0, warning alarm won't be sent. (only suited for oil pressure sensor, except for low oil pressure alarm signal inputted by programmable input port)



No.	Items	Range	Default	Description	
30(25)	Low Fuel Level Warning Value	(0-100)%	10	When fuel level sensor value under this point and remains for 10s, genset send out warning alarm, only warn but not shutdown.	
31(26)	Loss Of Speed Signal Delay	(0-20.0)s	5.0	When the delay setting as 0s, it only warn but not shutdown.	
32(27)	Charge Alternator Fail	(0-30)V	6.0	During genset normal running, when B+ and charger D+ (WL) voltage difference is above this value for 5s, the controller issues Failed To Charge warning.	
33(28)	Battery Over Voltage	(12-40)V	33.0	When generator battery voltage is over the point and remains for 20s, battery over voltage signal is active. it only warn but not shutdown.	
34(29)	Battery Voltage Under	(4-30)V	8.0	When generator battery voltage is under the point and remains for 20s, battery under voltage signal is active. it only warn but not shutdown.	
35(30)	CT Ratio	(5-6000)/5	500	Current transformer ratio.	
36(31)	Full Load Rating	(5-6000)A	500	Rated current of generator, used for calculating over load current.	
37(32)	Over Current Percentage	(50-130)%	120	When load current is over the point, the over current delay is initiated.	
38(33)	Over Current Delay	(0-3600)s	30	When load current is over the point, over current signal is sent. When the delay is 0, only warn but not shutdown.	
39(34)	Fuel Pump On	(0-100)%	25	When the fuel level lower than the set value for 2s, send a signal to open fuel pump.	
40(35)	Fuel Pump Off	(0-100)%	80	When the fuel level higher than the set value for 2s, send a signal to close fuel pump.	
41(36)	Relay Output 1	(0-26)	2	Factory default: Energized to stop. See Table 8	HGM6100N parameter range (0~25)
42(37)	Relay Output 2	(0-26)	3	Factory default: Idle control. See Table 8	
43(38)	Relay Output 3	(0-26)	5	Factory default: Gens closed. See Table 8	
44(39)	Relay Output 4	(0-26)	6	Factory default: Mains closed. See Table 8	
45(40)	Digital Input 1	(0-25)	1	Factory default: High temperature alarm. See Table 9	
46(41)	Active Type	(0-1)	0	Factory default: close	
47(42)	Delay	(0-20.0)s	2.0		

No.	Items	Range	Default	Description
48(43)	Digital Input 2	(0-25)	2	Factory default: Low oil pressure alarm. See Table 9
49(44)	Active Type	(0-1)	0	Factory default: close
50(45)	Delay	(0-20.0)s	2.0	
51(46)	Digital Input 3	(0-25)	10	Factory default: Remote start input. See Table 9
52(47)	Active Type	(0-1)	0	Factory default: close
53(48)	Delay	(0-20.0)s	2.0	
54(49)	Digital Input 4	(0-25)	11	Factory default: Low fuel level warn. See Table 9
55(50)	Active Type	(0-1)	0	Factory default: close
56(51)	Delay	(0-20.0)s	2.0	
57(52)	Digital Input 5	(0-25)	12	Factory default: Low coolant level warn. See Table 9
58(53)	Active Type	(0-1)	0	Factory default: close
59(54)	Delay	(0-20.0)s	2.0	
60(55)	Power On Mode	(0-2)	0	0: Stop Mode; 1: Manual Mode; 2: Auto Mode
61(56)	Module Address	(1-254)	1	The address of controller.
62(57)	Password	(0-9999)	0318	See Note 4
63(58)	Crank Disconnect Condition	(0-6)	2	Conditions of disconnecting starter (generator, magnetic pickup sensor, oil pressure), Each condition can be used alone and simultaneously to separating the start motor and genset as soon as possible.
64(59)	Engine Speed of Crank Disconnect	(0-3000)r/min	360	When engine speed is over this point, starter will disconnect.
65(60)	Frequency of Crank Disconnect	(0.0-30.0)Hz	14.0	When generator frequency is over this point, starter will disconnect.
66(61)	Oil Pressure of Crank Disconnect	(0-400)kPa	200	When engine oil pressure is over this point, starter will disconnect.
67(62)	High Temp. Stop Inhibit	(0-1)	0	Default: when temperature is too high, the genset will alarm and shutdown. Note 2
68(63)	Low OP Inhibit Stop Inhibit	(0-1)	0	Default: when oil pressure is too low, the genset will alarm and shutdown. Note 3
69(64)	AC System	(0-3)	0	0: 3P4W 1: 2P3W 2: 1P2W 3: 3P3W
70(65)	Temp. Sensor Curve Type	(0-14)	8	SGX See Table 10
71(66)	Pressure Sensor Curve Type	(0-14)	8	SGX See Table 10
72(67)	Fuel Level Sensor Curve Type	(0-7)	3	SGD See Table 10



No.	Items	Range	Default	Description
73(68)	Generator Poles	(2-64)	4	Number of magnetic poles, used for calculating rotating speed of generator without speed sensor.
74(69)	Temp. Sensor Open Circuit Action	(0-2)	1	0: Not used; 1: Warning; 2: Shutdown
75(70)	Oil Pressure Sensor Open Circuit Action	(0-2)	1	
76(71)	Disconnect Oil Pressure Delay	(0-20.0)s	0.0	When disconnect conditions include oil pressure and engine oil pressure is higher than disconnect oil pressure delay, the genset is regarded as start successfully and starter will disconnect.
77(72)	Scheduled Run	(0-1)	0	0:Disabled; 1:Enabled.
78(73)	Scheduled Period	(0-1)	0	Circulate condition: monthly, weekly and daily can be selected. Start time and duration can be set.
79(74)	Auto Start Inhibited	(0-1)	0	0:Disabled; 1:Enabled.
80(75)	Scheduled Period	(0-2)	0	Circulate condition: monthly, weekly and daily can be selected. Don't start time and duration can be set.
81(76)	Over Power Action	(0-2)	0	0 Not used; 1 Warn; 2 Shutdown When power is higher than preset value and duration exceeds than delay, over power warning is active. Return and delay value can be set.
82(77)	Start Interface	(0-1)	0	0:Disabled; 1:Enabled. Start interface delay can be set.
83(78)	Maintenance Password	(0-9999)	0	Enter password interface of maintenance configuration.
84(79)	Date/Time	Set the date/time of controller.		
85(80)	Fuel Output Time	(1-60)s	1	It is the time of the genset fuel output during power on.
86(81)	Manual Mode ATS	(0-1)	0	0: Key Switch; 1: Auto Switch.
87(82)	Speed Raise Pulse	(0-20.0)s	0.2	It is the speed-up pulse output time, when the unit enters the high-speed warm-up.
88(83)	Speed Drop Pulse	(0-20.0)s	0.2	It is the speed-drop pulse output time, when the unit enters the stop idling.
89(84)	Fuel Level Low Shutdown	(0-100)%	5	When fuel level of external level sensor falls below the setting limit and lasts for 5s, low fuel shutdown alarm will be initiated; if limit value set as 0, low fuel shutdown alarm will not be initiated.
90(85)	ATS Open Time	(1.0-60.0)s	3.0	



No.	Items	Range	Default	Description
91(86)	Gen PT Ratio	(0-1)	0	0: Disabled; 1: Enabled. PT primary and PT secondary can be set.
92	Mains PT Ratio	(0-1)	0	0: Disabled; 1: Enabled. PT primary and PT secondary can be set. HGM6110N-4G is reserved and without this settings.
93(87)	Active Power Loading Percentage	(0-1)	0	0: Disabled; 1: Enabled. When it is enabled, it is active power/rated power*100; when it is disabled, it is average current of the 3 phases/rated current*100;
94(88)	User-defined Sensor Curve Type	(0-2)	0	0 User-defined temperature sensor 1 User-defined pressure sensor 2 User-defined level sensor Choose sensor which need to be set, input every point (8 points need to be input) resistance and corresponding value(or current, voltage) of curve.
95(89)	Engine Type	(0-39)	0	0: Conventional Genset
96(90)	SPN Alarm Version	(0-3)	0	SPN alarm version
97(91)	Charger Voltage Sampling Option	(0-1)	0	0: Controller 1: ECU
98(92)	Speed Sampling Option	(0-1)	0	0: Controller 1: ECU
99(93)	Temperature Sampling Option	(0-1)	0	0: Controller 1: ECU
100(94)	Oil Pressure Sampling Option	(0-1)	0	0: Controller 1: ECU
101(95)	4G Setting	(0-1)	1	0: Disable 1: Enable

▲Note1: The value in first line of "Number" column is for HGM6120N/CAN-4G and the value in brackets is for HGM6110N/CAN-4G;

▲Note 2: if select high temperature inhibit, or set programmable input as High Temperature Inhibit (this input is active), when temperature is higher than pre-setting threshold, controller sends warning signal only and not shutdown.

▲Note 3: if select low oil pressure inhibit, or set programmable input as Low Oil Pressure Inhibit (this input is active), when low oil pressure is lower than pre-setting threshold, controller sends warning signal only and not shutdown.

▲Note 4: If default password (0318) isn't changed, it doesn't need to input when configuring parameters via PC software; if the password is changed for the first time via PC software, it need to input password in password window.

▲Note 5: Between input correct password and LCD back light haven't got dark, input parameter numbers can enter parameter setting interface when enters "Password Input" again.

▲Note 6: In teeth configuration interface, if being in teeth configuration status and frequency is larger than 20Hz, press start key for auto calculating teeth numbers and press confirm key for changing teeth numbers.

7.2 PROGRAMMABLE OUTPUT 1-4 TABLE

Table 8 – Definition Content of Programmable Output 1-4

No.	Items	Description
0	Not Used	Output is disabled when this item is selected.
1	Common Alarm	Including all shutdown alarm and warning alarm. When a warning alarm occurs, the alarm won't self-lock; When a shutdown alarm occurs, the alarm will self-lock until alarm is reset.
2	Energize to Stop	Used for the genset with stop solenoid. Pick-up when idle speed is over while disconnect when ETS delay is over.
3	Idle Control	Used for the genset with idle speed. Pick-up when crank while disconnect when enter into warming up. Pick-up when stop idle while disconnect when genset stop completely.
4	Preheat Control	Close before started and disconnect before powered on.
5	Close Gen Output	When close time is set as 0, it is continuous closing.
6	Close Mains Output	HGM6110-4G without.
7	Open	When close time is set as 0, Open Breaker is disabled.
8	Speed Rise Relay	Pick-up when enter into warming up time. Disconnect when raise speed auxiliary input active.
9	Speed Drop Relay	Pick-up when enter into stop idle or ETS solenoid stop (shutdown alarm). Disconnect when droop speed auxiliary input active.
10	Run Output	Output when genset is in normal running, disconnect when rotating speed is lower than engine speed after fired.
11	Fuel Pump Control	Pick-up when the fuel level lower than the open threshold or low fuel level warning is active; disconnect when the fuel level over the close threshold and the low fuel level warning input is disabled.
12	High Speed Control	Output when it enters into warming up time, and disconnect after cooling.
13	Auto Mode	The controller is in Auto Mode.
14	Trip and Stop	Output when shutdown alarm occurs and open when alarm resets.
15	Audible Alarm	When shutdown alarm and warn alarm, audible alarm is set as 300s. In audible alarm output duration, when panel any key or "alarm mute" input is active, it can remove the alarm.
16	Heater Control	It is controlled by cooler of temperature sensor's limited threshold.
17	Fuel On	Action when genset is starting and disconnect when stop is completed.
18	Start Output	Genset output in start output status and open in other status.
19	ECU Stop	Used for ECU engine and control its stop.
20	ECU Power Supply	Used for ECU engine and control its power.
21	ECU Warning	Indicate ECU sends a warning signal.
22	ECU Shutdown	Indicate ECU sends a shutdown signal.
23	ECU Communication Failure	Indicate controller not communicates with ECU.



No.	Items	Description
24	Speed Raise Pulse	Raising speed time is output while the unit entering into hi-speed warming up.
25	Speed Drop Pulse	Dropping speed time is output while the unit entering into stop idling.
26	Oil Pump Control	This function only suits for HGM6100CAN-4G with engine type Yuchai-LMB. When unit is standby, pump control output per 30 minutes. If oil pressure is above 100kPa or output delay is more than 1minute, it will stop output; if unit is in re-heating state, oil pump control will always output.
27	Pre-supplied Fuel Output	Outputs 3s before fuel output.
28	ECU Key Switch	Suitable for EFI engine. Ignition switch and ECU power supply are not allowed to supply power at the same time. The normal sequence is that the ECU power supply is supplied first, and the ignition switch delays for 3s.

7.3 PROGRAMMABLE INPUT 1-5 TABLE

Table 9 - Definition Content of Programmable Input 1-5 (Active When Connect To Ground (B-))

No.	Items	Description
0	Not Used	
1	High Temperature Shutdown	If the signal is active after safety run on delay over, genset will immediately alarm to shutdown.
2	Low Oil Pressure Shutdown	
3	Warn Input	Only warning, not shutdown.
4	Shutdown Input	If the signal is active, genset will immediately alarm to shutdown.
5	WTH STOP by Cool	During engine running and the input is active, if high temperature occurs, controller will stop after high speed cooling; when the input is disabled, controller will stop immediately.
6	Generator Closed Auxiliary	Connect to auxiliary port of gen load breaker.
7	Mains Closed Auxiliary	Connect to auxiliary port of mains load breaker. (HGM6100-4G without)
8	Inhibit WTH STOP	When it is active, high oil temperature stop is inhibited. See Note 2 of Parameter Configuration for more information.
9	Inhibit OPL STOP	When it is active, low oil pressure stop is inhibited. See Note 2 of Parameter Configuration for more information.
10	Remote Start	In Auto mode, when input active, genset can be started and with load after genset is OK; when input inactive, genset will stop automatically.
11	Fuel Level Warning	Connected to sensor digital input. The controller sends an warning alarm signal when active.
12	Coolant Level Warning	
13	Fuel Level Shutdown	Connected to sensor digital input. The controller sends an



No.	Items	Description
14	Coolant Level Shutdown	shutdown alarm signal when active.
15	Inhibit Start Auto	In Auto Mode, when the input is active, no matter mains normal or not, genset won't start. If genset is in normal running, stop process won't be executed. When input is disabled, genset will automatically start or stop judging by mains normal or not.
16	Remote Control	All keys in panel is inactive except and Remote Mode is displayed on LCD. Remote module can switch module mode and start/stop operation via panel keys.
17	Charge Alt Fail IN	Connected with charger "Failed to charge".
18	Panel Lock	All keys in panel is inactive except and there is in the left of fifth row in LCD when input is active.
19	Alarm Mute	Can prohibit "Audible Alarm" output when input is active.
20	Idle Control Mode	In this mode, under voltage, under frequency and under speed are not protected.
21	60 Hz Select	It is used for J1939 engine with CANBUS port, when input is active, frequency is 60Hz.
22	Raise Speed Pulse	If engine type is common J1939, when input is active, engine target speed will increase 5RPM.
23	Drop Speed Pulse	If engine type is common J1939, when input is active, engine target speed will decrease 5RPM.
24	IDMT Fault Shutdown	When input is active, controller will initiate shutdown alarms.
25	Mechanical Over Speed	When input is active, controller will initiate shutdown alarms.

7.4 SENSOR SELECTION

Table 10 – Sensor Selection

No.	Items	Content	Description
1	Temperature Sensor	0 Not used 1 User Configured (Resistance Type) 2 VDO 3 SGH 4SGD 5 CURTIS 6 DATCON 7 VOLVO-EC 8 SGX 9 User Configured (4-20mA) 10 User Configured (0-5V) 11 Digital Closed 12 Digital Open 13 Reserved	Defined input resistance range is 0Ω~6000Ω, factory default is SGX sensor.



No.	Items	Content	Description
		14 Reserved	
2	Pressure Sensor	0 Not used 1 User Configured (Resistance Type) 2 VDO 10Bar 3 SGH 4 SGD 5 CURTIS 6 DATCON 10Bar 7 VOLVO-EC 8 SGX 9 User Configured (4-20mA) 10 User Configured (0-5V) 11 Digital Closed 12 Digital Open 13 VDO 5Bar 14 Reserved	Defined input resistance range is 0Ω~6000Ω, factory default is SGX sensor.
3	Fuel Level Sensor	0 Not used 1 User Configured (Resistance Type) 2 SGH 3 SGD 4 User Configured (4-20mA) 5 User Configured (0-5V) 6 Digital Closed 7 Digital Open	Defined input resistance range is 0Ω~6000Ω, factory default is SGD sensor.

▲Note: it needs special instructions for ordering when the genset use 4-20mA or 0-5V sensors.

7.5 CONDITIONS OF CRANK DISCONNECT

Table 11 – Crank Disconnect Conditions

No.	Content
0	Speed
1	Frequency
2	Speed + Frequency
3	Speed + Oil pressure
4	Frequency + Oil pressure
5	Frequency + Speed + Oil pressure
6	Oil pressure

- 1) There are 3 kinds of crank disconnect conditions. Speed, Generator frequency and Oil pressure can be used alone. Oil pressure is used with speed and the generator frequency together is recommended, in order to make the starter and the engine disconnect as soon as possible.
- 2) Speed is the signal measured by magnetic sensor, which is installed in the engine for testing flywheel teeth.

- 3) When choosing speed, ensure the number of flywheel teeth is same as the pre-set, otherwise over or under speed shutdown may appear.
- 4) If generator has no magnetic pickup sensor, don't choose speed item; otherwise Fail to Start or Loss of Speed Signal shutdown will occur.
- 5) If the generator has no oil pressure sensor, don't choose corresponding item.
- 6) If generator frequency has not been selected, controller will not measure and display the relative parameters (can be applied to the pump set); if speed has not been selected, the rotating speed will be calculated by the generating AC signal.

8 4G SETTING

Table 12 – 4G Setting

4G Setting				
1	4G Enable	(0-1)	1	0: Disable; 1: Enable
2	SMS Enable	(0-1)	0	0: Disable; 1: Enable
3	Phone Number	Up to 20	There should be region or country area code for the set number, for China, 86136666666666.	
4	GPRS Enable	(0-1)	1	0: Disable; 1: Enable
5	GPS Enable	(0-1)	1	0: Disable; 1: Enable
6	Longitude	(-180-180)°	113.33	When GPS is disabled, the monitoring module GPS and altitude can be input.
7	latitude	(-90-90)°	34.48	
8	Altitude	(-9999.9-9999.9)m	100	
Cloud Service Setting				
1	Site Name	20 Chinese characters, 40 letters or 40 numbers.		
2	Server URL	www.monitoryun.com		
3	Server Port	(0-65535)	91	
4	Module Password	123456		16 characters.

9 SMS ALARM AND REMOTE CONTROL

9.1 SMS ALARM

When controller detects alarm, it will take initiative to send message to the set phone number.

▲NOTE: All the shutdown alarm will take initiative to send message to the set phone number, warning alarm will selectively send message to the set phone number according to the user setting.

9.2 SMS REMOTE CONTROL

The controller will execute corresponding actions and reply the corresponding the execution information when it received the SMS message sent by users. The controller only can execute the SMS message orders set by itself. The specific SMS message is shown as follows:



Table 13 – SMS Message Order List

No.	SMS Command	SMS Reply Information	Description
1	SMS GENSET	GENSET ALARM	When genset stop alarms.
		SYSTEM IN STOP MODE GENSET AT REST	In stop mode, at rest mode.
		SYSTEM IN MANUAL MODE GENSET AT REST	In manual mode, at rest mode.
		SYSTEM IN AUTO MODE GENSET AT REST	In auto mode, at rest status.
		SYSTEM IN STOP MODE GENSET IS RUNNING	In stop mode, the start status.
		SYSTEM IN MANUAL MODE GENSET IS RUNNING	In manual mode, the start status.
		SYSTEM IN AUTO MODE GENSET IS RUNNING	In auto mode, the start status.
2	SMS START	GENSET ALARM	When genset stop alarms.
		STOP MODE NOT START	Start is disabled in stop mode.
		SMS START OK	Start enables in manual mode.
		AUTO MODE NOT START	Start is disabled in auto mode.
3	SMS STOP MODE	SMS STOP OK	Set to stop mode.
4	SMS MANUAL MODE	SMS MANUAL MODE OK	Set to manual mode.
5	SMS AUTO MODE	SMS AUTO MODE OK	Set to auto mode.
6	SMS DETAIL	The replay content can be set by PC.	To obtain the genset details.

▲NOTE: When send a command, the information should be as the table content, and all the letters should be uppercase.

▲NOTE: The detailed contents of SMS DETAIL reply include: working mode, Mains voltage, Gen voltage, load current, Mains frequency, Gen frequency, active power, apparent power, power factor, battery voltage, D+ voltage, water temperature, oil pressure, oil level, speed, accumulative running time, unit status and alarm status.

10 PARAMETER SETTING

After controller powered on, press  to enter into the parameters setting menu:

- 1) Parameters Setting
- 2) Information
- 3) Language
- 4) Event Log
- 5) Maintenance Setting
- 6) ECU DM2

— Parameters Setting

“0318” can set all items in table 7 during inputting password. When default password has been changed, it needs to input the same password with controller for parameter setting via PC software.

If more parameter items need to be set or password is forgotten, such as voltage and current calibration, please contact with the factory.

▲Notes:

- 1) HGM6110-4G, there are no items 1-5 in table 7; programmable output 1-4 have no digital outputs about mains.
- 2) Please modify the parameters in standby mode (crank conditions, auxiliary input and output configuration, multi delays, etc.) otherwise shutdown alarm or other abnormal conditions may appear.
- 3) The over-voltage threshold must be greater than the under-voltage threshold; otherwise over-voltage and under-voltage will occur at the same time.
- 4) The over-speed threshold must be greater than under-speed threshold, otherwise over speed and under speed will occur at the same time.
- 5) Set frequency value (after crank disconnect) as low as possible, in order to disconnect starter quickly.
- 6) Programmable input 1-5 cannot be set as the same items, otherwise it cannot realize correct function; programmable output 1-4 can be set as the same item.
- 7) If need to shut down after cooling, please set any input as “stop after cooling”, then connect this input to ground; or set high temperature stop action as “cooling stop”

— Information

- 1) LCD will display some information of controller, such as software version, issue date.

▲Note: Pressing  will display the status of digital inputs and outputs.

2) Language

User may select display language as Chinese, English, Spanish, Russian, Portuguese, Turkey, Polish and French.

3) LCD contrast ratio adjustment

Press  and  (or  and ) and adjust LCD contrast ratio, which shall make the LCD

characters clearer. Adjustment range is 0-9.

11 SENSOR SETTING

- When choosing sensor, standard of sensor curve will be needed. If temperature sensor is set as SGH (120°C resistor type), sensor curve should be SGH (120°C resistor type); If it is set as SGD (120°C resistor type), sensor curve should be SGD curve.
- If there is difference between standard sensor curve and chosen sensor curve, select “defined sensor”, and then input defined sensor curve.
- When sensor curve is inputted, X value (resistance) must be in accordance with the order of higher to lower, otherwise errors will occur.
- When sensor is selected as “Not used”, temperature, pressure and fuel level will be display as “ - - - ” in LCD.
- If there is no pressure sensor, but only has low pressure alarm switch, then you must set pressure sensor as “Not used”, otherwise oil pressure low alarm shutdown may appear.
- Can set several points of forehead or backmost as the same ordinate, as the following picture:

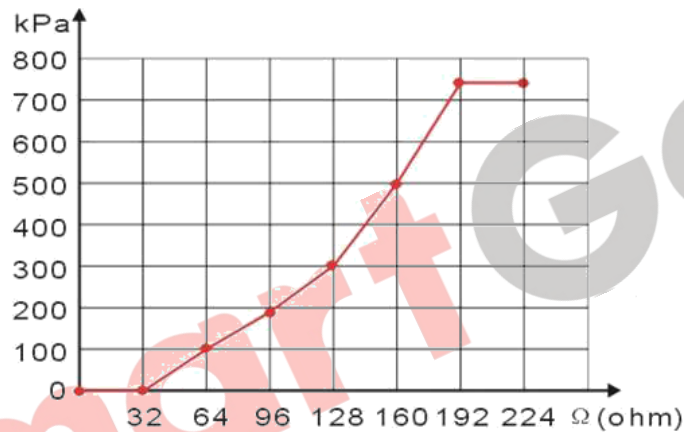

Fig.4 Sensor Curve Diagram

Table 14 - Conventional pressure unit conversion table

	1N/m ² (pa)	1kgf/cm ²	1bar	(1b/in ²) psi
1Pa	1	1.02x10 ⁻⁵	1x10 ⁻⁵	1.45x10 ⁻⁴
1kgf/cm ²	9.8x10 ⁴	1	0.98	14.2
1bar	1x10 ⁵	1.02	1	14.5
1psi	6.89x10 ³	7.03x10 ⁻²	6.89x10 ⁻²	1

12 COMMISSIONING

Before operation, the following checking should be carried out:

- Check and ensure all the connections are correct and wires diameter is suitable.
- Ensure that the controller DC power has fuse; battery positive and negative have correctly connected.
- Emergence stop input must be connected to positive of starting battery via normally close contact of emergency stop.
- Take proper actions to prevent engine to disconnect crank (e. g. Remove the connections of fuel value). If checking is OK, connect start battery, select Manual Mode, controller will execute the program.
- Set controller as Manual Mode, press “start” button to start genset. If failed within the setting crank times, controller will send “Failed to Start” signal; then press “stop” to reset controller.
- Recover actions of preventing engine to disconnect crank (e. g. Connect wire of fuel value), press “start” button again, genset will start. If everything goes well, genset will normal run after idle running (if configured). During this period, watch for engine’s running situations and voltage and frequency of alternator. If there is abnormal, stop genset and check all connections according to this manual.
- Select the Auto Mode from front panel, connect to mains signal. After the mains normal delay, controller will transfer ATS (if configured) into mains load. After cooling, controller will stop genset and into standby state until mains abnormal again.
- When mains abnormal again, genset will start automatically and into normal running, send signal to make gens close, transfer ATS and make genset take load. If it not likes this, please check connections of ATS according to this manual.
- If there are any other questions, please contact SmartGen’s service.

13 TYPICAL APPLICATION

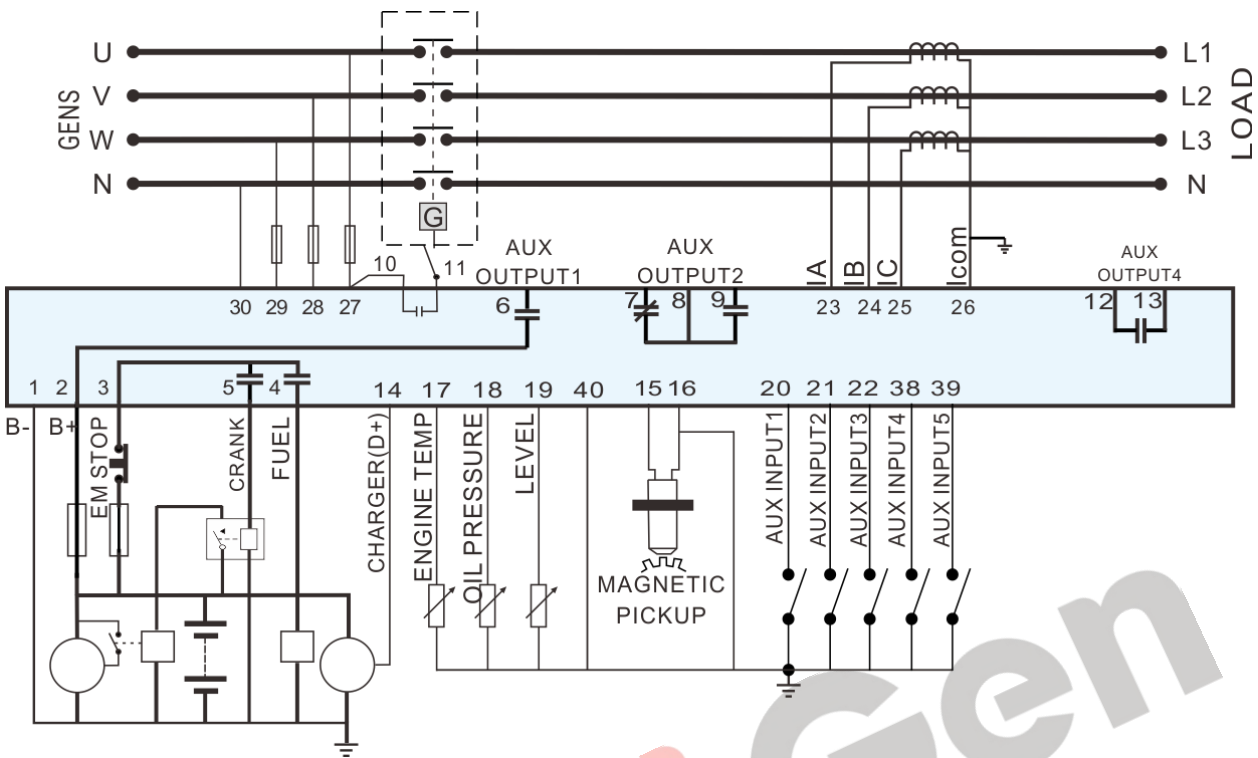

Fig.5 - HGM6110N-4G Typical Application Diagram

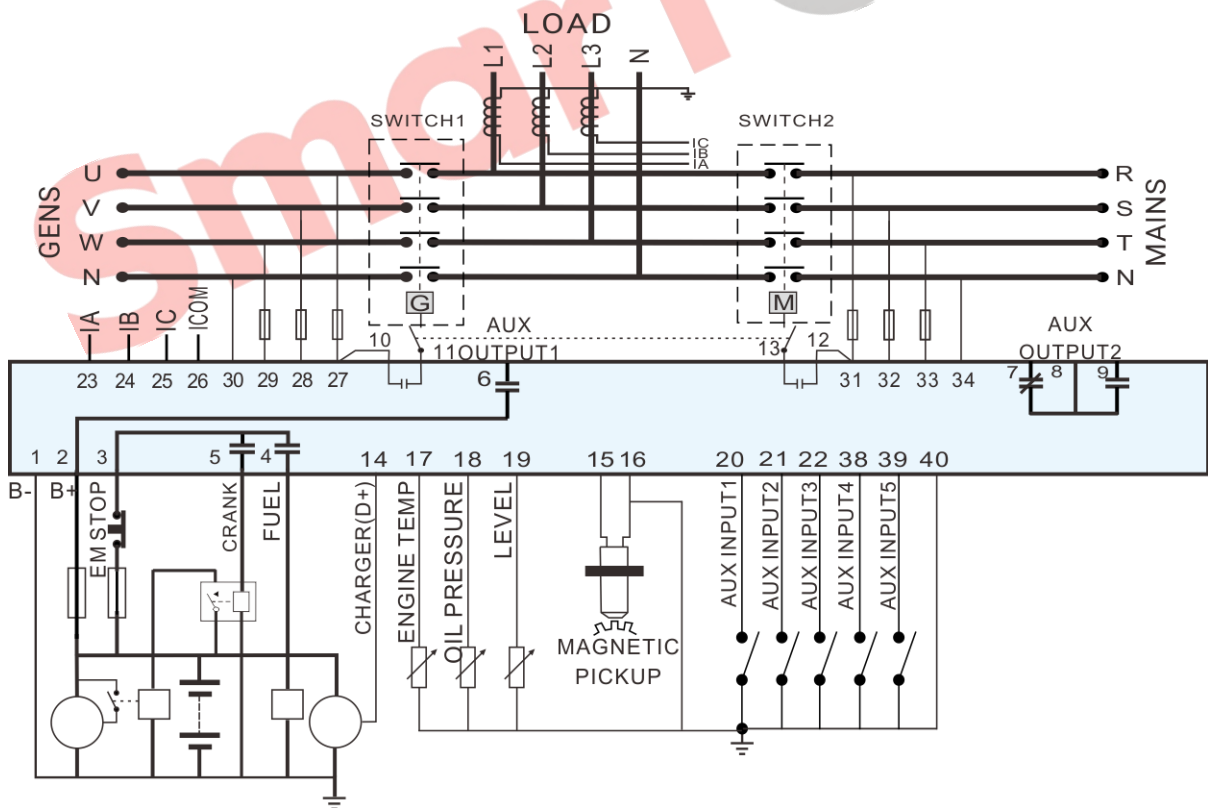

Fig.6 - HGM6120N-4G Typical Application Diagram

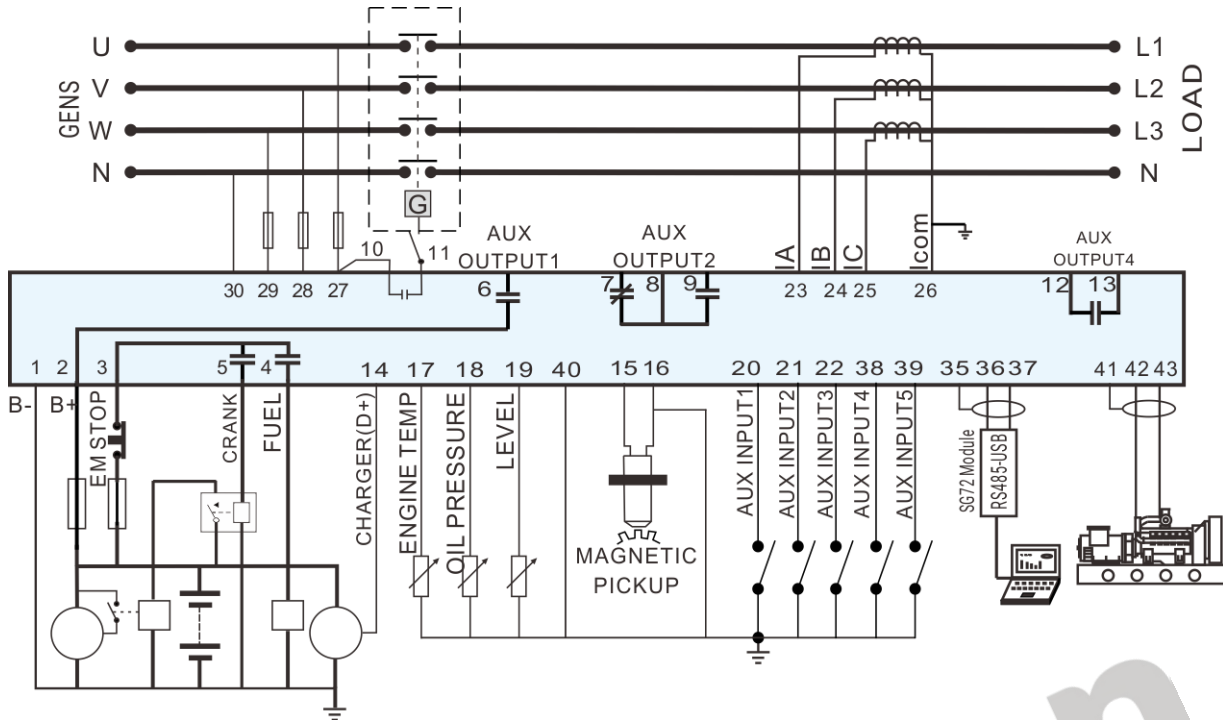

Fig. 7 - HGM6110CAN-4G Typical Application Diagram

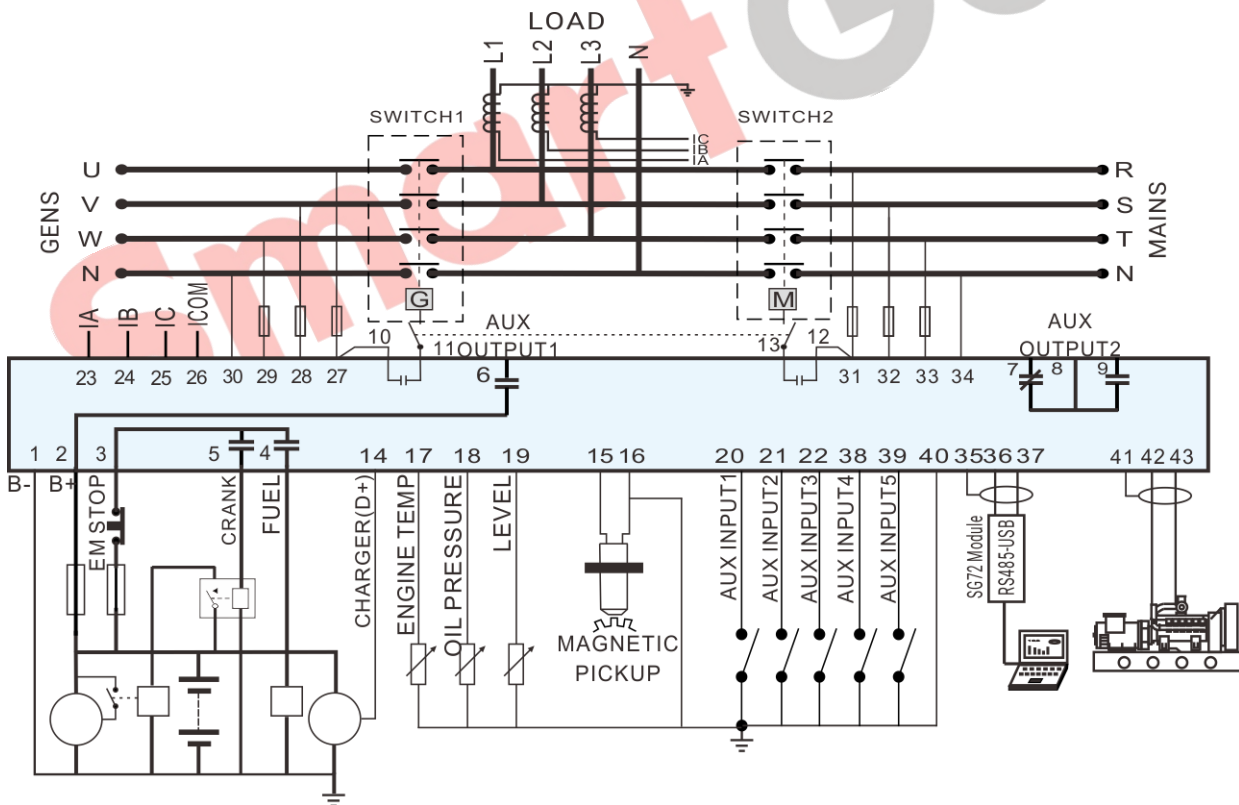

Fig. 8 - HGM6120CAN-4G Typical Application Diagram

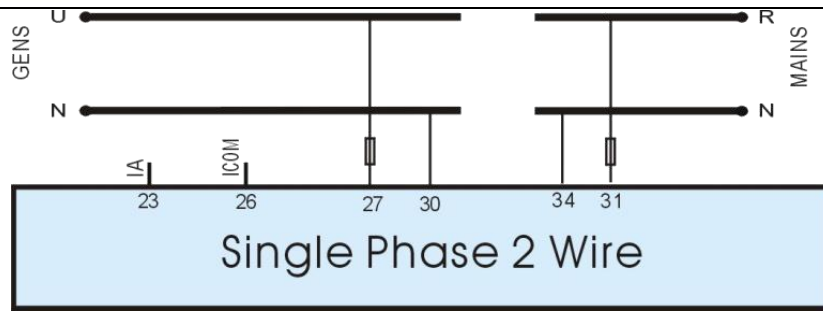

Fig. 9 - Single Phase 2 Wire

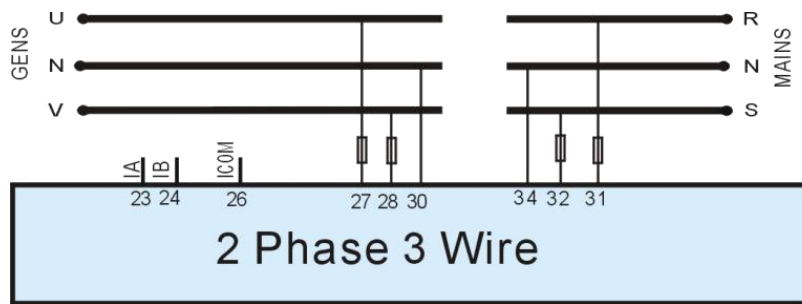

Fig. 10 - 2 Phase 3 Wire

▲Note: Recommend that the output of crank and Fuel expand high capacity relay.

14 INSTALLATION

14.1 ANTENNA AND SIM CARD INSTALLATION

14.1.1 4G ANTENNA PORT

Connect 4G antenna to the 4G port of the controller.

Antenna port: 50Ω/SMA socket

14.1.2 GPS ANTENNA PORT

Enable GPS function, connect GPS antenna to the GPS port of controller.

▲NOTE: GPS antenna should be placed outdoors, otherwise the position is inaccurate or the position cannot be obtained.

50Ω/SMA socket, active antenna.

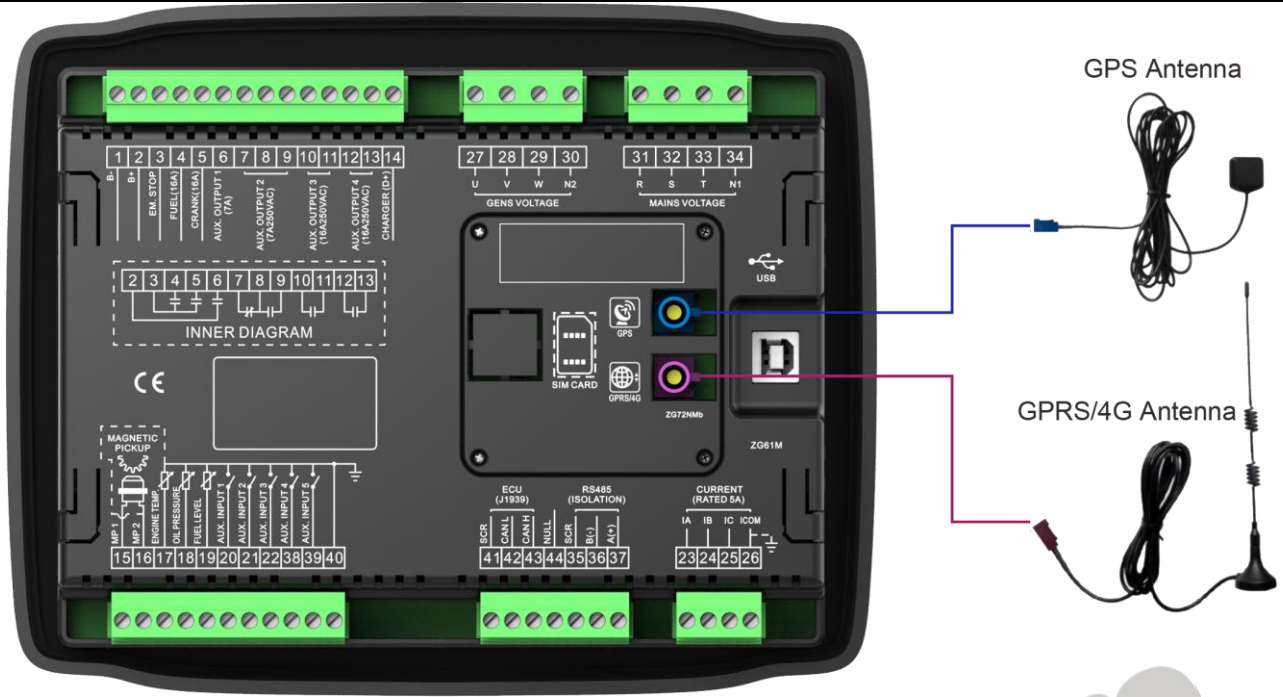



Fig. 11 – HGM6120-4G Antenna Connection Diagram

14.1.3 SIM CARD INSTALLATION

Insert the 4G SIM card, it will connect to the server via Wi-Fi mobile network.

Note: This module supports Netcom 4G Wi-Fi network (the SMS function does not support Telecom 4G card. Standard SIM card (Size:25mm×15mm);

The controller displays , indicating that the SIM card has not been inserted or the SIM card has poor contact.

14.2 FIXING CLIPS (TORQUE)

The module is held into the panel fascia using the supplied fixing clips.

- Withdraw the fixing clip screw (turn anticlockwise) until it reaches proper position.
- Pull the fixing clip backwards (towards the back of the module) ensuring four clips are inside their allotted slots.
- Turn the fixing clip screws clockwise until they make contact with the panel.
- Care should be taken not to over tighten the screws of fixing clips.
- Torque: 2.75kgf*cm(0.27N*m)

14.3 OVERALL DIMENSION AND PANEL CUTOUT

Unit: mm

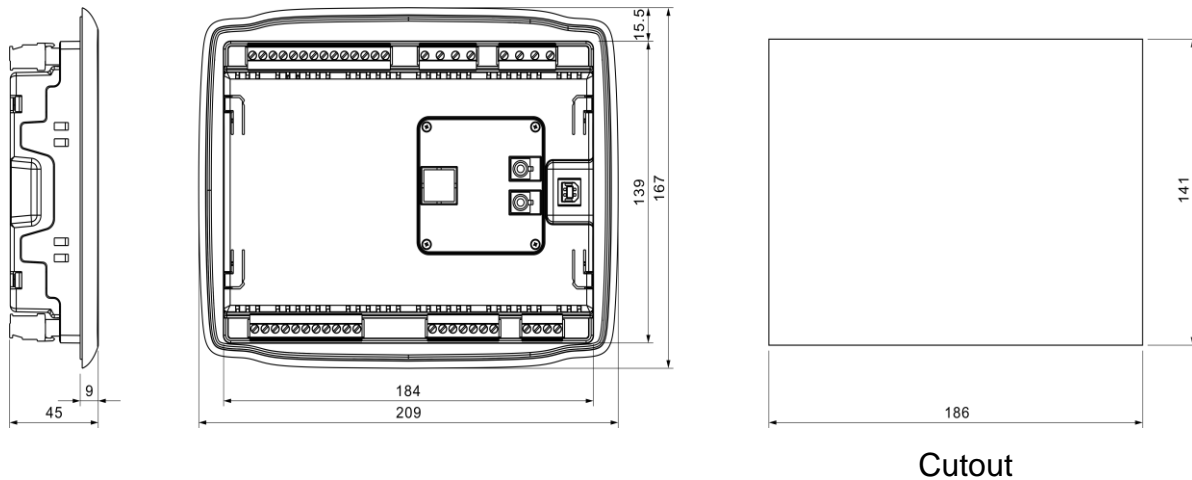

Fig.12 – Case and Overall Dimensions (Unit: mm)

HGM6110N-4G series controller can be applicable to (8~35) VDC battery voltage. Battery negative must be reliably connected to engine shell. The connection between controller power and battery should not be less than 2.5mm². If a float charger is fitted, please connect output line of the charger with battery directly, and then connect battery positive and negative to power input of controller separately, in case that charger will interfere with the normal running of controller.

1) Speed Sensor Input

Speed sensor is installed in the engine for testing flywheel teeth. The connection with controller uses 2-core screen, shield layer should be connected to terminal16 of controller and the other end vacant. The other two signal lines are respectively connected to terminal15 and terminal16. At full speed, output voltage range is (1~24) VAC (RMS), 12VAC is recommended (rated speed). During installing, make the speed sensor contact the flywheel firstly, then pour out 1/3 laps, finally lock nut on the sensor.

2) Output And Expansion Relay

All the outputs of controller are relay output. If need to expand relay, please add freewheeling diode in both ends of relay coil (when expansion relay coil links DC), or add RC loop (when expansion relay coil links AC), in case controller or other equipment are interfered.

3) AC Input

HGM6110N-4G series controller must externally connect to current transformer; CT secondary current must be 5A. Besides, the phase of CT and input voltage must be correct, or the sampling current and active power may be incorrect.

▲Notes: a. Icom must connect to battery cathode of the controller.

b. When there is load current, open circuit is inhibited in the CT secondary side.

5) Dielectric Strength Test

When the controller has been installed in the control panel, during the test please disconnect all the terminals, in case high voltage damages the controller.

15 CONNECTIONS OF CONTROLLER WITH J1939 ENGINE

15.1 CUMMINS ISB/ISBE

Table 15 – Connector B

Terminals of controller	Connector B	Remark
Programmable output port 1	39	Set configurable output 1 as “Fuel Relay Output”
Start relay output	-	Connect with starter coil directly
Programmable output port 2	Expand 30A relay, battery voltage of 01,07,12,13 is supplied by relay.	ECU power Set configurable output 2 as “ECU power”

Table 16 – 9 Pins Connector

Terminals of controller	9 pins connector	Remark
CAN_SCR	SAE J1939 shield	CAN communication shielding line(connect to ECU terminal only)
CAN(H)	SAE J1939 signal	Using impedance 120Ω connecting line.
CAN(L)	SAE J1939 return	Using impedance 120Ω connecting line.

Engine type: Cummins ISB

15.2 CUMMINS QSL9

Suitable for CM850 engine control mode

Table 17 – 50 Pins Connector

Terminals of controller	50 pins connector	Remark
Programmable output port 1	39	Set configurable output 1 as “Fuel Relay Output”
Start relay output	-	Connect to starter coil directly

Table 18 – 9 Pins Connector

Terminals of controller	9 pins connector	Remark
CAN_SCR	SAE J1939 shield-E	CAN communication shielding line(connect to ECU terminal only)
CAN(H)	SAE J1939 signal-C	Using impedance 120Ω connecting line
CAN(L)	SAE J1939 return-D	Using impedance 120Ω connecting line

Engine type: Cummins-CM850

15.3 CUMMINS QSM11 (IMPORT)

It is suitable for CM570 engine control mode. Engine type is QSM11 G1, QSM11 G2.

Table 19 – C1 Connector

Terminals of controller	C1 connector	Remark
Programmable output1	5&8	Set configurable output 1 as “Fuel Relay Output”. Outside expand relay, when fuel output, making make port 5 and port 8 of C1 be connected
Start relay output	-	Connect to starter coil directly

Table 20 – 3 Pins Data Link Connector

Terminals of controller	3 pins data link connector	Remark
CAN_SCR	C	CAN communication shielding line(connect to ECU terminal only)
CAN(H)	A	Using impedance 120Ω connecting line
CAN(L)	B	Using impedance 120Ω connecting line

Engine type: Cummins ISB

15.4 CUMMINS QSX15-CM570

It is suitable for CM570 engine control module. Engine type is QSX15.

Table 21 – 50 Pins Connector

Terminals of controller	50 pins connector	Remark
Programmable output1	38	Oil spout switch; Set configurable output 1 as “Fuel Relay Output”.
Start relay output	-	Connect to starter coil directly

Table 22 – 9 Pins Connector

Terminals of controller	9 pins connector	Remark
CAN_SCR	SAE J1939 shield-E	CAN communication shielding line(connect to ECU terminal only)
CAN(H)	SAE J1939 signal-C	Using impedance 120Ω connecting line
CAN(L)	SAE J1939 return-D	Using impedance 120Ω connecting line

Engine type: Cummins QSX15-CM570

15.5 CUMMINS GCS-MODBUS

It is suitable for GCS engine control module. Use RS485-MODBUS to read information of engine. Engine types are QSX15, QST30, QSK23 /45/60/78 and so on.

Table 23 – D-SUB Connector 6

Terminals of controller	D-SUB connector 06	Remark
Programmable output1	5&8	Set configurable output 1 as “Fuel Relay Output”. Outside expand relay, when fuel output, connect the port 05 of connector 6 and port 08.
Start relay output	-	Connect to starter coil directly

Table 24 – D-SUB Connector 06

Terminals of controller	D-SUB connector 06	Remark
RS485 GND	20	CAN communication shielding line(connect to ECU terminal only)
RS485+	21	Using impedance 120Ω connecting line
RS485-	18	Using impedance 120Ω connecting line

Engine type: Cummins QSK-MODBUS, Cummins QST-MODBUS, Cummins QSX-MODBUS

15.6 CUMMINS QSM11

Table 25 – Engine OEM Connector

Terminals of controller	OEM connector of engine	Remark
Programmable output1	38	Set configurable output 1 as “Fuel Relay Output”.
Start relay output	-	Connect with starter coil directly
CAN_SCR	-	CAN communication shielding line(connect with controller’s this terminal only)
CAN(H)	46	Using impedance 120Ω connecting line
CAN(L)	37	Using impedance 120Ω connecting line

Engine type: common J1939

15.7 CUMMINS QSZ13

Table 26 – Engine OEM Connector

Terminals of controller	OEM connector of engine	Remark
Programmable output1	45	
Start relay output	-	Connect to starter coil directly
Programmable output 2	16&41	Setting to idle speed control, normally open output. Making 16 connect to 41 during high-speed running of controller via external expansion relay.
Programmable output 3	19&41	Setting to pulse raise speed control, normally open output. Making 19

Terminals of controller	OEM connector of engine	Remark
		connect with 41 for 0.1s during high-speed warming of controller via external expansion relay.
CAN_SCR	-	CAN communication shielding line.
CAN(H)	1	Using impedance 120Ω connecting line
CAN(L)	21	Using impedance 120Ω connecting line

Engine type: Common J1939

15.8DETROIT DIESEL DDEC III / IV

Table 27 – Engine CAN Connector

Terminals of controller	CAN port of engine	Remark
Programmable output1	Expand 30A relay, battery voltage is supplied by relay.	Set configurable output 1 as “Fuel Relay Output”.
Start relay output	-	Connect to starter coil directly
CAN GND	-	CAN communication shielding line
CAN(H)	CAN(H)	Using impedance 120Ω connecting line
CAN(L)	CAN(L)	Using impedance 120Ω connecting line

Engine type: J1939 common used

15.9DEUTZ EMR2

Table 28 – F Connector

Terminals of controller	F connector	Remark
Programmable output1	Expand 30A relay, battery voltage of 14 is supplied by relay. Fuse is 16A.	Set configurable output 1 as “Fuel Relay Output”.
Start relay output	-	Connect to starter coil directly
-	1	Connect to battery negative pole
CAN_SCR	-	CAN communication shielding line
CAN(H)	12	Using impedance 120Ω connecting line
CAN(L)	13	Using impedance 120Ω connecting line

Engine type: VolvoEDC4

15.10 JOHN DEERE

Table 29 – 21 Pins Connector

Terminals of controller	21 pins connector	Remark
Programmable output1	G,J	Set configurable output 1 as “Fuel Relay Output”.
Start relay output	D	
CAN GND	-	CAN communication shielding line
CAN(H)	V	Using impedance 120Ω connecting line
CAN(L)	U	Using impedance 120Ω connecting line

Engine type: John Deere

15.11 MTU MDEC

Suitable for MTU engines, 2000 series, 4000series

Table 30 X1 Connector

Terminals of controller	X1 connector	Remark
Programmable output1	BE1	Set configurable output 1 as “Fuel Relay Output”.
Start relay output	BE9	
CAN GND	E	CAN communication shielding line(connect to one terminal only)
CAN(H)	G	Using impedance 120Ω connecting line
CAN(L)	F	Using impedance 120Ω connecting line

Engine type: MTU-MDEC-303

15.12 MTU ADEC(SMART MODULE)

It is suitable for MTU engine with ADEC (ECU8) and SMART module.

Table 31 – ADEC (X1 port)

Terminals of controller	ADEC (X1port)	Remark
Programmable output1	X1 10	Set configurable output 1 as “Fuel Relay Output”. X1 Terminal 9 Connected to negative of battery
Start relay output	X1 34	X1 Terminal 33 Connected to negative of battery

Table 32 - SMART (X4 port)

Terminals of controller	SMART (X4 port)	Remark
CAN_SCR	X4 3	CAN communication shielding line
CAN(H)	X4 1	Using impedance 120Ω connecting line
CAN(L)	X4 2	Using impedance 120Ω connecting line

Engine type: MTU-ADEC

15.13 MTU ADEC(SAM MODULE)

It is suitable for MTU engine with ADEC (ECU7) and SAM module.

Table 33 – ADEC (X1 port)

Terminals of controller	ADEC (X1port)	Remark
Programmable output1	X1 43	Set configurable output 1 as “Fuel Relay Output”. X1 Terminal 28 Connected to negative of battery
Start relay output	X1 37	X1 Terminal 22 Connected to negative of battery

Table 34 – SAM (X23 port)

Terminals of controller	SAM (X23 port)	Remark
CAN_SCR	X23 3	CAN communication shielding line
CAN(H)	X23 2	Using impedance 120Ω connecting line
CAN(L)	X23 1	Using impedance 120Ω connecting line

Engine type: Common J1939

15.14 PERKINS

It is suitable for ADEM3/ ADEM4 engine control mode. Engine type is 2306, 2506, 1106, and 2806.

Table 35 - Connector

Terminals of controller	Connector	Remark
Programmable output1	1,10,15,33,34	Set configurable output 1 as “Fuel Relay Output”.
Start relay output	-	Connect to starter coil directly
CAN_SCR	-	CAN communication shielding line
CAN(H)	31	Using impedance 120Ω connecting line
CAN(L)	32	Using impedance 120Ω connecting line

Engine type: Perkins

15.15 SCANIA

It is suitable for S6 engine control mode. Engine type is DC9, DC12, and DC16.

Table 36 – B1 Connector

Terminals of controller	B1 connector	Remark
Programmable output1	3	Set configurable output 1 as “Fuel Relay Output”
Start relay output	-	Connect to starter coil directly
CAN_SCR	-	CAN communication shielding line
CAN(H)	9	Using impedance 120Ω connecting line
CAN(L)	10	Using impedance 120Ω connecting line

Engine type: Scania

15.16 VOLVO EDC3

Suitable engine control mode is TAD1240, TAD1241, and TAD1242.

Table 37 – “Stand alone” Connector

Terminals of controller	“Stand alone” connector	Remark
Programmable output1	H	Set configurable output 1 as “Fuel Relay Output”
Start relay output	E	
Configurable output 2	P	ECU power Configurable output 2,“ECU power”

Table 38 – “Data bus” Connector

Terminals of controller	“Data bus” connector	Remark
CAN_SCR	-	CAN communication shielding line
CAN(H)	1	Using impedance 120Ω connecting line
CAN(L)	2	Using impedance 120Ω connecting line

Engine type: Volvo

Note: When this engine type is selected, preheating time should be set to at least 3 seconds.

15.17 VOLVO EDC4

Suitable engine types are TD520, TAD520 (optional), TD720, TAD720 (optional), TAD721, TAD722, and TAD732.

Table 39 - Connector

Terminals of controller	Connector	Remark
Programmable output1	Expanded 30A relay, and relay offers battery voltage to terminal 14.Fuse is 16A	Set configurable output 1 as “Fuel Relay Output”
Start relay output	-	Connect to starter coil directly
	1	Connected to negative of battery
CAN GND	-	CAN communication shielding line
CAN(H)	12	Using impedance 120Ω connecting line
CAN(L)	13	Using impedance 120Ω connecting line

Engine type: VolvoEDC4

15.18 VOLVO-EMS2

Volvo Engine types are TAD734, TAD940, TAD941, TAD1640, TAD1641, and TAD1642.

Table 40 – Engine CAN Port

Terminals of controller	Engine's CAN port	Remark
Programmable output1	6	ECU stop Configurable output 1 "ECU stop"
Programmable output2	5	ECU power Configurable output 2 "ECU power"
	3	Negative power
	4	Positive power
CAN_SCR	-	CAN communication shielding line
CAN(H)	1(Hi)	Using impedance 120Ω connecting line
CAN(L)	2(Lo)	Using impedance 120Ω connecting line

Engine type: Volvo-EMS2

Note: When this engine type is selected, preheating time should be set to at least 3 seconds.

15.19 YUCHAI

It is suitable for BOSCH common rail pump engine.

Table 41 – Engine 42 Pins Port

Terminals of controller	Engine 42 pins port	Remark
Programmable output1	1.40	Set configurable output 1 as "Fuel Relay Output". Connect to engine ignition lock
Start relay output	-	Connect to starter coil directly
CAN_SCR	-	CAN communication shielding line
CAN(H)	1.35	Using impedance 120Ω connecting line
CAN(L)	1.34	Using impedance 120Ω connecting line

Table 42 – Engine 2 Pins Port

Battery	Engine 2 pins	Remark
Battery negative	1	Wire diameter 2.5mm ²
Battery positive	2	Wire diameter 2.5mm ²

Engine type: BOSCH

15.20 WEICHAI

It is suitable for Weichai BOSCH common rail pump engine.

Table 43 – Engine Port

Terminals of controller	Engine port	Remark
Fuel relay output	1.40	Connect to engine ignition lock
Start relay output	1.61	
CAN_SCR	-	CAN communication shielding line
CAN(H)	1.35	Using impedance 120Ω connecting line
CAN(L)	1.34	Using impedance 120Ω connecting line

Engine type: GTSC1

Note: If there is any question of connection between controller and ECU communication, please feel free to contact Smartgen service.

16 FAULT FINDING

Table 44 Fault Finding

Symptoms	Possible Solutions
Controller Inoperative	Check starting battery; Check connections of controller. Check the DC fuse.
Genset Stops	Check if water/cylinder temperature too high. Check alternator voltage. Check the DC fuse.
Emergency Stop	Check if an emergency stop key function is correct; Ensure battery positive is connected to the emergency stop input; Check if connection is open circuit.
Low Oil Pressure Alarm (After Crank Disconnect)	Check oil pressure sensor and connections.
High Water Temp. Alarm (After Crank Disconnect)	Check water temperature sensor and connections.
Shutdown Alarm During Running	Check switch and connections according to information on LCD; Check configurable inputs.
Crank Disconnect Failed	Check connections of fuel solenoid; Check starting battery; Check speed sensor and its connections. Refer to engine manual.
Starter Inoperative	Check connections of starter; Check starting battery.
Genset Running While ATS Not Transfer	Check ATS; Check connections between ATS and controller.
RS485 Failure	Check connections; Check if COM port is correct; Check if A and B of RS485 is connected reversely; Check if PC COM port is damaged; 120Ω resistance between PR485 and AB is Recommended.
4G Communication Failure	Check card installation; Check if card can be used normally; Check if the wiring between controller and 4G module is damaged; Check if the local signal can be used normally.

Table 45 Order Models

Order Models	Country/Region	Frequency Band	Note
HGM6100N-4G SGE01-4G	(Mainland China) Only	FDD-LTE: B1, B3, B5, B8 TDD-LTE: B34,B39, B40, B41 GSM/GPRS: 900/1800 MHz	
HGM6100N-4G-S01 SGE02-4G	Mainland China and Southeast Asia	FDD-LTE: B1/B3/B8 TDD-LTE: B38/B39/B40/B41 TD-SCDMA: B34/B39 WCDMA: B1/B8 EVDO/CDMA: BC0 GSM: 900/1800MHz	
HGM6100N-4G-S02 SGE02-4G-S01	North America	FDD-LTE: B2/B4/B12 WCDMA: B2/B5	
Order Models	Country/Region	Frequency Band	Note
HGM6100N-4G-S03 SGE02-4G-S02	North America	FDD-LTE: B2/B4/B5/B13	
HGM6100N-4G-S04 SGE02-4G-S03	Europe/Africa/South Korea/Thailand/Middle East	FDD-LTE: B1/B3/B5/B7/B8/B20 TDD-LTE: B38/B40/B41 WCDMA: B1/B5/B8 GSM: 900/1800MHz	
HGM6100N-4G-S05 SGE02-4G-S04	South America/Australia/New Zealand	FDD-LTE: B1/B2/B3/B4/B5/B7/B8/B28 TDD-LTE: B40 WCDMA: B1/B2/B5/B8 GSM: 850/900/1800/1900MHz	
HGM6100N-4G-S06 SGE02-4G-S05	Japan	FDD-LTE: B1/B3/B8/B18/B19/B26	