

Smartgen®

HGM7200/HGM7100A Series

Automatic Genset Controller

User Manual



Smartgen Technology



Smartgen Technology Co., Ltd

No.28 Jinsuo Road

Zhengzhou

Henan Province

P. R. China

Tel: 0086-371-67988888/67981888

0086-371-67991553/67992951

0086-371-67981000(overseas)

Fax: 0086-371-67992952

Web: <http://www.smartgen.com.cn>

<http://www.smartgen.cn>

Email: sales@smartgen.cn

All rights reserved. No part of this publication may be reproduced in any material form (including photocopying or storing in any medium by electronic means or other) without the written permission of the copyright holder.

Applications for the copyright holder's written permission to reproduce any part of this publication should be addressed to Smartgen Technology at the address above.

Any reference to trademarked product names used within this publication is owned by their respective companies.



Smartgen Technology reserves the right to change the contents of this document without prior notice.

Software Version

Date	Version	Note
2010-10-15	1.0	Original release
2010-12-15	1.1	Add note about some engine type. Add functions of inputs. Change factory default of liquid level sensor; Correct some errors in selection table of sensors
2011-08-24	1.2	Add the function of "start inhibit".
2011-10-27	1.3	Add input function (Auto Mode Lock and Auto Mode Invalidation).
2012-6-15	1.4	Add custom start per weekly. Add selectivity configuration. Add part of the engine wiring instructions.
2013-02-27	1.5	Add HGM7100A series controller while delete HGM7100 series controller; Modify some functions of HGM7200 series controllers; Modify some functions of "custom period".
2013-04-17	1.6	Modify the contents of "Modules Comparison"

This manual is suitable for HGM7200 and HGM7100A series controller only.

Clarification of notation used within this publication.

SIGN	INSTRUCTION
 NOTE	Highlights an essential element of a procedure to ensure correctness.
 CAUTION!	Indicates a procedure or practice, which, if not strictly observed, could result in damage or destruction of equipment.
 WARNING!	Indicates a procedure or practice, which could result in injury to personnel or loss of life if not followed correctly.

SmartGen

CONTENTS

1	SUMMARY	6
2	ORDER INFORMATION AND MODULES COMPARISON	6
2.1	ORDER INFORMATION	6
2.2	MODULES COMPARISON	7
2.3	MODELS ABBREVIATION.....	7
3	PERFORMANCE AND CHARACTERISTICS	8
4	SPECIFICATION	11
5	OPERATION	12
5.1	INDICATOR LIGHT	12
5.2	KEY FUNCTIONS.....	13
5.3	LCD DISPLAY.....	14
5.3.1	MAIN DISPLAY.....	14
5.3.2	BASIC PARAMETERS SETTING MENU	16
5.3.3	ADVANCED PARAMETERS SETTING MENU	17
5.4	AUTO START/STOP OPERATION	19
5.5	MANUAL START/STOP OPERATION	21
5.6	SWITCH CONTROL PROCEDURES	22
5.6.1	HGM7X20 SWITCH CONTROL PROCEDURES	22
5.6.2	HGM7X10 SWITCH CONTROL PROCEDURES	23
6	PROTECTION	25
6.1	WARNINGS.....	25
6.2	SHUTDOWN ALARM	27
6.3	TRIP AND STOP ALARM.....	29
6.4	TRIP ALARM	30
7	WIRINGS CONNECTION	31
8	SCOPES AND DEFINITIONS OF PROGRAMMABLE PARAMETERS	34
8.1	CONTENTS AND SCOPES OF PARAMETERS	34
8.2	ENABLE DEFINITION OF PROGRAMMABLE OUTPUT PORTS.....	43
8.2.1	DEFINED PERIOD OUTPUT	47
8.2.2	CUSTOM COMBINED OUTPUT	47
8.3	DEFINED CONTENTS OF CONFIGURABLE INPUT PORTS (ALL ACTIVE WHEN CONNECT TO GRAND (B-))	49

8.4	SELECTION OF SENSORS	52
8.5	CONDITIONS OF CRANK DINSCONNECT SELECTION	53
9	PARAMETERS SETTING.....	54
10	SENSORS SETTING	55
11	COMMISSIONING	56
12	TYPICAL APPLICATION	57
13	INSTALLATION	59
14	GSM SHORT MESSAGE ALARM AND REMOTE CONTROL	61
14.1	GSM SHORT MESSAGE ALARM.....	61
14.2	GSM SHORT MESSAGE REMOTE CONTROL	61
15	CONNECTIONS OF CONTROLLER WITH J1939 ENGINE.....	63
15.1	CUMMINS ISB/ISBE.....	63
15.2	CUMMINS QSL9	63
15.3	CUMMINS QSM11 (IMPORT).....	64
15.4	CUMMINS QSX15-CM570	64
15.5	CUMMINS GCS-MOVBUS.....	65
15.6	CUMMINS QSM11.....	65
15.7	CUMMINS QSZ13	66
15.8	DETROIT DIESEL DDEC III / IV.....	66
15.9	DEUTZ EMR2.....	67
15.10	JOHN DEERE.....	67
15.11	MTU MDEC.....	67
15.12	MTU ADEC(SMART MODULE).....	68
15.13	MTU ADEC(SAM MODULE)	68
15.14	PERKINS.....	69
15.15	SCANIA	69
15.16	VOLVO EDC3	70
15.17	VOLVO EDC4	70
15.18	VOLVO-EMS2.....	71
15.19	YUCHAI	71
15.20	WEICHAH	72
16	FAULT FINDING	73

1 SUMMARY

HGM7200/7100A series genset controllers are used for genset automation and monitor control system of single unit to achieve automatic start/stop, data measure, alarm protection and “three remote” (remote control, remote measuring and remote communication). The controller adopts large liquid crystal display (LCD) and selectable Chinese, English or other languages interface with easy and reliable operation.

HGM7200/7100A controller adopts 32 bits micro-processor technology with precision parameters measuring, fixed value adjustment, time setting and threshold adjusting and etc. The majority of parameters can be set using front panel and all the parameters can be set using PC (via USB port) and can be adjusted and monitored with the help of RS485 ports. It can be widely used in a number of automatic genset control system with compact structure, simple connections and high reliability.

2 ORDER INFORMATION AND MODULES COMPARISON

2.1 ORDER INFORMATION

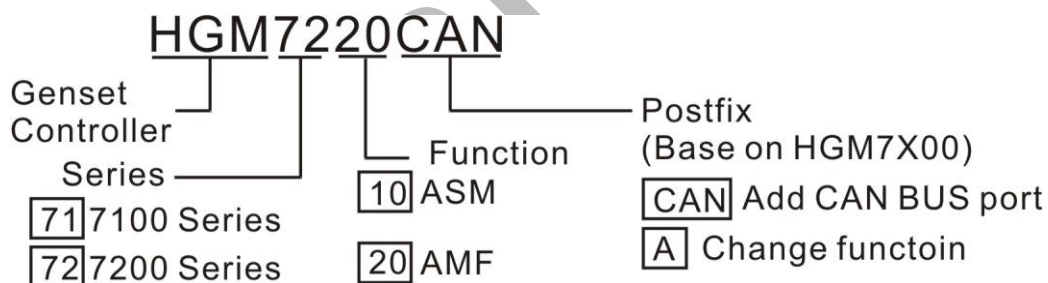

Note:

- (1) It is basic model if without postfix.
- (2) Please contact with our qualified personnel for more information about the postfix descriptions.

2.2 MODULES COMPARISON

Items	HGM 7120A	HGM 7110A	HGM 7220	HGM 7210	HGM 7220CAN	HGM 7210CAN
Input Port	7	7	7	7	7	7
Output port ①	8	8	8	8	8	8
Sensor number ②	5	5	5	5	5	5
AMF	•		•		•	
RS485			•	•	•	•
GSM			•	•	•	•
CAN (J1939)					•	•
USB	•	•	•	•	•	•
Real-time clock	•	•	•	•	•	•
Event log	•	•	•	•	•	•

***Note:**

(1) Two of the outputs are fixed: start output and fuel output.

(2) Analog sensors are composed by 3 fixed sensors (temperature, pressure, fuel level) and 2 configurable sensors.

2.3 MODELS ABBREVIATION

Abbreviation	Description
HGM72X0	All HGM7200 series controllers
HGM71X0A	All HGM7100A series controllers
HGM7X20	All HGM7200/7100A series AMF controllers
HGM7X10	All HGM7200/7100A series ASM controllers

3 PERFORMANCE AND CHARACTERISTICS

HGM7X10, Auto Start Module, controls genset to start or stop automatically by remote start signal.

HGM7X20, Auto Main Failure, updates based on HGM7X10, especially for automatic system composed by generator and mains.

Main characteristics,

- ◆ With ARM-based 32-bit CPU, highly integrated hardware, new reliability level;
- ◆ 132x64 LCD with backlight, multilingual interface (including English, Chinese or other languages) which can be chosen at the site, making commissioning convenient for factory personnel;
- ◆ Improved LCD wear-resistance and scratch resistance due to hard screen acrylic;
- ◆ Silicon panel and pushbuttons for better operation in high-temperature environment;
- ◆ RS485 communication port enabling remote control, remote measuring, remote communication via ModBus protocol (controller with RS485 port only);
- ◆ Equipped with SMS (Short Message Service) function. When genset is alarming, controller can send short messages via SMS automatically to max. 5 telephone numbers. besides, generator status can be controlled and checked using SMS (controller with GSM port only);
- ◆ Equipped with CANBUS port and can communicate with J1939 genset. Not only can you monitoring frequently-used data (such as water temperature, oil pressure, speed, fuel consumption and so on) of ECU machine, but also control starting up, shutdown , raising speed and speed droop via CANBUS port (controller with CAN Bus port only);
- ◆ Suitable for 3-phase 4-wire, 3-phase 3-wire, single phase 2-wire, and 2-phase 3-wire systems with voltage 120/240V and frequency 50/60Hz;
- ◆ Collects and shows 3-phase voltage, current, power parameter and frequency of generator or mains.

Parameters:

Mains	Gens
Line voltage (Uab, Ubc, and Uca)	Line voltage (Uab, Ubc, and Uca)
Phase voltage (Ua, Ub, and Uc)	Phase voltage (Ua, Ub, and Uc)
Phase sequence	Phase sequence
Frequency (Hz)	Frequency (Hz)

Load

Current IA, IB, IC

Each phase and total active power KW

Each phase and total reactive power KVar

Each phase and total apparent power KVA

Each phase and average power factor PF

Accumulate total gens power kWh, kVarh, kVAh

- ◆ For Mains, controller has over and under voltage, over and under frequency, loss of phase and phase sequence wrong detection functions; For generator, controller has over and under voltage, over and under frequency, loss of phase, phase sequence wrong, over and reverse power, over current functions.
- ◆ 3 fixed analog sensors (temperature, oil pressure and liquid level);
- ◆ 2 configurable sensors can be set as sensor of temperature or fuel level;
- ◆ Precision measure and display parameters about Engine,

Temp. (WT)	°C/°F both be display
Oil pressure (OP)	kPa/Psi/Bar all be displayed
Fuel level (FL)	% (unit)
Speed (SPD)	RPM (unit)
Voltage of Battery (VB)	V (unit)
Voltage of Charger (VD)	V (unit)

Hour count (HC) can accumulate Max. 65535 hours.
Start times can accumulate Max. 65535 times
- ◆ Protection: automatic start/stop of the gen-set, ATS(Auto Transfer Switch) control with perfect fault indication and protection function;
- ◆ All output ports are relay-out;
- ◆ Parameter setting: parameters can be modified and stored in internal FLASH memory and cannot be lost even in case of power outage; most of them can be adjusted using front panel of the controller and all of them can be modified using PC via USB or RS485 ports.
- ◆ More kinds of curves of temperature, oil pressure, fuel level can be used directly and users can define the sensor curves by themselves;
- ◆ Multiple crank disconnect conditions (speed sensor, oil pressure, generator frequency) are optional;
- ◆ Widely power supply range DC(8~35)V, suitable to different starting battery voltage environment;

- ◆ Event log and real-time clock.
- ◆ Scheduled start & stop generator (can be set as start genset once a day/week/month whether with load or not; also can be set as customers' wish);
- ◆ Selectivity configuration. Users can choose different configuration by input port.
- ◆ Can be used on pumping units and as an indicating instrument (indicate and alarm are enable only, relay is inhibited);
- ◆ With maintenance function. Actions (warning, shutdown or trip and stop) can be set when maintenance time out;
- ◆ All parameters used digital adjustment, instead of conventional analog modulation with normal potentiometer, more reliability and stability;
- ◆ Waterproof security level IP55 due to rubber seal installed between the controller enclosure and panel fascia;
- ◆ Metal fixing clips enable perfect in high temperature environment;
- ◆ Modular design, anti-flaming ABS plastic enclosure, pluggable connection terminals and embedded installation way; compact structure with easy mounting.

SmartGen

4 SPECIFICATION

Items	Contents
Operating Voltage	DC8.0V to 35.0V, Continuous Power Supply.
Power Consumption	<3W (standby ≤2W)
Alternator Input Range	
3-Phase 4-Wire	15VAC - 360VAC (ph-N)
3-Phase 3-Wire	30VAC - 620VAC (ph-ph)
Single-Phase 2-Wire	15VAC - 360VAC (ph-N)
2-Phase 3-Wire	15VAC - 360VAC (ph-N)
Alternator Frequency	50/60Hz
Speed sensor voltage	1.0V to 24.0V (RMS)
Speed sensor Frequency	10,000 Hz (max.)
Start Relay Output	16 Amp DC28V at supply output
Fuel Relay Output	16 Amp DC28V at supply output
Auxiliary Relay Output (1)	7 Amp DC28V at supply output
Auxiliary Relay Output (2)	7 Amp 250VAC voltage free output
Auxiliary Relay Output (3)	16 Amp 250VAC voltage free output
Auxiliary Relay Output (4)	16 Amp 250VAC voltage free output
Auxiliary Relay Output (5)	7 Amp DC28V at supply output (HGM72X0 only)
Auxiliary Relay Output (6)	7 Amp DC28V at supply output(HGM72X0 only)
Case Dimension	197mm x152mm x47mm
Panel Cutout	186mm x141mm
C.T. Secondary	5A rated
Working Conditions	Temperature: (-25~+70)°C; Humidity: (20~90)%RH
Storage Condition	Temperature: (-30~+80)°C
Protection Level	IP55: when waterproof rubber seal installed between the controller and panel fascia. IP42: when waterproof rubber seal is not installed between the controller and panel fascia.
Insulation Intensity	Object: among in input/output/power Quote standard: IEC688-1992 Test way: AC1.5kV/1min leakage current: 3mA
Net Weight	0.75kg

5 OPERATION

5.1 INDICATOR LIGHT

HGM7X20

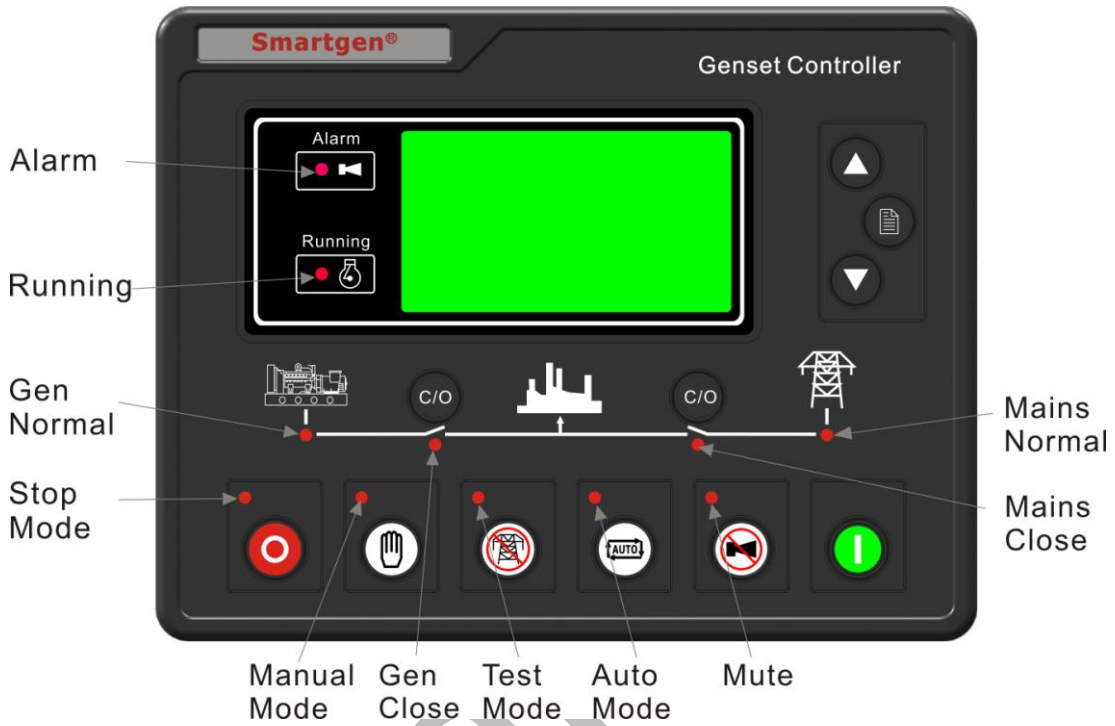

HGM7X10

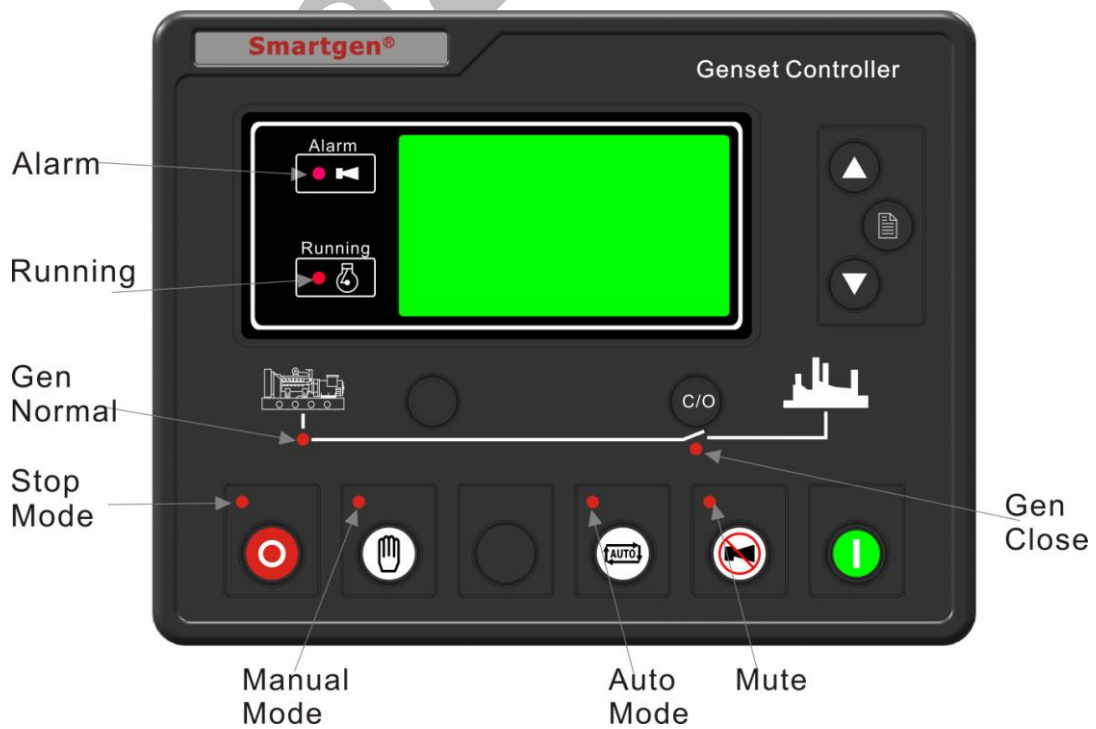

▲NOTE: Selected light indicators description:

Alarm light:











Alarm Type	Status
Warning	Twinkle slowly. (1 time per sec.)
Trip and Not Shutdown	Twinkle slowly. (1 time per sec.)
Shutdown	Twinkle fast. (5 times per sec.)
Trip and Shutdown	Twinkle fast. (5 times per sec.)

Running light: It is light on from crank disconnect to ETS while extinguishing in other period.



Gens normal light: It is light on when gens is normal; It is twinkling when gens is abnormal; It is extinguishing when there is no power.





Mains normal light: It is light on when mains is normal; It is twinkling when mains is abnormal; It is extinguishing when there is no power.

5.2KEY FUNCTIONS

	Stop/Reset	Stop running generator in Auto/Manual mode; Lamp test (press at least 3 seconds); Reset alarm in stop mode; During stopping process, press this button again to stop generator immediately.
	Start	Start genset in Manual mode or Manual Testing mode.
	Manual Mode	Press this key and controller enters in Manual mode.
	Auto Mode	Press this key and controller enters in Auto mode.
	Running With Load	Press this key and controller enters in Manual Testing mode. (HGM7X10 without)
	Mute/Reset Alarm	Alarming sound off; If there is trip alarm, pressing the button at least 3 seconds can reset this alarm.
	Gen Closed/Open	Can control generator to switch on or off in manual mode.
	Mains Closed/Open	Can control mains to switch on or off in manual mode (HGM7X10 without).
	Page Scroll /Confirm	1) Page turning; 2) press it at least 3 seconds to enters in basic parameter setting menu and shift cursor to confirm the set information.
	Up/Increase	1) Screen scroll; 2) Up cursor and increase value in setting menu.
	Down/Decrease	1) Screen scroll; 2) Down cursor and decrease value in setting menu.

▲ NOTE: Press  over 3 seconds, go into basic parameters setting menu.

▲ NOTE: Press  and  simultaneously, enter into advanced parameters setting menu if password is correct.

▲ NOTE: Press  and  simultaneously, increase contrast of LCD while press  and  simultaneously will decrease it. And the contrast of LCD will back to default setting when controller have power again after lost.



WARNING: default password is 00318, user can change it in event of others change the senior parameters setting. Please closely remember it after changing. If you forget it, please contact Smartgen services and send all information in the controller page of “ABOUT”.

5.3 LCD DISPLAY

5.3.1 MAIN DISPLAY

Main display show pages, use  to scroll the pages and   to scroll the screen.

☐ **Status**, including as below,

Status of genset, mains, and ATS

☐ **Engine**, including as below,

Speed, temperature of engine, engine oil pressure, liquid (fuel) level, programmable analog 1, programmable analog 2, battery voltage, charger voltage, accumulated run time, accumulated start times.

▲ NOTE: If connected with J1939 engine via CANBUS port, this page also includes: coolant pressure, coolant level, fuel temperature, oil pressure, inlet temperature, exhaust temperature, turbo pressure, total fuel consumption and so on.(different engine with different parameters)

☐ **Gen**, including as below,

Phase voltage, Line voltage, frequency, phase sequence

☐ **Mains**, including as below

Phase voltage, Line voltage, frequency, phase sequence

▲ NOTE: HGM7X10 has no this page.

▣ **Load**, including as below,

Current, each phase and total active power (positive and negative), each phase and total reactive power (positive and negative), each phase and total apparent power, each phase and average power factor (positive and negative), accumulated energy (kWh, kVarh, kVAh).

▲ **Note:** When only mains switch on indicator lights, count active and reactive power, apparent power, power factor, but accumulate electric energy. Counting the generator active and reactive power, apparent power, power factor, and accumulate electric energy under other conditions.

▲ **NOTE:** Power factor shows as following,

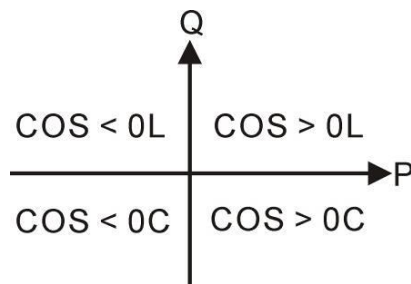

Remark:
P stands for active power
Q stands for inactive power

Power factor	Conditions	Active power	Inactive power	Remark
COS>0L	P>0,Q>0	Input	Input	Load is inductive resistance.
COS>0C	P>0,Q<0	Input	Output	Load is capacitance resistance.
COS<0L	P<0,Q>0	Output	Input	Load as one under excitation generator
COS<0C	P<0,Q<0	Output	Output	Load as one over excitation generator.

▲ **Note:**

1. Input active power, generator or mains supply electricity to load.
2. Output active power, load supply electricity to generator or mains.
3. Input reactive power, generator or mains send reactive power to load.
4. Output reactive power, load send reactive power to generator or mains.

☐ Alarm

▲ NOTE: For ECU alarms and shutdown alarms, if the alarm information is displayed, check engine according to it, otherwise, please check the manual of generator according to SPN alarm code.

☐ Event log

Records all start/stop events (shutdown alarm, trip and stop alarm, manual /auto start or stop) and the real time when alarm occurs.

☐ Others, including,

Time and Date, count down time for maintenance (if it is enable), input/output ports status.

☐ About

Issue time of software and hardware version

Example,

Engine Speed		Voltage	
1500	RPM	L1-N	0V
		L2-N	0V
		L3-N	0V

5.3.2 BASIC PARAMETERS SETTING MENU

Including as following,

- ☐ Conditions of crank disconnect
- ☐ Flywheel teeth
- ☐ Rated speed
- ☐ Gen rated voltage
- ☐ Gen rated frequency
- ☐ Mains rated voltage
- ☐ Mains rated frequency
- ☐ CT ratio
- ☐ Rated current
- ☐ Rated power
- ☐ Battery Voltage
- ☐ Time and date
- ☐ Start delay

- ☐ Stop delay
- ☐ Preheat timer
- ☐ Cranking timer
- ☐ Crank Rest Timer
- ☐ Safety on timer
- ☐ Start idle timer
- ☐ Warming up timer
- ☐ Cooling timer
- ☐ Stop idle timer
- ☐ ETS(Energize to Stop) hold time
- ☐ Wait stop time
- ☐ After stop time

Example,

Basic Parameters	Form 1: Change the items, enter into setting (form2), and exit setting.
Return	
Crank Disconnect	
Flywheel Teeth Rated speed	

Crank Disconnect Setting 1 frequency + speed	Form 2: Enter into setting (Form3), press or to back previous menu, press back to previous menu (form 1).
--	---

Crank Disconnect 1 frequency + speed	Form 3: Change items; confirm setting (form2), exits setting (form2).
---	--

5.3.3 ADVANCED PARAMETERS SETTING MENU

Including,

- ☐ Mains
- ☐ Timers
- ☐ Engine
- ☐ Generator
- ☐ Load
- ☐ ATS
- ☐ Analog Sensor

- ☑ Digital Inputs
- ☑ Digital Outputs
- ☑ Module
- ☑ Scheduled and maintenance
- ☑ GSM (SMS)

Example:





Advanced Parameters >Mains >Status delayed >Engine >Generator	Form1 Change items, enters setting (form2), exits setting.
---	---





Generator >Return >AC system >Poles >Rated voltage	Form 2 Change items (form3), select "return" and press back to previous menu (form1), back to previous menu (form 1).
--	--





Generator >Under Voltage Shutdown > Over Freq Shutdown > Under Freq Shutdown > Over Voltage Warn	Form 3 Change items, confirm setting (form 4), back to previous menu (form 1).
--	---

Over Voltage Warn Sel: Disable Setting value, 00110% Return value : 00108% Delayed time: 00005	Form 4 Go into setting (form5), press or back to previous menu (form3), back to previous menu (form 3).
--	---

Over Voltage Warn Sel: Disable Setting value: 00110% Return value: 00108% Delayed time: 00005	Form 5 Change setting items (form 6), confirm setting (form 7), and exit setting (form4).
---	--

Over Voltage Warn	Form 6
Sel: Enable	
Setting value: 00110%	  Change setting items (form5),  confirm setting (form 7),  and exit setting (form4).
Return value: 00108%	
Delayed time: 00005	

Gen over voltage warn	Form 7
Sel: Enable	
Setting value, 00110%	  Change setting items (form5),  confirm setting,  and exit setting (form4).
Return value, 00108%	
Delayed time, 00005	

Gen over voltage warn	Form 8,
Sel: Disable	
Setting value, 00110%	  Change setting items,  confirm setting (form 4),  and exit setting (form4).
Return value, 00108%	
Delayed time, 00005	

▲ NOTE: Long time pressing  can exit setting directly during setting.

5.4 AUTO START/STOP OPERATION

Press , its indicator lights, and controller enters **Auto** mode.

Starting Sequence,

1. HGM7X20: When Mains is abnormal (over and under voltage, over and under frequency, loss of phase, phase sequence wrong), it enters into mains “abnormal delay” and LCD display count down time. When mains abnormal delay is over, it enter into “start delay”; it also enters into this mode when “remote start on load” is active.
2. HGM7X10: Generator enters into “start delay” as soon as “Remote Start on Load” is active.
3. Start Delay timer is shown on Status page of LCD.
4. When start delay is over, preheat relay outputs (if this be configured), “preheat start delay XX s” is shown in LCD.

5. When preheat delay is over, fuel relay outputs 1s and then start relay output; if engine crank fails during “cranking time”, the fuel relay and start relay deactivated and enter into “crank rest time” to wait for next crank.
6. If engine crank fails within setting times, the controller sends **Fail to Start** signal and Fail To Start message appears on LCD alarm page.
7. In case of successful crank attempt, “safety on timer” starts. During this period, low oil pressure, high water temperature, under speed, charge failure alarms are disabled. As soon as this delay is over, “start idle delay” is initiated (if configured).
8. During “start idle delay”, under speed, under frequency, under voltage alarms are inhibited. When this delay is over, “warming up delay” starts (if configured).
9. When “warming up delay” is over, if generator state is normal, its indicator will be illuminated. If voltage and frequency has reached on-load requirements, the closing relay will be energised, generator will accept load, generator power indicator will turn on, and generator will enter Normal Running state; if voltage and frequency are abnormal, the controller will initiate alarm (alarm type will be displayed on LCD alarm page).







NOTE: In case of “Remote Start (off Load)”, the procedure is the same, except for step NO. 9: the closing relay will NOT be energised, generator will NOT accept load.

Stopping Sequence,

- 1.HGM7X20, when mains return normal during gen-set running, enters into mains voltage “Normal delay”. When mains normal delay are over, enter into “stop delay”; also can be into this mode when “remote start on load” is inactive.
- 2.HGM7X10, generator enters into “stop delay” as soon as “Remote Start on Load” is inactive.
- 3.When stop delay is over, close generator relay is un-energized; generator enters into “cooling time delay”. After “transfer rest time”, close mains relay is energized. Generator indicator extinguish while mains indicator lights.
- 4.Idle relay is energized as soon as entering “stop idle delay”.

- 5.If enter “ETS hold delay”, ETS relay is energized. Fuel relay is deactivated and decides whether generator is stopped or not automatically.
- 6.Then enter gen-set “Fail to stop timer”, auto decides whether generator is stopped or not.
- 7.Enter “after stop time” (if configured) as soon as generator stops. Otherwise, controller will send “Fail to stop” alarm. (If genset stopped successfully after warning of “Failed to Stop”, will enter “after stop time” and remove alarm)
- 8.Enter “generator at rest” as soon as “after stop time” is over.

5.5 MANUAL START/STOP OPERATION

1. HGM7X20: Press , controller enters into Manual starts mode and its indicator lights. Press , then controller enters into “Manual Test Mode” and its indicator lights. In the both mode, press  to start generator, can automatically detect crank disconnected, and generator accelerates to high-speed running. With high temperature, low oil pressure and abnormal voltage during generator running, controller can protect genset to stop quickly (please refer to No.4~9 of Auto start operation for detail procedures). In “Manual Test Mode ”, generator runs well, whether mains normal or not, loading switch must be transferred to generator side. In “manual mode ”, the procedures of ATS please refer to ATS procedure of generator in this manual.
2. HGM7X10: Press , controller enters into Manual starts mode and its indicator lights. Then press  to start generator, can automatically detect crank disconnected, and generator accelerates to high-speed running. With high temperature, low oil pressure and abnormal voltage during generator running, controller can protect genset to stop quickly (please refer to No.4~9 of Auto start operation for detail procedures). After generator runs well, if remote start signal is active, controller will send closing gens signal; if the remote signal is inactive,

controller won't send closing signal.

3. **Manual stop:** press  can shutdown the running generator (please refer to No.3~8 of Stopping Sequence for detail procedures).

5.6 SWITCH CONTROL PROCEDURES

5.6.1 HGM7X20 SWITCH CONTROL PROCEDURES

Manual transfer procedures

When controller is in **Manual** mode, the switch control procedures will start through manual transfer.



Users can control the loading transfer of ATS via pressing button to switch on or off.

A. If “Open breaker detect” is “SELECT Disable”

Press generator switch on or off key , if gens has taken load, will send unload signal; if taken no load, generator will send load signal; if mains has taken load, mains will unload, and then generator will take load.

Press mains switch on or off key , if mains has taken load, will send unload signal; if taken no load, mains will send load signal; if gens has taken load, generator will unload, and then mains will take load.

B. If “Open breaker detect” is “SELECT Enable”

To transfer load from mains to generator need to press mains switch off key  firstly. After switch off delay, press generator switch on key , and generator will take load (there is no action when pressing switch on key directly).

The way to transfer from generator to mains is as the same as above.

Auto transfer procedures:

When controller is in Manual Test, Auto or Stop mode, switch control procedures will start through automatic transfer.

1. If input port is configured as Close Mains Auxiliary

A. If “Open breaker detect” is “SELECT Disable”

When transferring load from mains to generator, controller begins detecting “fail to

transfer”, then the open delay and transfer rest delay will begin. When detecting time out, if switch open failed, the generator will not switch on, otherwise, generator switch on. Detecting transfer failure while gens switch on. When detecting time up, if switch on fail, it is need to wait for generator to switch on. If transfer failed and warning “SELECT Enable”, there is alarming signal whatever switch on or off failure.

The way to transfer from generator load to mains load is as same as above.

B. If “Open breaker detect” is “SELECT Disable”

Mains load is transferred into generator load, after the delay of switch off and transfer interval, generator switch on. Detecting transfer fail while generator switch on. After detecting time up, if switch on fail, then wait for generator switch on. If transfer fail and warning “SEL Enable”, there is alarming signal.

2. If input port is not configured as Close Mains Auxiliary

Mains load be transferred into gens load, after switch off and transfer interval delay, gens switch on.

The way to transfer gens load to mains load is as same as above.

5.6.2 HGM7X10 SWITCH CONTROL PROCEDURES

Manual transfer procedures,

When controller is in Manual mode, manual transfer will be executive.

Users can control switch on or off by pressing key.

Press generator switch on or off key  , if generator have taken load, will output unload signal; if taken no load, generator will output load signal.

Auto control procedures,

When controller is in manual test, auto or stop mode, switch control procedures will start auto transfer.

1.If input port is configured as Close Mains Auxiliary

A.If “Open breaker detect” is “SELECT Disable”

Gens load is transferred into generator un-load, after the delay of switch off, detecting

transfer failure while switch off output. When detecting time up, if switch off failed, to wait for switch off. Otherwise, switch off is completed.

Gens unload is transferred into gens load, after the delay of switch on, detecting transfer failure while switch on outputting. When detecting time up, if switch on failed, to wait for switch on. Otherwise, switch on is completed.

If transfer failed and warning “SEL Enable”, there is alarming signal whatever switch on or off failure.

B.If “Open breaker detect” is “SELECT Enable”

Gens load is transferred into gens unload, after the delay of switch off, switch off is completed.

Gens unload is transferred into gens load, after the delay of switch on, detecting transfer failure while switch on outputting. When detecting time up, if switch on failed, to wait for switch on. Otherwise, switch on is completed.

If transfer failure warning is “SEL Enable”, there is warning signal that “switch on fail”.

2.If input port is not configured as Close Mains Auxiliary

Gens un-load is transferred into gens load, gens switch on and output.

Gens load is transferred into gens un-load, gens switch off and output.

▲NOTE:

When using ATS of no interposition, switch off detecting is “SELECT Disable”;

When using ATS of having interposition, switch off “SELECT Disable” or “SELECT Enable” both are OK. If choose “SELECT Enable”, switch off output should be configured;

When using AC contactor, switch off “SELECT Disable” recommended.

6 PROTECTION

6.1 WARNINGS

When controller detects the warning signal, alarm only and not stop genset.

Warnings as following,

No.	Type	Description
1	Over Speed Warn	When controller detects the speed is higher than the set value, it will send warn signal.
2	Under Speed Warn	When controller detects the speed is lower than the set value, it will send warn signal.
3	Loss of Speed Signal Warn	When controller detects the speed is 0 and the action select "Warn", it will send warn signal.
4	Over Frequency Warn	When controller detects the frequency is higher than the set value, it will send warn signal.
5	Under Frequency Warn	When controller detects the frequency is lower than the set value, it will send warn signal.
6	Over Voltage Warn	When controller detects the voltage is higher than the set value, it will send warn signal.
7	Under Voltage Warn	When controller detects the voltage is lower than the set value, it will send warn signal.
8	Over Current Warn	When controller detects the current is higher than the set value, it will send warn signal.
9	Fail to Stop	When generator not stops after the "stop delay" is over.
10	Charge Alt Fail	When controller detects the charger voltage is lower than the set value, it will send warn signal.
11	Battery Over Voltage	When controller detects the battery voltage is higher than the set value, it will send warn signal.
12	Battery Under Voltage	When controller detects the battery voltage is lower than the set value, it will send warn signal.
13	Maintenance Due	When count down time is 0 and the action select "Warn", it will send warn signal.
14	Reverse Power	When controller detects the reverse power value (power is negative) is lower than the set value, it will send warn signal.
15	Over Power	When controller detects the reverse power value (power is positive) is higher than the set value, it will

No.	Type	Description
		send warn signal.
16	ECU Warn	When controller gets the alarm signal from engine via J1939, it will send warn signal.
17	Gen Loss of Phase	When controller detects the generator loss phase, it will send warn signal.
18	Gen Phase Sequence Wrong	When controller detects the reverse phase, it will send warn signal.
19	Switch Fail Warn	When controller detects the switch on and off fail, and the action select enable, it will send warn signal.
20	Temp. Sensor Open	When controller detects the sensor is open circuit, and the action select "warn", it will send warn signal.
21	High Temp. Warn	When controller detects the temperature is higher than the set value, it will send warn signal.
22	Low Temp. Warn	When controller detects the temperature is lower than the set value, it will send warn signal.
23	Pressure Sensor Open	When controller detects the sensor is open circuit, and the action select "warn", it will send warn signal.
24	Low OP Warn	When controller detects the oil pressure is lower than the set value, it will send warn signal.
25	Level Sensor Open	When controller detects the sensor is open circuit, and the action select "warn", it will send warn signal.
26	Low Level Warn	When controller detects the oil lever is lower than the set value, it will send warn signal.
27	Flexible Sensor 1 Open	When controller detects the sensor is open circuit, and the action select "warn", it will send warn signal.
28	Flexible Sensor 1 High	When controller detects the sensor value is higher than the max. set value, it will send warn signal.
29	Flexible Sensor 1 Low	When controller detects the sensor value is lower than the min. set value, it will send warn signal.
30	Flexible Sensor 2 Open	When controller detects the sensor is open circuit, and the action select "warn", it will send warn signal.
31	Flexible Sensor 2 High	When controller detects the sensor value is higher than the max. set value, it will send warn signal.
32	Flexible Sensor 2 Low	When controller detects the sensor value is lower than the min. set value, it will send warn signal.

No.	Type	Description
33	Digital Input Warn	When digit input port is set as warning and active, controller sends corresponding warning signal.
34	GSM Com Fail	When select GSM enable but the controller couldn't detect GSM model, controller sends corresponding warning signal.

6.2 SHUTDOWN ALARM

When controller detects shutdown alarm, it will send signal to stop the generator.

Shutdown alarms as following,

No.	Type	Description
1	Emergency Stop	When controller detects emergency stop signal, it will send a stop signal.
2	Over Speed	When controller detects the speed value is higher than the set value, it will send a stop signal.
3	Under Speed	When controller detects the speed value is lower than the set value, it will send a stop signal.
4	Loss Of Speed Signal	When controller detects speed value equals to 0, and the action select "Shutdown", it will send a stop alarm signal
5	Over Frequency	When controller detects the frequency value is higher than the set value, it will send a stop signal.
6	Under Frequency	When controller detects the frequency value is lower than the set value, it will send a stop signal.
7	Over Voltage	When controller detects the voltage value is higher than the set value, it will send a stop signal.
8	Under Voltage	When controller detects the voltage value is lower than the set value, it will send a stop signal.
9	Fail To Start	If genset start fail within setting of start times, controller will send a stop signal.
10	Over Current	When controller detects the current value is higher than the set value, it will send a stop signal.
11	Maintenance Due	When count down time is 0 and the action select "Shutsown", it will send a stop alarm signal.
12	ECU shutdown	When controller gets stop signal from engine via J1939, it

No.	Type	Description
		will send a stop signal.
13	ECU Com Fail	When controller NOT gets data from engine via J1939, it will send a stop signal.
14	Reverse Power Shutdown	When controller detects reverse power value (power is negative) is lower than the set value, and the reverse power action select "shutdown", it will send a stop alarm signal.
15	Over Power Shutdown	When controller detects reverse power value (power is positive) is higher than the set value, and the reverse power action select "shutdown", it will send a stop signal.
16	Temp. Sensor Open	When controller detects sensor is open circuit, and the action select "shutdown", it will send a stop signal.
17	High Temp. Shutdown	When controller detects temperature is higher than the set value, it will send a stop signal.
18	Pressure Sensor Open	When controller detects sensor is open circuit, and the action select "shutdown", it will send a stop signal.
19	Low OP Shutdown	When controller detects oil pressure is lower than the set value, it will send a stop signal.
20	Level Sensor Open	When controller detects sensor is open circuit, and the action select "shutdown", it will send a stop signal.
21	Flexible Sensor 1 Open	When controller detects sensor is open circuit, and the action select "shutdown", it will send a stop signal.
22	Flexible Sensor 1 High	When controller detects the sensor value is higher than the max. set value, it will send stop signal.
23	Flexible Sensor 1 Low	When controller detects the sensor value is lower than the min. set value, it will send stop signal.
24	Flexible Sensor 2 Open	When controller detects sensor is open circuit, and the action select "shutdown", it will send a stop signal.
25	Flexible Sensor 2 High	When controller detects the sensor value is higher than the max. set value, it will send stop signal.
26	Flexible Sensor 2 Low	When controller detects the sensor value is lower than the min. set value, it will send stop signal.
27	Digital Input Port	When digital input port is set as shutdown, and the action is active, it will send a shutdown signal.

6.3 TRIP AND STOP ALARM

When controller detects shutdown alarm signal, it will shutdown generator quickly and stop after high speed cooling.

Trip and stop alarm as following,

No.	Type	Description
1	Over Current	When controller detects the value is higher than the set value, and the action select "trip and shutdown", it will send trip and stop signal.
2	Maintenance Due	When count down time is 0 and the action select "trip and shutdown", it will send a trip and stop signal.
3	Reverse Power	When controller detects reverse power value (power is negative) is lower than the set value, and the action select "trip and shutdown", it will send a trip and stop signal.
4	Over Power	When controller detects the over power value (power is positive) is higher than the set value, and the action select "trip and shutdown", it will send a trip and stop signal.
5	Digital Input Ports	When digital input port is set as "trip and shutdown", and the action is active, it will send a trip and stop signal.

6.4 TRIP ALARM

When controller detects trip alarm, it will break close generator signal quickly, but genset not stop.

Trip alarm as following,

No.	Type	Description
1	Over Current	When controller detects the value is higher than the set value, and the action select "trip", it will send trip signal.
2	Reverse Power	When controller detects reverse power value (power is negative) is lower than the set value, and the action select "trip", it will send a trip signal.
3	Over Power	When controller detects the over power value (power is positive) is higher than the set value, and the action select "trip", it will send a trip signal.
4	Digital Input Ports	When digital input port is set as "trip", and the action is active, it will send a trip signal.

7 WIRINGS CONNECTION

HGM7200/7100A controller's rear as following :

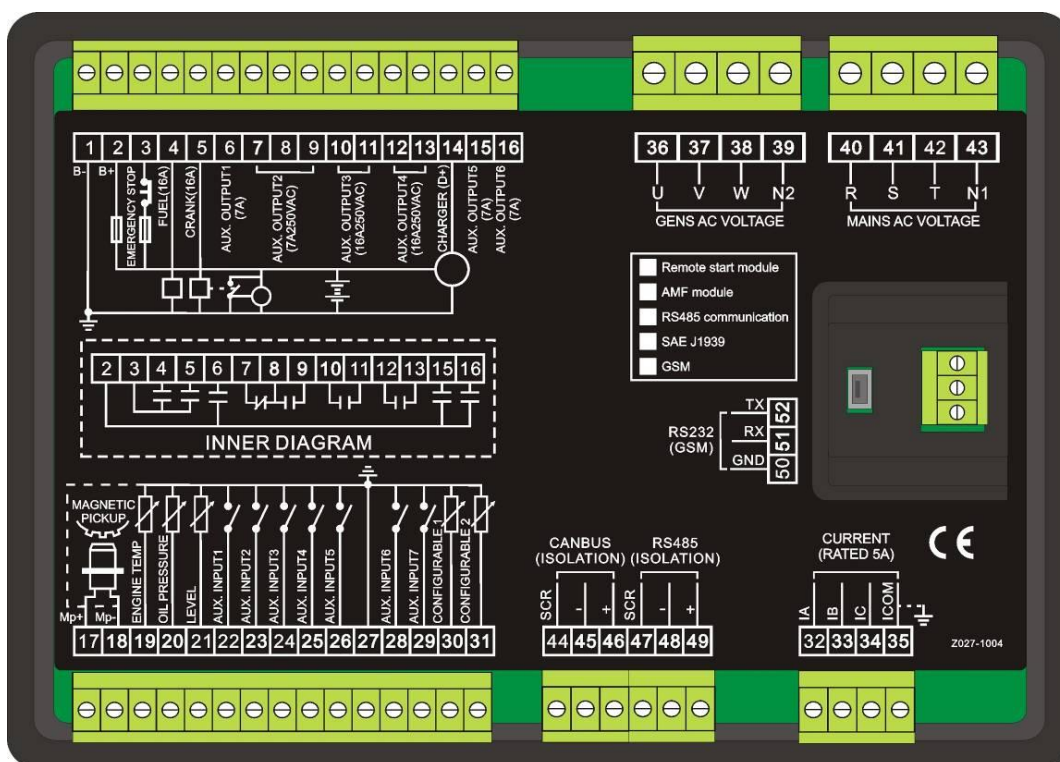

Description of terminal connection:

No.	Functions	Diameter	Remark
1	DC input -ve	2.5mm ²	Connected with negative of starter battery
2	DC input +ve	2.5mm ²	Connected with positive of starter battery. If wire length is over 30m, better to double wires in parallel. Max. 20A fuse is recommended.
3	Emergency stop	2.5mm ²	Connected to +Ve via emergency stop button
4	Fuel relay output	1.5mm ²	+Ve is supplied by 3 point, rated 16A
5	Start relay output	1.5mm ²	+Ve is supplied by 3 point, rated 16A Connected to coil of starter
6	Aux. Output 1	1.5mm ²	+Ve is supplied by 2 point, rated 7A
7	Aux. Output 2	1.5mm ²	Normally close outputs, rated 7A
8			Public points of relay
9			Normally open outputs, rated 7A
10	Aux. Output 3	2.5mm ²	Normally open passive contacts of relay, rated 16A, passive contact
11			
12			
13			

No.	Functions	Diameter	Remark	
14	Charge generator D+ port input	1.0mm ²	Connected to charging starter's D+ (WL) terminals. If there is no this terminal, and be hung up.	
15	Aux. Output 5	1.5mm ²	+Ve supplied by 2 point, rated 7A	Details see form 2
16	Aux. Output 6	1.5mm ²		
17	Magnetic pickup	Connected to Magnetic Pickup, shielding line is recommended		
18	Magnetic pickup input, and controller inner be connected to battery negative.			
19	Temperature sensor input	Connected to temp. Sensor		Setting items see form 4
20	Oil pressure sensor input	Connected to oil pressure sensor		
21	Oil level sensor input	Connected to oil level sensor		
22	Aux input 1	1.0mm ²	Ground connected is active (- Ve)	Setting items see form 3
23	Aux input 2	1.0mm ²		
24	Aux input 3	1.0mm ²		
25	Aux input 4	1.0mm ²		
26	Aux input 5	1.0mm ²		
27	Public terminals of sensor	Public terminals of sensor, controller inner are connected to battery negative.		
28	Aux input 6	1.0mm ²	Ground connected is active (-Ve)	Setting items see form 3
29	Aux input 7	1.0mm ²		
30	Configurable sensor 1	Connected to temperature, oil Pressure or fuel level sensors		Setting items see form 4
31	Configurable sensor 2			
32	CT A-phase sensing input	1.5mm ²	Outside connected to secondary coil of current transformer(rated 5A)	
33	CT B-phase sensing input	1.5mm ²	Outside connected to secondary coil of current transformer(rated 5A)	
34	CT C-phase sensing input	1.5mm ²	Outside connected to secondary coil of current transformer(rated 5A)	
35	Public terminals of current transformer	1.5mm ²	See following installation instruction	
36	Genset A-phase Voltage sensing input	1.0mm ²	Connected to A-phase output of genset (2A fuse is recommended)	
37	Genset B-phase	1.0mm ²	Connected to B-phase output of genset (2A	

No.	Functions	Diameter	Remark
	voltage sensing input		fuse is recommended)
38	Genset C-phase voltage sensing input	1.0mm ²	Connected to C-phase output of genset (2A fuse is recommended)
39	Genset N-wire input	1.0mm ²	Connected to output N-wire of genset
40	Mains A-phase voltage sensing input	1.0mm ²	Connected to A-phase of mains (2A fuse is recommended) (HGM7X10 without)
41	Mains B-phase voltage sensing input	1.0mm ²	Connected to B-phase of mains (2A fuse is recommended) (HGM7X10 without)
42	Mains C-phase voltage sensing input	1.0mm ²	Connected to C-phase of mains (2A fuse is recommended) (HGM7X10 without)
43	Mains N-wire input	1.0mm ²	Connected to output N-wire of mains (HGM7X10 without)
44	CAN screen		Impedance-120Ω shielding wire is recommended, its single-end earthed (controllers without CANBUS function don't have this terminal)
45	CAN(L)	0.5mm ²	
46	CAN(H)	0.5mm ²	
47	RS485 screen		Impedance-120Ω shielding wire is recommended, its single-end earthed (controllers without RS485 don't have this terminal)
48	RS485-	0.5mm ²	
49	RS485+	0.5mm ²	
50	RS232 GND	0.5mm ²	Connected to GSM module (HGM7100A series without these terminals or reserve these terminals)
51	RS232 RX	0.5mm ²	
52	RS232 TX	0.5mm ²	

▲ **NOTE:** USB ports in controller rear panel are programmable parameter ports, user can directly configure controller via PC.

▲ **NOTE:** Please refer to the [Model Comparison](#) in this manual for more products' functions.

8 SCOPES AND DEFINITIONS OF PROGRAMMABLE PARAMETERS

8.1 CONTENTS AND SCOPES OF PARAMETERS

Form 1

No.	Items	Parameters	Defaults	Description
Mains Setting				
1	AC System	(0-3)	0	0: 3P4W; 1: 3P3W; 2: 2P3W; 3: 1P2W.
2	Rated Voltage	(30-30000)V	230	Standard for checking mains over/under voltage. (This value is primary voltage of transformer).
3	Rated Frequency	(10.0-75.0)Hz	50.0	Standard for checking mains over/under frequency.
4	Normal Time	(0-3600)s	10	The delay from abnormal to normal.
5	Abnormal Time	(0-3600)s	5	The delay from normal to abnormal.
6	Volt. Trans.(PT)	(0-1)	0	0: Disable ; 1: Enable
7	Over Voltage	(0-1000)%	120	Setting value is mains rated voltage's percentage, and return and delay values also can be set.
8	Under Voltage	(0-1000)%	80	
9	Over Frequency	(0-1000)%	Disable	Setting value is mains rated frequency's percentage, , return and delay values also can be set.
10	Under Frequency	(0-1000)%	Disable	
11	Loss of Phase	(0-1)	1	0: Disable; 1: Enable
12	Reverse Phase	(0-1)	1	
Timer Setting				
1	Start Delay	(0-3600)s	1	Time from mains abnormal or remote start signal is active to start genset.
2	Stop Delay	(0-3600)s	1	Time from mains normal or remote start signal is inactive to genset stop.
3	Preheat Delay	(0-3600)s	0	Time of pre-powering heat plug before starter is powered up.

No.	Items	Parameters	Defaults	Description
4	Cranking Time	(3-60)s	8	Time of starter power up each time.
5	Crank Rest Time	(3-60)s	10	The second waiting time before power up when engine start fail.
6	Safety On Delay	(0-3600)s	10	Alarms for low oil pressure high temp, under speed, under frequency/voltage, charge fail are inactive.
7	Start Idle Time	(0-3600)s	0	Idle running time of genset when starting.
8	Warming Up Time	(0-3600)s	10	Warming time before genset switch on, after it into high speed running.
9	Cooling Time	(0-3600)s	10	Radiating time before genset stop, after it unloads.
10	Stop Idle Time	(0-3600)s	0	Idle running time when genset stop.
11	ETS Solenoid Hold	(0-3600)s	20	Stop electromagnet's power on time when genset is stopping.
12	Fail To Stop Delay	(0-3600)s	0	Time from over of idle delay to stopped when "ETS time" is set as 0; Time from over of ETS hold delay to stopped when "ETS Hold output time" is not 0.
13	After Stop Time	(0-3600)s	0	Time from genset stopped to standby
Engine Setting				
1	Engine Type	(0-39)	0	Default, common genset (not J1939). When connected to J1939 engine, choose the correspond type.
2	Flywheel Teeth	(10-300)	118	Teeth number of the engine for judging of starter disconnection and inspecting speed of engine.
3	Rated Speed	(0-6000)RPM	1500	Offer standard to judge over/under/loading speed.
4	Speed on Load	(0-100)%	90	Setting value is percentage of rated speed. Controller

No.	Items	Parameters	Defaults	Description
				detects when will load. Won't switch on when speed is under loading speed.
5	Loss Of Speed Signal	(0-3600)s	5	Time from detecting speed is 0 to confirm the actions.
6	Loss Of Speed Action	(0-1)	0	0:Warn; 1:Shutdown
7	Over Speed Shutdown	(0-200)%	114	Setting value is percentage of rated speed and delay value also can be set.
8	Under Speed Shutdown	(0-200)%	80	
9	Over Speed Warn	(0-200)%	110	Setting value is percentage of rated speed and delay & return values also can be set.
10	Under Speed Warn	(0-200)%	86	
11	Battery Rated Voltage	(0-60.0)V	24.0	Standard for detecting of over/under voltage of battery.
12	Battery Over Volts	(0-200)%	120	Setting value is percentage of rated voltage of battery and delay & return values also can be set.
13	Battery Under Volts	(0-200)%	85	Setting value is percentage of rated voltage of battery and delay & return values also can be set.
14	Charge Alt Fail	(0-60.0)V	8.0	In normal running, when charger voltage under this value, charge fail alarms.
15	Start Attempts	(1-10) times	3	Max. Crank times of start failure. When reach this number, controller will send start failure signal
16	Crank Disconnect	(0-6)	2	Conditions of disconnecting starter with engine. Each condition can be used alone and simultaneously.
17	Disconnect Generator Freq	(0-200)%	24	When gens freq. over pre-setting, starter will be disconnected.
18	Disconnect Engine Speed	(0-200)%	24	When gens rotate speed over pre-setting, starter will be disconnected.
19	Disconnect Oil Pressure	(0-1000)kPa	Not used.	When oil pressure over pre-setting, starter will be disconnected.
Generator Setting				
1	AC System	(0-3)	0	0: 3P4W; 1: 3P3W; 2:

No.	Items	Parameters	Defaults	Description
				2P3W; 3: 1P2W.
2	Poles	(2-32)	4	Number of generator poles, for calculating starter rotate speed when without speed sensor.
3	Rated Voltage	(30-30000)V	230	Offer standards for detecting of gens' over/under voltage and loading volt. If using voltage transformer, this value is primary volt of transformer.
4	Loading Voltage	(0-200)%	85	Setting value is percentage of gens rated volt. When under load voltage, won't enter into normal running, during the period, controller ready to detect loading.
5	Rated Frequency	(10.0-600.0)Hz	50.0	Offer standards for detecting of over/under/load frequency.
6	Loading Frequency	(0-200)%	85	Setting value is percentage of gens rated freq. When under load frequency, won't enter into normal running, during the period, controller ready to detect loading.
7	Volt. Trans.(PT)	(0-1)	0	0: Disable; 1: Enable
8	Over Volt. Shutdown	(0-200)%	120	Setting value is percentage of gens rated volt. Delay value also can be set.
9	Under Volt. Shutdown	(0-200)%	80	
10	Over Freq. Shutdown	(0-200)%	114	Setting value is percentage of gens rated freq. Delay value also can be set.
11	Under Freq. Shutdown	(0-200)%	80	
12	Over Volt. Warn	(0-1000)%	110	Setting value is percentage of gens rated volt. Delay and return value also can be set.
13	Under Volt. Warn	(0-1000)%	84	
14	Over Freq. Warn	(0-1000)%	110	
15	Under Frequency Warn	(0-1000)%	84	
16	Loss of Phase	(0-1)	1	0: Disable 1: Enable
17	Phase Sequence Wrong	(0-1)	1	

No.	Items	Parameters	Defaults	Description
Load Setting				
1	Current Trans.	(5-6000)/5	500	The change of external connected CT
2	Full Current Rating	(5-6000)A	500	Generator's rated current, standard of load current.
3	Full kW rating	(0-6000)kW	276	Generator's rated power, standard of load current.
4	Over Current	(0-200)%	120	Setting value is percentage of gens rated volt. Delay value also can be set.
5	Over Power	(0-1)	0	0: Disable 1: Enable.
6	Reverse Power	(0-1)	0	0: Disable 1: Enable.
Switch Setting				
1	Transfer Time	(0-7200)s	5	Interval time from mains switch off to gens switch on; or from gens switch off to mains switch on.
2	Close Time	(0-20.0)s	5.0	Pulse width of mains/gens switch on. When it is 0, means output constantly.
3	Open Time	(0-20.0)s	3.0	Pulse width of mains/generator switch off.
4	Check Time	(0-20.0)s	5.0	Time of detecting switch auxiliary contacts after transferred.
5	Warn Enable	(0-1)	0	0: Disable 1: Enable.
6	Check Enable	(0-1)	0	
Module Setting				
1	Power on Mode	(0-2)	0	0:Stop mode 1:Manual mode 2:Auto mode
2	Module Address	(1-254)	1	Controller's address during remote monitoring.
3	Stop Bits	(0-1)	0	0: 2 stop bits; 1: 1 stop bit
4	Language	(0-2)	0	0: Simplified Chinese 1: English 2: Others
5	Password	(0-65535)	318	For entering advanced parameters setting.
GSM Setting				
1	GSM Enable	(0-1)	0	0: Disable; 1: Enable
2	Phone Number	Max.20 digits		Must be added its national and area's cods.
Scheduling And Maintenance Setting				
1	Scheduled Run	(0-1)	0	0: Disable; 1: Enable

No.	Items	Parameters	Defaults	Description
2	Scheduled Not Run	(0-1)	0	0: Disable; 1: Enable
3	Maintenance	(0-1)	0	0: Disable; 1: Enable
Analog Sensors Setting				
Temperature Sensor				
1	Curve Type	(0-15)	7	SGX See form 4.
2	Open Circuit Action	(0-2)	0	0: Warn; 1: Shutdown; 2: No action
3	High Temp. Shutdown	(0-300)°C	98	Warn when temperature over this value. Detecting only after safety delay is over. The delay value also can be set.
4	High Temp. Warn	(0-300)°C	95	Warn when temperature is over this value. Detecting only after safety delay is over. The delay and return value also can be set.
5	Low Temp. Warn	(0-1)	0	0: Disable; 1: Enable
Oil Pressure Sensor				
1	Curve Type	(0-15)	7	SGX See form 4.
2	Open Circuit Action	(0-2)	0	0: Warn; 1: Shutdown; 2: No action
3	Low OP Shutdown	(0-1000)kPa	103	Warn when pressure over this value. Detecting only after safety delay is over. The delay value also can be set.
4	Low OP Warn	(0-1000)kPa	124	Warn when pressure over this value. Detecting only after safety delay is over. The delay and return value also can be set.
Liquid Level Sensor				
1	Curve Type	(0-15)	4	SGH See form 4.
2	Open Circuit Action	(0-2)	0	0: Warn; 1: Shutdown; 2: No action
3	Low Level Warn	(0-300)%	10	Warn when level under this value. Detecting all the time. The delay and return value also can be set.
Flexible Sensor 1				
1	Flexible Sensor 1 Setting	(0-1)	0	0: Disable; 1: Enable (can be set as

No.	Items	Parameters	Defaults	Description
				temperature/pressure/liquid lever sensor).
Flexible Sensor 2				
1	Flexible Sensor 2 Setting	(0-1)	0	0: Disable; 1: Enable; (can be set as temperature/pressure/liquid lever sensor).
Flexible Input Ports				
Flexible Input Port 1				
1	Contents Setting	(0-50)	28	Remote start (with load). See form 3.
2	Active Type	(0-1)	0	0: Closed to active 1: Open to active
Flexible Input Port 2				
1	Contents Setting	(0-50)	26	Hi-temperature shutdown input See form 3.
2	Active Type	(0-1)	0	0: Closed to active 1: Open to active
Flexible Input Port 3				
1	Contents Setting	(0-50)	27	Low oil pressure shutdown input. See form 3.
2	Active Type	(0-1)	0	0: Closed to active 1: Open to active
Flexible Input Port 4				
1	Contents Setting	(0-50)	0	User defined. See form 4.
2	Active Type	(0-1)	0	0: Closed to active 1: Open to active
3	Arming	(0-3)	2	0: From safety on 1: From starting 2: Always 3:Never
4	Active Actions	(0-4)	0	0: Warn; 1: Shutdown; 2:Trip and stop 3:Trip 4: Indication
5	Active Delay	(0-20.0)s	2.0	Time from detecting input active to confirm
6	Description			LCD display detailed contents when the input is active.
Flexible Input Port 5				
1	Contents Setting	(0-50)	0	User defined
2	Active Type	(0-1)	0	0: Closed to active 1: Open to active
3	Arming	(0-3)	2	0: From safety on 1: From starting

No.	Items	Parameters	Defaults	Description
				2: Always 3:Never
4	Active Actions	(0-4)	1	0: Warn; 1: Shutdown; 2:Trip and stop 3:Trip 4: Indication
5	Active Delay	(0-20.0)s	2.0	Time from detecting input active to confirm
6	Description			LCD display detailed contents when the input is active.
Flexible Input Port 6				
1	Contents Setting	(0-50)	0	User defined
2	Active Type	(0-1)	0	0: Closed to active 1: Open to active
3	Arming	(0-3)	2	0: From safety on 1: From starting 2: Always 3:Never
4	Active Actions	(0-4)	2	0: Warn; 1: Shutdown; 2:Trip and stop 3:Trip 4: Indication
5	Active Delay	(0-20.0)s	2.0	Time from detecting input active to confirm
6	Description			LCD display detailed contents when the input is active.
Flexible Input Port 7				
1	Contents Setting	(0-50)	5	Lamb test
2	Active Type	(0-1)	0	0: Closed to active 1: Open to active
Flexible Output Ports				
Flexible Output Port 1				
1	Contents Setting	(0-239)	1	User defined period output (default is output in preheating) See form 2.
2	Active Type	(0-1)	0	0:Normally open; 1:Normally close
Flexible Output Port 2				
1	Contents Setting	(0-239)	35	Idle control output. See form 2.
2	Active Type	(0-1)	0	0:Normally open; 1:Normally close
Flexible Output Port 3				
1	Contents Setting	(0-239)	29	Gens close output. See form 2.
2	Active Type	(0-1)	0	0:Normally open; 1:Normally close

No.	Items	Parameters	Defaults	Description
Flexible Output Port 4				
1	Contents Setting	(0-239)	31	Mains close output. See form 2.
2	Active Type	(0-1)	0	0:Normally open; 1:Normally close
Flexible Output Port 5				
1	Contents Setting	(0-239)	38	ETS hold. See form 2.
2	Active Type	(0-1)	0	0:Normally open; 1:Normally close
Flexible Output Port 6				
1	Contents Setting	(0-239)	48	Common alarm. See form 2.
2	Active Type	(0-1)	0	0:Normally open; 1:Normally close

8.2 ENABLE DEFINITION OF PROGRAMMABLE OUTPUT PORTS

Form 2

No.	Type	Description
0	Not Used	
1	Custom Period 1	Details of function description please see the following.
2	Custom Period 2	
3	Custom Period 3	
4	Custom Period 4	
5	Custom Period 5	
6	Custom Period 6	
7	Custom Combined 1	
8	Custom Combined 2	
9	Custom Combined 3	
10	Custom Combined 4	
11	Custom Combined 5	
12	Custom Combined 6	
13	Reserved	
14	Reserved	
15	Reserved	
16	Reserved	
17	Air Flap	Action in over speed alarm stop and emergence stop. It also can close the air inflow the engine.
18	Audible Alarm	Action in warning, shutdown, trips. Can be connected outside alarm. When programmable input port is active of "alarm mute", can prohibit its output.
19	Louver Control	Action in genset starting and disconnect when genset stopped completely.
20	Fuel Pump Control	It is controlled by fuel pump of level sensor's limited threshold.
21	Heater Control	It is controlled by heating of temperature sensor's setting bound.
22	Cooler Control	It is controlled by cooler of temperature sensor's setting bound.
23	Pre-oil Supply Output	Action from "crank on" to "safety on".
24	Excite Generator	Output in start period. If there is no gens frequency during hi-speed running, output 2 seconds again.
25	Pre-Lubricate	Actions in period of pre-heating to safety run.
26	Remote PC Output	This port is controlled by communication (PC).
27	GSM Power	Power for GSM module (GSM module is power-off reset when GSM communication failed).

28	Reserved	
29	Close Generator	Control switch of gens is load.
30	Open Breaker	Control switch is uninstalling.
31	Close Mains	Control switch of mains is load.
32	Reserved	
33	Crank Relay	
34	Fuel Relay	Action when genset is starting and disconnect when shutdown completed.
35	Idle Control	Used for engine which has idles. Pull in before starting and pull out after into hi-speed warming; Pull in during stopping idle mode and pull out after shutdown completed.
36	Raise Speed	Action in hi-speed warming run.
37	Drop Speed	Action in period of stop idle mode to time of wait for stopping completely.
38	ETS Control	Used for engines with ETS electromagnet. Pull in when stop idle is over and pull out when set "ETS delay" is over.
39	Pulse droop output	The genset act for 0.1s when it enters into speed idle mode. It is used to control part of ECU droop to idle.
40	ECU Stop	Used for ECU engine and control its stop.
41	ECU Power	Used for ECU engine and control its power.
42	Pulse raise speed	The genset act for 0.1s when it enters into high speed warming mode. It is used to control part of ECU accelerate to normal speed.
43	Crank Disconnect	Pull in when detects a successful start signal.
44	Generator OK	Action when gens are normal.
45	Generator Available	Action in period of gens ok to hi-speed cooling.
46	Mains OK	Action when mains normal.
47	Reserved	
48	Common Alarm	Action in gens common warning, common shutdown, common trips alarm.
49	Common Trip and Stop	Action in common trips shutdown alarm.
50	Common Shutdown	Action in common shutdown alarm.
51	Common Trip Alarm	Action in common trips and not shutdown alarm.
52	Common Warn Alarm	Action in common warning alarm.
53	Reserved	
54	Battery High Volts	An action in battery's over voltage warning alarm.
55	Battery Low Volts	Action in battery's low voltage warning alarm.
56	Charge Alt Fail	Action in charge alt fail warning alarm.
57	Reserved	
58	Reserved	
59	Reserved	

60	ECU Warn	Indicate ECU sends a warning alarm signal.
61	ECU Shutdown	Indicate ECU sends a shutdown alarm signal.
62	ECU Com Fail	Indicate controller not communicates with ECU.
63	Reserved	
64	Reserved	
65	Reserved	
66	Reserved	
67	Reserved	
68	Reserved	
69	Aux Input 1 Active	Action when input port 1 is active
70	Aux Input 2 Active	Action when input port 2 is active
71	Aux Input 3 Active	Action when input port 3 is active
72	Aux Input 4 Active	Action when input port 4 is active
73	Aux Input 5 Active	Action when input port 5 is active
74	Aux Input 6 Active	Action when input port 6 is active
75	Aux Input 7 Active	Action when input port 7 is active
76-98	Reserved	
99	Emergency Stop	Action in emergency stop alarm.
100	Fail To Start	Action in failed start alarm.
101	Fail To Stop	Action in failed stop.
102	Under Speed Warn	Action in under speed warning.
103	Under Speed Shutdown	Action in under speed shutdown.
104	Over Speed Warn	Action in over speed warning.
105	Over Speed Shutdown	Action in over speed shutdown alarm.
106	Reserved	
107	Reserved	
108	Reserved	
109	Gen over frequency Warn	Action in gens over frequency warning.
110	Gen over frequency Shut	Action in gens over frequency shutdown alarm.
111	Gen Over Volt Warn	Action in gens over voltage warning.
112	Gen Over Volt Shut	Action in gens over voltage shutdown.
113	Gen Under Freq. Warn	Action in gens low frequency warning.
114	Gen Under Freq. Shut	Action in gens low frequency shutdown.
115	Gen Under Volt. Warn	Action in gens low voltage warning.
116	Gen Under Volt. Shut	Action in gens low voltage shutdown.
117	Gen Loss of Phase	Action in gens loss phase.
118	Gen Reverse Phase	Action in gens reverse phase.
119	Reserved	
120	Over Power	
121	Reserved	
122	Reverse Power	Action in controller detects gens have reverse

		power.
123	Over Current	Action in over current.
124	Reserved	
125	Mains Inactive	
126	Mains Over Freq	
127	Mains Over Volt	
128	Mains Under Freq	
129	Mains Under Volt	
130	Mains Reverse Phase	
131	Mains Loss of Phase	
132-138	Reserved	
139	High Temp Warn	Action in hi-temperature warning alarm.
140	Low Temp Warn	Action in low temperature warning alarm.
141	High Temp Shutdown	Action in hi-temp. Shutdown alarm.
142	Reserved	
143	Low OP Warn	Action in low oil pressure warning alarm.
144	Low OP Shutdown	Action in low oil pressure shutdown.
145	OP Sensor Open	Action when oil pressure sensor are open circuit.
146	Reserved	
147	Low Level Warn	Action when controller has low oil level alarm.
148	Reserved	
149	Reserved	
150	Config1 High Warn	
151	Config1 Low Warn	
152	Config1 High Shut	
153	Config1 Low Shut	
154	Config2 High Warn	
155	Config2 Low Warn	
156	Config2 High Shut	
157	Config2 Low Shut	
158-229	Reserved	
230	Stop Mode	Action in stop mode.
231	Manual Mode	Action in Manual mode.
232	Test Mode	Action in Manual test mode.
233	Auto Mode	Action in Auto mode.
234	Generator On Load	
235	Mains On Load	
236	Reserved	
237	Reserved	
238	Reserved	
239	Reserved	

8.2.1 DEFINED PERIOD OUTPUT

Defined Period output is made of 2 parts, period output S1 and condition output S2.



While S1 and S2 are **TRUE** synchronously, **OUTPUT**;

While S1 or S2 is **FALSE**, **NOT OUTPUT**.

Period output S1, can set generator's one or more period output freely, can set the delayed time and output time after into period.

Condition output S2; can set as any conditions in output ports.

▲ NOTE: when delay time and output time both are 0 in period output S1, it is **TRUE** in this period.

▲ NOTE: The controller will output circularly only when output period is in standby period.

Example,

Output period: start

Delay output time: 2s

Output time: 3s

Condition output contents: output port 1 is active

Close when condition output active/inactive: close when active (disconnect when inactive);

Output port 1 active, after enter "starts time" and delay 2s, this defined period output is outputting, after 3s, stop outputting;

Output port 1 inactive, defined output period is not outputting.

8.2.2 CUSTOM COMBINED OUTPUT

Defined combination output is composed by 3 parts, condition output S1 or S2 and condition output S3.

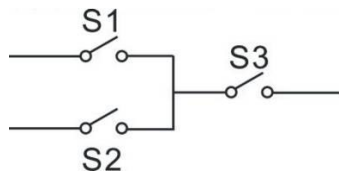

S1 or S2 is **TRUE**, while S3 is **TRUE**, Defined combination output is outputting;

S1 and S2 are **FALSE**, or S3 is **FALSE**, Defined combination output is not outputting.

▲ NOTE: S1, S2, S3 can be set as any contents except for "defined combination output" in the output setting.

▲ NOTE: 3 parts of defined combination output (S1, S2, S3) couldn't include or recursively include themselves.

Example,

Contents of probably condition output S1: output port 1 is active;

Close when probably condition output S1 is active /inactive: close when active (disconnect when inactive);

Contents of probably condition output S2, output port 2 is active;

Close when probably condition output S2 is active /inactive: close when active (disconnect when inactive);

Contents of probably condition output S3: output port 3 is active;

Close when probably condition output S3 is active /inactive: close when active (disconnect when inactive);



When input port 1 active or input port 2 active, if input port 3 is active, Defined combination output is outputting; If input port 3 inactive, Defined combination output is not outputting;

When input port 1 inactive and input port 2 inactive, whatever input port 3 is active or not, Defined combination output is not outputting.

8.3 DEFINED CONTENTS OF CONFIGURABLE INPUT PORTS (ALL ACTIVE WHEN CONNECT TO GRAND (B-))

Form 3

No.	Type	Description
0	Users Configured	Including following functions, Indication: indicate only, not warning or shutdown. Warning: warn only, not shutdown. Shutdown: alarm and shutdown immediately Trip and stop: alarm, generator unloads and shutdown after hi-speed cooling Trip: alarm, generator unloads but not shutdown. Never: input inactive. Always: input is active all the time. From crank: detecting as soon as start. From safety on: detecting after safety on run delay.
1	Reserved	
2	Alarm Mute	Can prohibit "Audible Alarm" output when input is active.
3	Reset Alarm	Can reset shutdown alarm and trip alarm when input is active.
4	60Hz Active	Use for CANBUS engine and it is 60Hz when input is active.
5	Lamp Test	All LED indicators are illuminating when input is active.
6	Panel Lock	All buttons in panel is inactive except  and there is  in the left of first row in LCD when input is active.
7	Reserved	
8	Idle Control Mode	Under voltage/frequency/speed protection is inactive.
9	Inhibit Auto Stop	In Auto mode, during generator normal running, when input is active, inhibit generator shutdown automatically.
10	Inhibit Auto Start	In Auto mode, inhibit generator start automatically when input is active.
11	Inhibit Scheduled	In Auto mode, inhibit scheduled run genset when input is active.
12	Reserved	
13	Aux Gen Closed	Connect generator loading switch's Aux. Point.

14	Inhibit Gen Load	Prohibit genset switch on when input is active.
15	Aux Mains Closed	Connect mains loading switch's Aux. Point.
16	Inhibit Mains Load	Prohibit mains switch on when input is active.
17	Auto Mode Lock	When input is active, controller enters into Auto mode; all the keys except  are inactive, and  will show in the first line of LCD display.
18	Auto Mode Invalid	When input is active, controller won't work under Auto mode.  key and simulate auto key input does not work.
19	Reserved	
20	Reserved	
21	Inhibit Alarm Stop	All shutdown alarms are prohibited except emergence stop.(Means battle mode or override mode)
22	Aux Instrument Mode	All outputs are prohibited in this mode.
23	Reserved	
24	Reset Maintenance	Controller will set maintenance time and date as default when input is active.
25	Reserved	
26	Aux. High Temp	Connected sensor digital input.
27	Aux. Low OP	Connected sensor digital input.
28	Remote Start (On Load)	In Auto mode, when input active, genset can be started and with load after genset is OK; when input inactive, genset will stop automatically.
29	Remote Start (Off Load)	In Auto mode, when input is active, genset can be started and without load after genset is OK; when input is inactive, genset will stop automatically.
30	Aux. Manual Start	In Auto mode, when input active, genset will start automatically; when input inactive, genset will stop automatically
31	Reserved	
32	Reserved	
33	Simulate Stop key	An external button can be connected and pressed as simulate panel.
34	Simulate Manual key	
35	Simulate Manual Test key	
36	Simulate Auto key	An external button can be connected and pressed as simulate panel.
37	Simulate Start key	
38	Simulate G-Load key	This is simulate G-close key when HGM9610 controller is applied.

39	Simulate M-Load key	This is simulate M-open key when HGM9610 controller is applied.
40	Reserved	
41	Reserved	
42	Reserved	
43	Reserved	
44	Reserved	
45	Aux Mains OK	In Auto mode, mains are normal when input is active.
46	Aux Mains Fail	In Auto mode, mains are abnormal when input is active.
47	Alternative Config1	Users can set different parameters to make it easy to select current configuration via input port.
48	Alternative Config2	
49	Alternative Config3	
50	Reserved	

8.4 SELECTION OF SENSORS

Form4

No.		Description	Remark
1	Temperature Sensor	0 Not used 1 Custom Res Curve 2 Custom 4-20mA curve 3 VDO 4 CURTIS 5 VOLVO-EC 6 DATCON 7 SGX 8 SGD 9 SGH 10 PT100 11~15 Reserved	Defined resistance's range is 0~6K Ω , default is SGX sensor.
2	Pressure Sensor	0 Not used 1 Custom Res Curve 2 Custom 4-20mA curve 3 VDO 10Bar 4 CURTIS 5 VOLVO-EC 6 DATCON 10Bar 7 SGX 8 SGD 9 SGH 10~15 Reserved	Defined resistance's range is 0~6K Ω , default is SGX sensor.
3	Oil Level Sensor	0 Not used 1 Custom Res Curve 2 Custom 4-20mA curve 3 SGD 4 SGH 5~15 Reserved	Defined resistance's range is 0~6K Ω , default is SGH sensor.

▲ NOTE: User should make special declare when order controller if your genset equip for sensor of 4-20mA.

8.5 CONDITIONS OF CRANK DISCONNECT SELECTION

No.	Setting description
0	Gens frequency
1	Speed sensor
2	Speed sensor + Gens frequency
3	Oil pressure
4	Oil pressure + Gen frequency
5	Oil pressure + Speed sensor
6	Oil pressure + Speed sensor + Gen frequency

▲ NOTE:

1. There are 3 conditions to make starter disconnected with engine, that is, speed sensor, generator frequency and engine oil pressure. They all can be used separately. We recommend that engine oil pressure should be using with speed sensor and generator frequency together, in order to make the starter motor is separated with engine immediately and can check crank disconnect exactly.
2. Speed sensor is the magnetic equipment which be installed in starter for detecting flywheel teeth.
3. When set as speed sensor, must ensure that the number of flywheel teeth is as same as setting, otherwise, "over speed stop" or "under speed stop" may be caused.
4. If genset without speed sensor, please don't select corresponding items, otherwise, "start fail" or "loss speed signal" maybe caused.
5. If genset without oil pressure sensor, please don't select corresponding items.
6. If not select generator in crank disconnect setting, controller will not collect and display the relative power quantity (can be used in water pump set); if not select speed sensor in crank disconnect setting, the rotating speed displayed in controller is calculated by generator frequency and number of poles.

9 PARAMETERS SETTING

In HGM7x10 series controller, there are no items of mains in setting and also no mains items in configurable ports of input/output.

⚠CAUTION: Please change the controller parameters when generator is in stand-by mode only (e. g. Start conditions selection, configurable input, configurable output, various delay), otherwise, alarming to stop and other abnormal conditions may happen.

⚠NOTE: Maximum set value must over minimum set value in case that the condition of too high as well as too low will happen.

⚠NOTE: When setting the warning alarm, please set the correct return value; otherwise, maybe there is abnormal alarm. When setting the maximum value, the return value must less than setting; When setting the minimum value, the return value must over setting.

⚠NOTE: Please set the generator frequency value as low as possible when cranking, in order to make the starter be separated quickly as soon as crank disconnect.

⚠NOTE: Configurable input could not be set as same items; otherwise, there are abnormal functions. However, the configurable output can be set as same items.

10 SENSORS SETTING

1. When reselect sensors, the sensor curve will be transferred into the standard value. For example, if temperature sensor is SGX (120°C resistor type), its sensor curve is SGX (120°C resistor type); if select the SGD (120°C resistor type), the temperature sensor curve is SGD curve.
2. When there is difference between standard sensor curves and using sensor, user can adjust it in “curve type”.
3. When input the sensor curve, X value (resistor) must be input from small to large, otherwise, mistake occurs.
4. If select sensor type as “None”, sensor curve is not working.
5. If corresponding sensor has alarm switch only, user must set this sensor as “None”, otherwise, maybe there is shutdown or warning.
6. The headmost or backmost values in the vertical coordinates can be set as same as below,

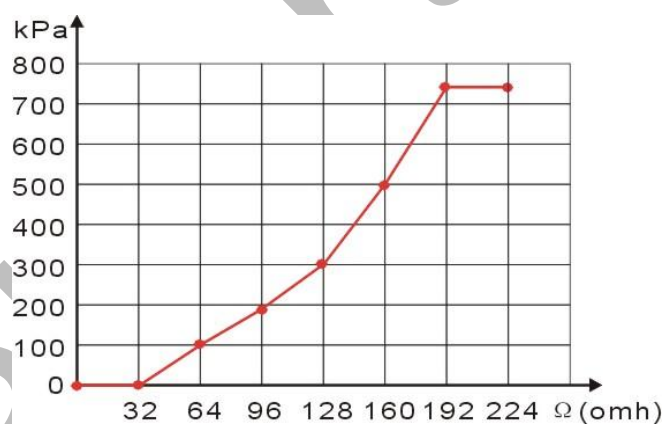

Normal Pressure Unit Conversion Form

	pa	kgf/cm ²	bar	psi
1Pa	1	1.02×10^{-5}	1×10^{-5}	1.45×10^{-4}
1kgf/cm ²	9.8×10^4	1	0.98	14.2
1bar	1×10^5	1.02	1	14.5
1psi	6.89×10^3	7.03×10^{-2}	6.89×10^{-2}	1

11 COMMISSIONING

Please make the under procedures checking before commissioning,

1. Ensure all the connections are correct and wires diameter is suitable.
2. Ensure that the controller DC power has fuse, controller's positive and negative connected to start battery are correct.
3. Emergence stop must be connected with positive of start battery via scram button's normal close point and fuse.
4. Take proper action to prevent engine to crank disconnect (e. g. Remove the connection wire of fuel valve). If checking is OK, make the start battery power on; choose manual mode and controller will executive routine.
5. Set controller under manual mode, press "start" button, genset will start. After the setting times as setting, controller will send signal of Start Fail; then press "stop" to make controller as reset.
6. Recover the action of stop engine start (e. g. Connect wire of fuel valve), press start button again, genset will start. If everything goes well, genset will normal run after idle running (if idle run be set). During this time, please watch for engine's running situations and AC generator's voltage and frequency. If abnormal, stop genset running and check all wires connection according to this manual.
7. Select the **AUTO** mode from controller's panel, connect mains signal. After the mains normal delay, controller will transfer ATS (if fitted) and into mains load. After cooling time, controller will stop genset and make it in to "at rest" mode until there is abnormal of mains.
8. When mains is abnormal again, genset will be started automatically and into normal running, then controller send signal to make generator switch on, and control the ATS as generator load. If not like this, please check ATS' wires connection of control part according to this manual.
9. If there is any other question, please contact Smartgen's service.

12 TYPICAL APPLICATION

HGM7210 typical application diagram

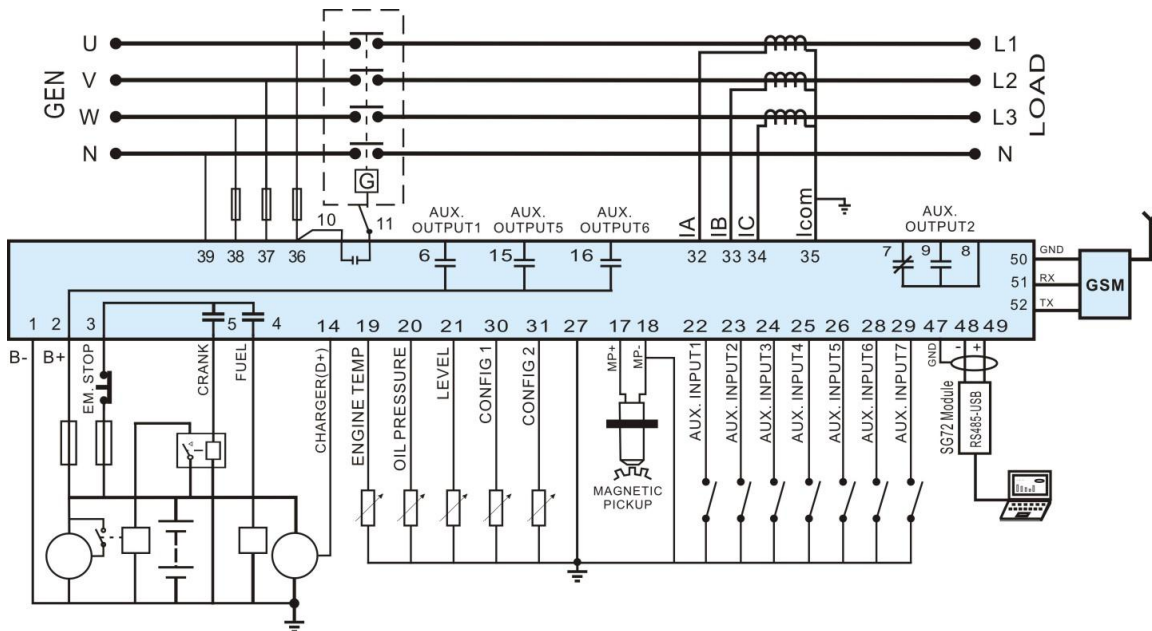

HGM7220 typical application diagram

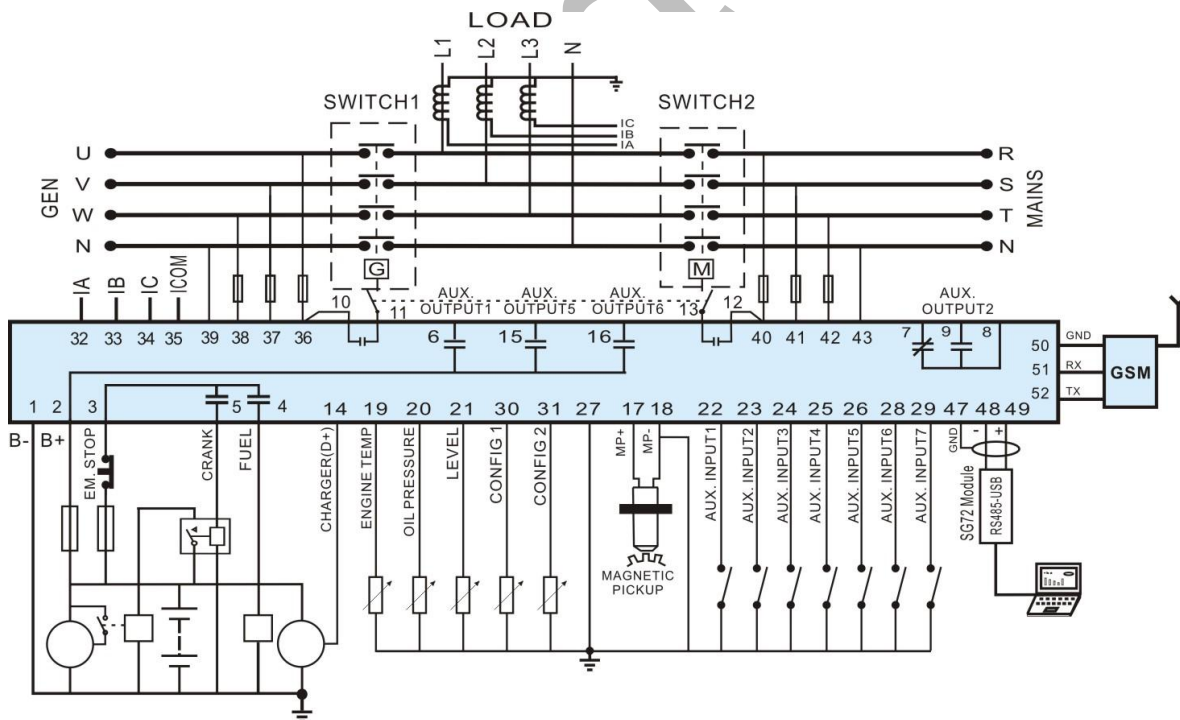

HGM7210CAN typical application diagram

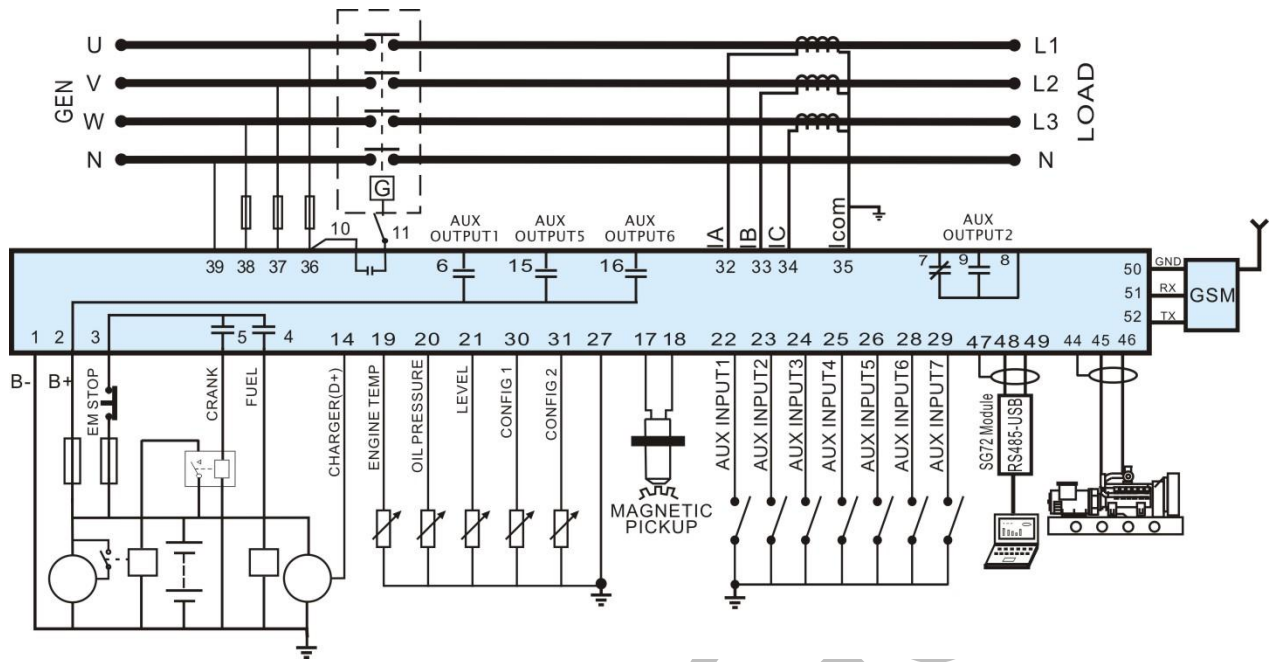

HGM7220CAN typical application diagram

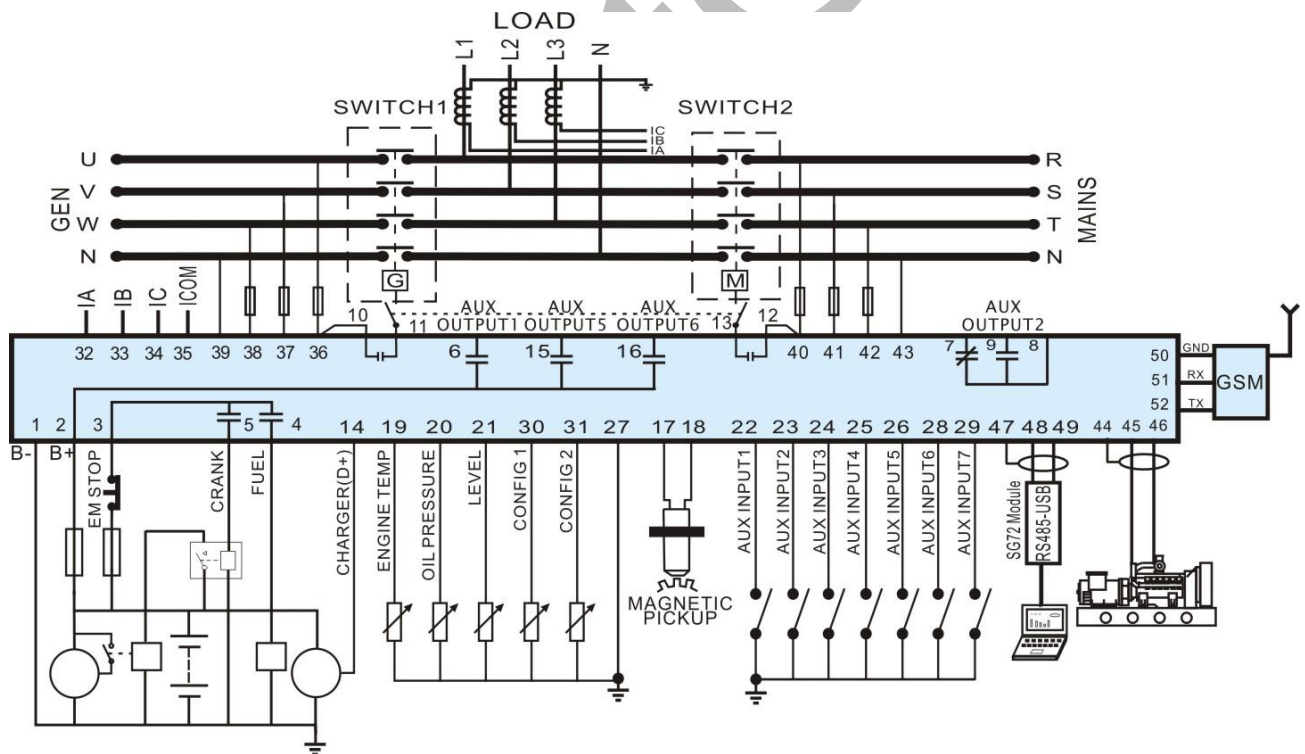

13 INSTALLATION

Controller is panel built-in design; it is fixed by clips when installed. The controller's overall dimensions and cutout dimensions for panel, please refers to as following,

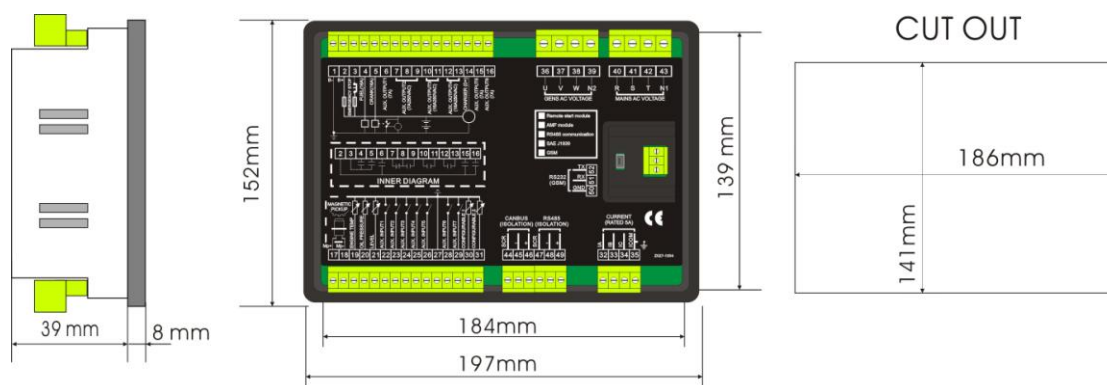

1) Battery Voltage Input

▲NOTE: HGM7200/7100A series controller can suit for widely range of battery voltage (8~35) VDC. Negative of battery must be connected with the shell of starter stable. The diameter of wire which from power supply to battery must be over 2.5mm^2 . If floating charge configured, please firstly connect output wires of charger to battery's positive and negative directly, then, connect wires from battery's positive and negative to controller's positive and negative input ports in order to prevent charge disturbing the controller's normal working.

2) Speed Sensor Input

▲NOTE: speed sensor is the magnetic equipment which be installed in starter and for detecting flywheel teeth. Its connection wires to controller should apply for 2 cores shielding line. The shielding layer should connect with No. 18 terminal in controller while another side is hanging in air. The else two signal wires are connected with No.17 and No.18 terminals in controller. The output voltage of speed sensor should be within (1~24) VAC (effective value) during the full speed. AC12V is recommended (in rated speed). When install the speed sensor, let the sensor is spun to contacting flywheel first, then, port out 1/3 lap, and lock the nuts of sensor at last.

3) Output And Expand Relays

!CAUTION: all outputs of controller are relay contact output type. If need to expand the relays, please add freewheel diode to both ends of expand relay's coils (when

coils of relay has DC current) or, increase resistance-capacitance return circuit (when coils of relay has AC current), in order to prevent disturbance to controller or others equipment.

4) AC Input

Current input of controller must be connected to outside current transformer. And the current transformer's secondary side current must be 5A. At the same time, the phases of current transformer and input voltage must correct. Otherwise, the current of collecting and active power maybe not correct.

▲ NOTE: ICOM port must be connected to negative pole of battery controller power.



WARNING! When there is load current, transformer's secondary side prohibit from open circuit.

5) Withstand Voltage Test

▲ CAUTION! When controller had been installed in control panel, if need the high voltage test, please disconnect controller's all terminal connections, in order to prevent high voltage into controller and damage it.

14 GSM SHORT MESSAGE ALARM AND REMOTE CONTROL

14.1 GSM SHORT MESSAGE ALARM

When controller detects alarm, it will send short message to phone number which be set automatically.

▲ NOTE: All alarms about shutdown, trip and stop and trip will be sent to the pre-set phone. Warning alarms are sent to the phone number according to the set.

14.2 GSM SHORT MESSAGE REMOTE CONTROL

Users send order message to GSM mode, then controller will make actions according to this SMS order and re-back operations information. Controllers only execute the orders by set. Detail orders as following:

No.	SMS Orders	Re-back Information	Description
1	SMS GENSET	GENSET ALARM	When genset is stopping to alarm
		SYSTEM IN STOP MODE GENSET AT standby	At rest status in stop mode
		SYSTEM IN MANUAL MODE GENSET AT REST	At rest status in stop mode
		SYSTEM IN TEST MODE GENSET AT REST	At rest status in stop mode
		SYSTEM IN AUTO MODE GENSET AT REST	At rest status in stop mode
		SYSTEM IN STOP MODE GENSET IS RUNNING	Running status in stop mode
		SYSTEM IN MANUAL MODE GENSET IS RUNNING	Running status in stop mode
		SYSTEM IN TEST MODE GENSET IS RUNNING	Running status in stop mode
		SYSTEM IN AUTO MODE GENSET AT RUNNING	Running status in stop mode
2	SMS START	GENSET ALARM	Generator is shutdown alarm or trip alarm
		STOP MODE NOT START	Cannot start in

			stop mode	
		SMS START OK	Start in manual or auto mode	
		AUTO MODE NOT START	Cannot start in auto mode	
3	SMS STOP MODE	SMS STOP OK	Set as stop mode	
4	SMS MANUAL MODE	SMS MANUAL MODE OK	Set as manual mode	
5	SMS TEST MODE	SMS TEST MODE OK	Set as trial test mode	
6	SMS AUTO MODE	SMS AUTO MODE OK	Set as auto mode	
7	SMS DETAIL	Re-back information can be set via controller software.	Gets details information of genset.	
8	SMS INHIBIT START	INHIBIT START OK	Set as start inhibit	
9	SMS PERMIT START	PERMIT START OK	Set as start permit	

▲ **NOTE:** Its national and area's cods must be added, e.g. Chinese number should be set as 86136666666666.

▲ **NOTE:** When sending orders, users need to follow SMS orders in above form and all the letters must be capital.

▲ **NOTE:** Pass back information from SMS DETAIL including: working mode, mains voltage, generator voltage, load current, mains frequency, generator frequency, active power, apparent power, power factor, battery voltage, D+ voltage, water temperature, oil pressure, oil level, engine speed, total running time, genset status, and alarm status.

15 CONNECTIONS OF CONTROLLER WITH J1939 ENGINE

15.1 CUMMINS ISB/ISBE

Terminals of controller	Connector B	Remark
Fuel relay output	39	
Start relay output	-	Connect with starter coil directly
Auxiliary output port 1	Expand 30A relay, battery voltage of 01,07,12,13 is supplied by relay.	ECU power Set configurable output 1 as "ECU power"

Terminals of controller	9 pins connector	Remark
CAN GND	SAE J1939 shield	CAN communication shielding line(connect to ECU terminal only)
CAN(H)	SAE J1939 signal	Using impedance 120Ω connecting line.
CAN(L)	SAE J1939 return	Using impedance 120Ω connecting line.

Engine type: Cummins ISB

15.2 CUMMINS QSL9

Suitable for CM850 engine control mode

Terminals of controller	50 pins connector	Remark
Fuel relay output	39	
Start relay output	-	Connect to starter coil directly

Terminals of controller	9 pins connector	Remark
CAN GND	SAE J1939 shield-E	CAN communication shielding line(connect to ECU terminal only)
CAN(H)	SAE J1939 signal-C	Using impedance 120Ω connecting line
CAN(L)	SAE J1939 return-D	Using impedance 120Ω connecting line

Engine type: Cummins-CM850

15.3 CUMMINS QSM11 (IMPORT)

It is suitable for CM570 engine control mode. Engine type is QSM11 G1, QSM11 G2.

Terminals of controller	C1 connector	Remark
Fuel relay output	5&8	Outside expand relay, when fuel output, making make port 5 and port 8 of C1 be connected
Start relay output	-	Connect to starter coil directly

Terminals of controller	3 pins data link connector	Remark
CAN GND	C	CAN communication shielding line(connect to ECU terminal only)
CAN(H)	A	Using impedance 120Ω connecting line
CAN(L)	B	Using impedance 120Ω connecting line

Engine type: Cummins ISB

15.4 CUMMINS QSX15-CM570

It is suitable for CM570 engine control module. Engine type is QSX15.

Terminals of controller	50 pins connector	Remark
Fuel relay output	38	Oil spout switch
Start relay output	-	Connect to starter coil directly

Terminals of controller	9 pins connector	Remark
CAN GND	SAE J1939 shield-E	CAN communication shielding line(connect to ECU terminal only)
CAN(H)	SAE J1939 signal-C	Using impedance 120Ω connecting line
CAN(L)	SAE J1939 return-D	Using impedance 120Ω connecting line

Engine type: Cummins QSX15-CM570

15.5 CUMMINS GCS-MODBUS

It is suitable for GCS engine control module. Use RS485-MODBUS to read information of engine. Engine types are QSX15, QST30, QSK23 / 45/60/78 and so on.

Terminals of controller	D-SUB connector 06	Remark
Fuel relay output	5&8	Outside expand relay, when fuel output, connect port 06 and 08 of the connector
Start relay output	-	Connect to starter coil directly

Terminals of controller	D-SUB connector 06	Remark
RS485 GND	20	CAN communication shielding line(connect to ECU terminal only)
RS485+	21	Using impedance 120Ω connecting line
RS485-	18	Using impedance 120Ω connecting line

Engine type: Cummins QSK-MODBUS, Cummins QST-MODBUS, Cummins QSX-MODBUS

15.6 CUMMINS QSM11

Terminals of controller	OEM connector of engine	Remark
Fuel relay output	38	
Start relay output	-	Connect with starter coil directly
CAN GND	-	CAN communication shielding line(connect with controller's this terminal only)
CAN(H)	46	Using impedance 120Ω connecting line
CAN(L)	37	Using impedance 120Ω connecting line

Engine type: common J1939

15.7 CUMMINS QSZ13

Terminals of controller	OEM connector of engine	Remark
Fuel relay output	45	
Start relay output	-	Connect to starter coil directly
Programmable output 1	16&41	Setting to idle speed control, normally open output. Making 16 connect to 41 during high-speed running of controller via external expansion relay.
Programmable output 2	19&41	Setting to pulse raise speed control, normally open output. Making 19 connect with 41 for 0.1s during high-speed warming of controller via external expansion relay.
CAN GND	-	CAN communication shielding line(connect with controller's this terminal only)
CAN(H)	1	Using impedance 120Ω connecting line
CAN(L)	21	Using impedance 120Ω connecting line

Engine type: Common J1939**15.8 DETROIT DIESEL DDEC III / IV**

Terminals of controller	CAN port of engine	Remark
Fuel relay output	Expand 30A relay, battery voltage of 01,07,12,13 is supplied by relay	
Start relay output	-	Connect to starter coil directly
CAN GND	-	CAN communication shielding line(connect to ECU terminal only)
CAN(H)	CAN(H)	Using impedance 120Ω connecting line
CAN(L)	CAN(L)	Using impedance 120Ω connecting line

Engine type: J1939 common used

15.9 DEUTZ EMR2

Terminals of controller	F connector	Remark
Fuel relay output	Expand 30A relay, battery voltage of 01,07,12,13 is supplied by relay. Fuse is 16A	
Start relay output	-	Connect to starter coil directly
-	1	Connect to battery negative pole
CAN GND	-	CAN communication shielding line(connect to ECU terminal only)
CAN(H)	12	Using impedance 120Ω connecting line
CAN(L)	13	Using impedance 120Ω connecting line

Engine type: VolvoEDC4**15.10 JOHN DEERE**

Terminals of controller	21 pins connector	Remark
Fuel relay output	G,J	
Start relay output	D	
CAN GND	-	CAN communication shielding line(connect to ECU terminal only)
CAN(H)	V	Using impedance 120Ω connecting line
CAN(L)	U	Using impedance 120Ω connecting line

Engine type: John Deere**15.11 MTU MDEC**

Suitable for MTU engines, 2000 series, 4000series

Terminals of controller	X1 connector	Remark
Fuel relay output	BE1	
Start relay output	BE9	
CAN GND	E	CAN communication shielding line(connect to ECU terminal only)
CAN(H)	G	Using impedance 120Ω connecting line
CAN(L)	F	Using impedance 120Ω connecting line

Engine type: MTU-MDEC-303

15.12 MTU ADEC(SMART MODULE)

It is suitable for MTU engine with ADEC (ECU8) and SMART module.

Terminals of controller	ADEC (X1port)	Remark
Fuel relay output	X1 10	X1 Terminal 9 Connected to negative of battery
Start relay output	X1 34	X1 Terminal 33 Connected to negative of battery

Terminals of controller	SMART (X4 port)	Remark
CAN GND	X4 3	CAN communication shielding line(connect to controller's this terminal only)
CAN(H)	X4 1	Using impedance 120Ω connecting line
CAN(L)	X4 2	Using impedance 120Ω connecting line

Engine type: MTU-ADEC

15.13 MTU ADEC(SAM MODULE)

It is suitable for MTU engine with ADEC (ECU7) and SAM module.

Terminals of controller	ADEC (X1port)	Remark
Fuel relay output	X1 43	X1 Terminal 28 Connected to negative of battery
Start relay output	X1 37	X1 Terminal 22 Connected to negative of battery

Terminals of controller	SAM (X23 port)	Remark
CAN GND	X23 3	CAN communication shielding line(connect with controller's this terminal only)
CAN(H)	X23 2	Using impedance 120Ω connecting line
CAN(L)	X23 1	Using impedance 120Ω connecting line

Engine type: Common J1939

15.14 PERKINS

It is suitable for ADEM3/ ADEM4 engine control mode. Engine type is 2306, 2506, 1106, and 2806.

Terminals of controller	Connector	Remark
Fuel relay output	1,10,15,33,34	
Start relay output	-	Connect to starter coil directly
CAN GND	-	CAN communication shielding line(connect to ECU terminal only)
CAN(H)	31	Using impedance 120Ω connecting line
CAN(L)	32	Using impedance 120Ω connecting line

Engine type: Perkins

15.15 SCANIA

It is suitable for S6 engine control mode. Engine type is DC9, DC12, and DC16.

Terminals of controller	B1 connector	Remark
Fuel relay output	3	
Start relay output	-	Connect to starter coil directly
CAN GND	-	CAN communication shielding line(connect to ECU terminal only)
CAN(H)	9	Using impedance 120Ω connecting line
CAN(L)	10	Using impedance 120Ω connecting line

Engine type: Scania

15.16VOLVO EDC3

Suitable engine control mode is TAD1240, TAD1241, and TAD1242.

Terminals of controller	“Stand alone” connector	Remark
Fuel relay output	H	
Start relay output	E	
Configurable output 1	P	ECU power Configurable output 1, "ECU power"

Terminals of controller	“Data bus” connector	Remark
CAN GND	-	CAN communication shielding line(connect in ECU this terminal only)
CAN(H)	1	Using impedance 120Ω connecting line
CAN(L)	2	Using impedance 120Ω connecting line

Engine type: Volvo

▲NOTE: When this engine type is selected, preheating time should be set to at least 3 seconds.

15.17VOLVO EDC4

Suitable engine types are TD520, TAD520 (optional), TD720, TAD720 (optional), TAD721, TAD722, and TAD732.

Terminals of controller	Connector	Remark
Fuel relay output	Expanded 30A relay, and relay offers battery voltage to terminal 1.Fuse is 16A	
Start relay output	-	Connect to starter coil directly
	1	Connected to negative of battery
CAN GND	-	CAN communication shielding line(connect to ECU terminal only)
CAN(H)	12	Using impedance 120Ω connecting line
CAN(L)	13	Using impedance 120Ω connecting line

Engine type: VolvoEDC4

15.18 VOLVO-EMS2

Volvo Engine types are TAD734, TAD940, TAD941, TAD1640, TAD1641, and TAD1642.

Terminals of controller	Engine's CAN port	Remark
Configurable output 1	6	ECU stop Configurable output 1 "ECU stop"
Configurable output 2	5	ECU power Configurable output 2 "ECU power"
	3	Negative power
	4	Positive power
CAN GND	-	CAN communication shielding line(connect to ECU terminal only)
CAN(H)	1(Hi)	Using impedance 120Ω connecting line
CAN(L)	2(Lo)	Using impedance 120Ω connecting line

Engine type: Volvo-EMS2

▲ NOTE: When this engine type is selected, preheating time should be set to at least 3 seconds.

15.19 YUCHAI

It is suitable for BOSCH common rail pump engine.

Terminals of controller	Engine 42 pins port	Remark
Fuel relay output	1.40	Connect to engine ignition lock
Start relay output	-	Connect to starter coil directly
CAN GND	-	CAN communication shielding line(connect with controller's this terminal only)
CAN(H)	1.35	Using impedance 120Ω connecting line
CAN(L)	1.34	Using impedance 120Ω connecting line

Battery	Engine 2 pins	Remark
Battery negative	1	Wire diameter 2.5mm ²
Battery positive	2	Wire diameter 2.5mm ²

Engine type: BOSCH

15.20 WEICHAİ

It is suitable for Weichai BOSCH common rail pump engine.

Terminals of controller	Engine port	Remark
Fuel relay output	1.40	Connect to engine ignition lock
Start relay output	1.61	
CAN GND	-	CAN communication shielding line(connect to the controller at this end only)
CAN(H)	1.35	Using impedance 120Ω connecting line
CAN(L)	1.34	Using impedance 120Ω connecting line

Engine type: GTSC1

▲ NOTE: If there is any question of connection between controller and ECU communication, please feel free to contact Smartgen service.

16 FAULT FINDING

Faults	Possible Solutions
Controller no response with power.	Check starting batteries; Check controller connection wirings; Check DC fuse.
Genset shutdown	Check the water/cylinder temperature is too high or not; Check the genset AC voltage; Check DC fuse.
Controller emergency stop	Check emergence stop button is correct or not; Check whether the starting battery positive be connected with the emergency stop input; Check whether the circuit is open.
Low oil pressure alarm after crank disconnect	Check the oil pressure sensor and its connections.
High water temp alarm after crank disconnect	Check the temperature sensor and its connections.
Shutdown Alarm in running	Check related switch and its connections according to the information on LCD; Check programmable inputs.
Crank not disconnect	Check fuel oil circuit and its connections; Check starting batteries; Check speed sensor and its connections; Refer to engine manual.
Starter no response	Check starter connections; Check starting batteries.
Genset running while ATS not transfer	Check ATS; Check the connections between ATS and controllers.
RS485 communication is abnormal	Check connections; Check setting of COM port is correct or not; Check RS485's connections of A and B is reverse connect or not; Check whether damage RS485transfer model; Check whether damage communication port of PC.
ECU communication failed	Check connections of CAN high and low polarity; Check if correctly connected of 120Ω resistor; Check if type of engine correct; Check if connections from controller to engine and setting of inputs correct.
ECU warning or stop	Get information from LCD of alarm page; If there is detailed alarm, check engine according to description. If not, please refer to engine manual according to SPN alarm code.