



SmartGen
ideas for power

HGM8152

Genset Parallel (With Mains) Controller

USER MANUAL



SMARTGEN (ZHENGZHOU) TECHNOLOGY CO., LTD.

CONTENTS

1	OVERVIEW	6
2	PERFORMANCE AND CHARACTERISTICS	6
3	SPECIFICATION.....	8
4	OPERATION	9
4.1	INDICATORS.....	9
4.2	PUSHBUTTONS.....	10
4.3	LCD DISPLAY	11
4.3.1	MAIN DISPLAY	11
4.3.2	PARAMETERS SETTING MENU.....	13
4.3.3	PARAMETER SETTING	13
4.4	AUTO START/STOP OPERATION.....	13
4.5	MANUAL START/STOP OPERATION.....	14
4.6	SWITCH CONTROL PROCEDURES	15
4.6.1	MANUAL CONTROL PROCEDURES	15
4.6.2	AUTOMATIC CONTROL PROCEDURE	16
5	PROTECTIONS	16
5.1	WARNING ALARMS.....	16
5.2	SHUTDOWN ALARMS.....	19
5.3	TRIP AND STOP ALARMS	21
5.4	TRIP ALARM	22
6	WIRING CONNECTION	23
7	SCOPES AND DEFINITIONS OF PROGRAMMABLE PARAMETERS	26
7.1	CONTENTS AND SCOPES OF PARAMETERS.....	26
7.2	DEFINABLE CONTENTS OF PROGRAMMABLE OUTPUT PORTS	37
7.2.1	DEFINED PERIOD OUTPUT	41
7.2.2	DEFINED COMBINATION OUTPUT	42
7.3	DEFINED CONTENTS OF PROGRAMMABLE INPUT PORTS (ALL GROUND CONNECTED (B-) IS ACTIVE)	42
7.4	SELECTION OF SENSORS.....	45
7.5	CONDITIONS OF CRANK DISCONNECT SELECTION	46
8	PARAMETER SETTING	46
9	SENSOR SETTING	47
10	COMMISSIONING	48
10.1	STEP 1: SINGLE UNIT DEBUGGING	48
10.2	STEP 2: MANUAL PARALLEL OPERATION OFF-LOAD	48
10.3	STEP 3: MANUAL PARALLEL OPERATION ON-LOAD.....	48
10.4	STEP 4: AUTOMATIC PARALLEL OPERATION	48
11	MAINS PARALLEL MODE.....	49
11.1	GEN CONTROL MODE	49
11.2	MAINS CONTROL MODE.....	50



11.3	LOAD RECEPTION MODE	51
11.4	AMF CONTROL MODE	52
11.5	ISLAND START MODE	53
12	TYPICAL APPLICATION	54
13	POWER MANAGEMENT MODE	56
14	NEL TRIP ILLUSTRATION	57
15	INSTALLATION	58
15.1	BATTERY VOLTAGE INPUT	58
15.2	SPEED SENSOR INPUT	58
15.3	OUTPUT AND EXPAND RELAYS	58
15.4	AC INPUT	58
15.5	WITHSTAND VOLTAGE TEST	59
16	GSM SHORT MESSAGE ALARM AND REMOTE CONTROL	59
16.1	GSM SHORT MESSAGE ALARM	59
16.2	GSM SHORT MESSAGE REMOTE CONTROL	59
17	CONNECTIONS OF CONTROLLER WITH J1939 ENGINE	61
17.1	CUMMINS ISB/ISBE	61
17.2	CUMMINS QSL9	61
17.3	CUMMINS QSM11 (IMPORT)	61
17.4	CUMMINS QSX15-CM570	62
17.5	CUMMINS GCS-MODBUS	62
17.6	CUMMINS QSM11	63
17.7	CUMMINS QSZ13	63
17.8	DETROIT DIESEL DDEC III / IV	63
17.9	DEUTZ EMR2	64
17.10	JOHN DEERE	64
17.11	MTU MDEC	64
17.12	MTU ADEC (SMART MODULE)	65
17.13	MTU ADEC (SAM MODULE)	65
17.14	PERKINS	65
17.15	SCANIA	66
17.16	VOLVO EDC3	66
17.17	VOLVO EDC4	67
17.18	VOLVO-EMS2	67
17.19	YUCHAI	68
17.20	WEICHAI	68
18	ETHERNET INTERFACE	69
18.1	ETHERNET INTERFACE INTRODUCTION	69
18.2	NETWORK CLIENT MODE	69
18.3	CONTROLLER AND NETWORK CABLE CONNECTION	69
18.3.1	CONTROLLER CONNECT WITH PC WITH A LINE OF CABLE	69
18.3.2	CONTROLLER AND PC CONNECTION VIA SWITCHBOARD (OR ROUTER)	69
19	FAULT FINDING	70



Chinese trademark

SmartGen English trademark

SmartGen —make your generator *smart*

SmartGen Technology Co., Ltd.

No. 28 Jinsuo Road

Zhengzhou City

Henan Province

P. R. China

Tel: 0086-(0)371-67988888/67981888

0086-(0)371-67991553/67992951

0086-(0)371-67981000(overseas)

Fax: 0086-(0)371-67992952

Web: www.smartgen.com.cn

www.smartgen.cn

Email: sales@smartgen.cn

All rights reserved. No part of this publication may be reproduced in any material form (including photocopying or storing in any medium by electronic means or other) without the written permission of the copyright holder.

Applications for the copyright holder's written permission to reproduce any part of this publication should be addressed to SmartGen Technology at the address above.

Any reference to trademarked product names used within this publication is owned by their respective companies.



SmartGen Technology reserves the right to change the contents of this document without prior notice.

Table 1 Software Version

Date	Version	Content
2019-04-24	1.0	Original release
2019-09-10	1.1	Added characteristic description.

This manual is only applicable for HGM8152 Controller.

Table 2 Notation Clarification

Symbol	Instruction
 NOTE	Highlights an essential element of a procedure to ensure correctness.
 CAUTION!	Indicates a procedure or practice, which, if not strictly observed, could result in damage or destruction of equipment.
 WARNING!	Indicates a procedure or practice, which could result in injury to personnel or loss of life if not followed correctly.

SmartGen

1 OVERVIEW

HGM8152 Genset Parallel (with Mains) Controller is especially designed for extremely high/low temperature environment (-40~+70)°C. It applies self-luminous Vacuum Fluorescent Display (VFD) and electronic components with extreme high/low temperature resistance, therefore it can work reliably under extreme temperature condition. After careful consideration for the electromagnetic compatibility on different occasions in designing process, it provides strong guarantee for it to work under complex electromagnetic interference environment. It is plug-in wiring terminal structure, which is convenient to product maintenance and upgrade. Chinese, English, and other various languages can be displayed on controller.

HGM8152 Genset Parallel (with Mains) Controller possesses GOV (Engine Speed Governor) and AVR (Automatic Voltage Regulator) control function, and multiple running modes with Mains parallel. For example, constant active power/reactive power/power factor outputs of genset, mains peak-clipping function, and ceaseless mains supply recover function. This realizes genset automatic start/stop, parallel running, data measurement, alarm protection and "three remotes" functions. Controller can precisely monitor all kinds of working statuses of genset, and when genset is abnormal, controller shall automatically parallel off from the bus, stop the genset, and display fault information. Controller carries SAE J1939 port, which can communicate with multiple ECUs (Engine Control Unit) with J1939 port. It employs 32-bit micro-processor technology, realizing functions of precise measuring for most parameters, set value adjustment, timing and fixed value adjustment etc. Most parameters can be regulated from front panel, and all parameters can be adjusted via USB on PC. And parameters can also be regulated and monitored via RS485 or Ethernet on PC. It has compact structure, simple wiring, high reliability, and can be used widely in various genset automatic parallel system.

2 PERFORMANCE AND CHARACTERISTICS

Main characteristics are as below:

- With ARM-based 32-bit SCM, it has high integration of hardware, and reliability is promoted to a great degree.
- Large screen of graphic dot-matrix VFD, Chinese/English are optional, and can be selected on site, which provides convenience for debugging persons.
- Acrylic material of hard screen for protection, with better wear resisting and scratch resistant performance;
- Silicon panel and button, which makes it have stronger adaptability for high/low environment;
- RS485 communication port, which can realize "three remotes" function with ModBus protocol;
- Ethernet communication port, realizing Ethernet monitoring (it needs to use controller with Ethernet port);
- SMS function, which can automatically send alarm information to pre-set 5 phone numbers when there is alarm occurred, and can also control and check genset status by texts;
- CAN BUS port, which can connect ECU with J1939; this not only can monitor normal data (water temperature, oil pressure, speed, and fuel consumption etc.) of ECU, but also can control start, stop,

- speed raising, and speed dropping etc. via CANBUS port (it needs to use controller with CANBUS port);
- Suitable for (120/240V) power, 50/60Hz system of 3-phase 4-wire, 3-phase 3-wire, single phase 2-wire, 2-phase 3 wire;
 - Collect and display 3-phase voltage, 3-phase current, frequency, and power factor of genset;
 - Collect and display 3-phase voltage, 3-phase current, frequency, and power factor of mains;
 - Complete mains parallel off protection function, over frequency, under frequency, over voltage, under voltage, frequency change ratio, vector change;
 - Detection functions of over voltage, under voltage, over frequency, under frequency, over current, over power, reverse power, loss of phase, reverse phase sequence for genset;
 - 3 fixed analog sensors (temperature, oil pressure, and fuel level);
 - 2 programmable analog sensors can be set to temperature, pressure, or level sensor;
 - Precisely collect all kinds of engine parameters:

Temperature WT	°C/°F display can be selected;
Oil Pressure	kPa/psi/bar display can be selected;
Fuel Level	Unit: %;
Speed	Unit: r/min;
Battery Voltage	Unit: V;
Charger Voltage	Unit: V;
Timer	65535 hours are available;
Accumulated Start Times	max. 65535 times are available;
 - Control protection function: realizing diesel gen set auto start/stop, breaker close/open (switch transfer), and thorough fault display protection functions;
 - All outputs are relay outputs;
 - Parameter setting function: allowing users to change and set parameters, and this will be restored in internal FLASH memory, and will not lose at power outage. A majority of parameters can be adjusted on front panel, and all parameters can be regulated by USB port on PC, or by RS485/Ethernet port on PC;
 - Diverse temperature, voltage, level sensor curves can be used directly and sensor curves can also be users defined;
 - Multiple crank disconnect conditions can be selected (Gen frequency, speed, oil pressure);
 - Power supply range DC(8~35)V, which can suit different starter battery voltage environment;
 - Event Log, Real Time Clock, Scheduled Start/Stop(once per month/week/day, and loading or not can also be set) functions;
 - Can be used as indicating instrument (only indication, alarm and relay doesn't act);
 - Maintenance function, maintenance time due can be set;
 - All parameters are adjusted by digitalization, getting rid of analog adjustment of traditional potentiometer, improving reliability and stability of whole controller;
 - Sealing gasket is designed between enclosure and panel window; waterproof level is IP55;
 - Metal clips are used to fix the controller, which has outstanding performance in high temperature;
 - Modular structure design, pluggable wiring terminal, build-in installation with compact structure and easy mounting features;
 - Accumulated running A and B, Accumulated power A and B; Users can clear up the accumulations, which makes convenience for users to operate by themselves;

3 SPECIFICATION

Table 3 Technical Parameters

Parameter	Details
Working Voltage	DC8. 0V to 35. 0V, continuous power supply
Overall Consumption	<4W (Standby mode: ≤2W)
AC Input:	
3 Phase 4 Wire	AC 15V - 360V (ph-N)
3 Phase 3 Wire	AC 30V - 620V (ph- ph)
Single Phase 2 Wire	AC 15V - 360V (ph-N)
2 Phase 3 Wire	AC 15V - 360V (ph-N)
AC Frequency	50Hz/60Hz
Speed Sensor Voltage	1. 0 V to 24 V (RMS)
Speed Sensor Frequency	Maximum 10,000 Hz
Start Relay Output	16A DC28V power supply output
Fuel Relay Output	16A DC28V power supply output
Flexible Relay Output 1	7A DC28V power supply output
Flexible Relay Output 2	7A DC28V power supply output
Flexible Relay Output 3	7A DC28V power supply output
Flexible Relay Output 4	7A AC250V volts free output
Flexible Relay Output 5	8A AC250V volts free output
Flexible Relay Output 6	8A AC250V volts free output
Case Dimensions	242mm×186mm×53mm
Panel Cutout	214mm×160mm
CT Secondary Current	Rated 5A
Working Conditions	Temperature: (-40~+70)°C Humidity: (20~93)%RH
Storage Conditions	Temperature:(-40~+70)°C
Protection Level	IP55 Gasket: when sealing gasket is installed between enclosure and panel window;
Insulation Intensity	Apply AC2.2kV voltage between high voltage terminal and low voltage terminal and the leakage current is not more than 3mA within 1min.
Weight	0.85kg

4 OPERATION

4.1 INDICATORS

Description for a part of indicators:

Table 4 Alarm Indicators

Alarm Type	Alarm Indicator
No Alarm	Indicator off
Warning	Slow flashing (1 time/s)
Trip Alarm	Slow flashing (1 time/s)
Shutdown Alarm	Fast flashing (5 times/s)
Trip and Stop Alarm	Fast flashing (5 times/s)















Status indicator: illuminates always after crank disconnection before ETS stop, and extinguishes for other periods;



Gen normal indicator: light on always when generating is normal; flashes when generating is abnormal; extinguishes when there is not generating power.

Mains normal indicator: light on always when mains is normal; flashes when mains is abnormal; extinguishes when there is not mains power.

4.2 PUSHBUTTONS

Table 5 Button Description

Icons	Keys	Description
	Stop	Stop the running generator in auto/manual mode; Reset alarm in stop mode; Test panel indicators (lamp test) by pressing over 3s; Stop the genset fast by pressing again in stop process.
	Start	Start the genset in manual mode.
	Manual Mode	Put controller in manual mode.
	Auto Mode	Put controller in auto mode.
	Mute/Reset Alarm	Clear up alarm sound; Reset trip alarm by pressing over 3s if trip (not shutdown) alarm occurred.
	Gen Close/Open	Control generator close/open in manual mode.
	Mains Open/Close	Control mains close/open in manual mode.
	Set/Confirm	Entering setting screen.
	Up/Increase	1) Screen scroll; 2) Move up cursor and increase value in setting menu.
	Down/Decrease	1) Screen scroll; 2) Move down cursor and decrease value in setting menu.
	Left	1) Screen scroll; 2) Left move cursor in setting menu.
	Right	1) Screen scroll; 2) Right move cursor in setting menu.
	Confirm	Confirm inputted content in setting menu.
	Exit	1)Return to main screen; 2) Return to previous menu in setting menu.

NOTE: Press  and  simultaneously in manual mode, and it can force generator to crank. At this time successful start will not be judged according to crank disconnect conditions, operator will have to crank the starter motor manually; when operator decides that the engine has fired, he/she should release the button and start output will be deactivated. Safety on delay will be initiated.

WARNING! Default password is 00318. Users can change it in case others change the advanced parameter settings. Please clearly remember the password after changing. If you forget it, please contact SmartGen services and feedback PD information in controller **ABOUT** page to us.

4.3 LCD DISPLAY

4.3.1 MAIN DISPLAY

Main screen is displayed by pagination.  is used to scroll the pages and  is to scroll the screen.

Main Screen includes the following:

- A part of statuses
- Gen: voltage, frequency
- Load: current, active power, reactive power
- Mains: voltage, frequency
- Engine: speed, temperature, oil pressure

NOTE: Main screens will circularly display if there is not scroll operation.

Status includes the following:

Genset status, switch status, mains status;

Engine includes the following:

Engine speed, engine temperature, engine oil pressure, fuel level, flexible sensor 1, flexible sensor 2, battery voltage, charger voltage, engine accumulated running time, accumulated start times and user A and B accumulated running time;

NOTE: If CAN BUS port is used to read engine information by J1939, this page also includes: coolant pressure, coolant level, fuel temperature, fuel pressure, inlet temperature, exhaust temperature, turbo pressure, fuel consumption, total fuel consumption and so on. Different engines have different parameters displayed.

Generator includes the following:

Phase voltage, line voltage, frequency, phase sequence, each phase current, each phase and total active power (positive and negative), each phase and total reactive power (positive and negative), each phase and total apparent power, each phase and average power factor (positive and negative), accumulated energy, earth current, unbalanced current and user A B accumulated energy.

NOTE: Power factor display illustration:

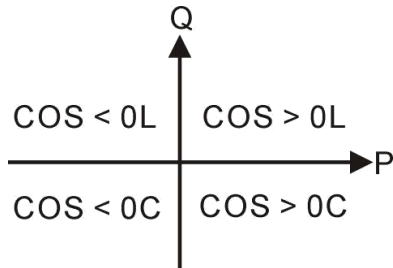

NOTE:

P stands for active power;
Q stands for inactive power.

Table 6 Power Factor Illustration

Power factor	Conditions	Active power	Reactive power	Remark
COS>0L	P>0,Q>0	Input	Input	Load is resistor-inductance;
COS>0C	P>0,Q<0	Input	Output	Load is resistor-capacitance.
COS<0L	P<0,Q>0	Output	Input	Load is equal to an under excitation generator.
COS<0C	P<0,Q<0	Output	Output	Load is equal to an over excitation generator.

NOTE:

1. Input active power, genset or mains sends active power to load.
2. Output active power, load supplies power to generator or mains.
3. Input reactive power, generator or mains sends reactive power to load.
4. Output reactive power, load sends reactive power to generator or mains.

Bus includes the following:

Phase voltage, line voltage, frequency, phase sequence, current, power etc.

SNYC includes the following:

Synchroscope, power percentage etc.

Alarm displays all alarm information, including:

Warning, shutdown alarm, trip shutdown and trip but not shutdown;

NOTE: ECU warning and shutdown alarm illustration: if detailed alarm information is displayed, check the engine based on it; Otherwise, obtain information by checking user manual according to SPN alarm code.

Event log:

Records all start/stop events (shutdown alarm, trip and shutdown alarm, manual/auto start/stop), real time of occurred alarms, and genset parameters;

Others includes:

Time and Date, maintenance due, input/output ports status, network settings etc.

About includes:

Released software and hardware version, product PD number.

4.3.2 PARARMETERS SETTING MENU

Press  key and enter user menu:

Parameter: Input correct password (factory default is 00318) and you can enter parameter setting screen.

Language: Simplified Chinese, English and others are optional (others default: Espanol).

Commissioning: On load, off load or defined commissioning can be selected. On load or off load, commissioning time, after-commissioning mode (manual mode, auto mode, stop mode) can be set for defined commissioning.

Clear users' accumulation: Accumulated running A, accumulated running B, accumulated power A, and accumulated power B can be cleared up.

4.3.3 PARAMETER SETTING

- Mains Set
- Timers set
- Engine set
- Generator set
- Load set
- Breaker set
- Temperature sensor set
- Oil pressure sensor set
- Liquid level sensor sett
- Flexible senor 1
- Flexible senor 2
- Switch input port set
- output port set
- Module set
- Scheduling and maintenance set
- GSM set
- Synchronization set
- Expansion module set

NOTE: press  and parameter setting can exit directly in setting process.

4.4 AUTO START/STOP OPERATION

Press  and indicator beside shall be illuminated, which means genset is in auto start mode.

Automatic Start Sequence:

- 1) When "Remote Start" (on load) is active or mains is abnormal, "Start Delay" timer is initiated;
- 2) "Start Delay" countdown will be displayed on LCD;
- 3) When start delay is over, preheat relay outputs (if configured), and "preheat delay XX s" information will be displayed on LCD;
- 4) After the above delay, the fuel relay (if configured) outputs for 1s, and then the start relay outputs. If crank disconnection doesn't occur in start delay, fuel relay and start relay stops outputting and enter "crank rest time", waiting for next crank;
- 5) During pre-set crank attempts, if crank disconnection doesn't occur, then controller issues "failed to start" signal and stops the genset. "failed to start" alarm shall be displayed on the alarm page of LCD;
- 6) If crank is successful in any of the crank attempts, "safety on" timer is energized. During this period low oil pressure, high temperature, under speed and charge alternator failure alarms are inactive. After this period "start idle" timer is initiated (if configured);
- 7) During "start idle" delay, under speed, under frequency, under voltage alarms are inhibited. When this delay is over, "warming up" delay is initiated (if configured);
- 8) When "warming up delay" is over, if generator is normal, its indicator will be illuminated. If voltage and frequency has reached on-load requirements, the closing relay will be energized, generator will take load, generator power indicator will turn on, and generator will enter normal running state; if voltage and frequency are abnormal, the controller will initiate shutdown alarm (alarm will be displayed on LCD alarm page).

▲NOTE: When genset start is triggered by remote start (off load) input, process is the same as above; the only thing is in procedure 8), close relay doesn't output, and genset doesn't take load.

Automatic Stop Sequence,

- 1) After mains normal delay is over, mains close relay outputs; mains supply indicator is illuminated. When remote start input is inactive and mains is normal, "stop delay" is initiated;
- 2) After "stop delay" has expired, generator close relay opens, gen supply indicator is extinguished. "warming up delay" is initiated;
- 3) "Stop idle delay" (if configured) starts, and idle speed relay is energized;
- 4) "ETS solenoid hold" begins, and ETS relay is energized while fuel relay is de-energized, complete stop is detected automatically;
- 5) "Wait stop delay" begins, and complete stop is detected automatically;
- 6) When generator is stopped completely, "after stop" delay will be initiated. Otherwise, controller enters stop failure, and issues "fail to stop" warning (if generator is stopped successfully after "fail to stop" alarm has initiated, "after stop" delay will be initiated and the alarm will be removed automatically);
- 7) Generator goes to standby mode after "after stop" delay.

4.5 MANUAL START/STOP OPERATION

MANUAL START: Press  and controller enter manual mode. Manual mode indicator is

illuminated. Press  and start the genset, crank disconnection is detected automatically and it goes to high speed running automatically as well. For high temperature, low oil pressure, over speed and

abnormal voltage occasions during generator running, controller can protect genset to stop quickly.

Press  to control breaker close/open. (Please refer to procedure 3)~8) of Automatic Start Sequence for details, only breaker open/close ways are different).

MANUAL STOP: Press  and it can stop the running genset. (Please refer to procedure 2)~7) of Automatic Start Sequence for details.)

NOTE: In manual mode, for breaker close/open procedure please refer to Switch Control Procedure of generator in this manual.

4.6 SWITCH CONTROL PROCEDURES

4.6.1 MANUAL CONTROL PROCEDURES

When controller is in manual mode, switch control process is conducted manually. Breaker close/open is controlled by close/open key.

Gen Close Operation: In normal running process, genset voltage and frequency reaches load requirements and press ,

- when mains is not closed, issue gen close signal directly;
- when mains is already closed, controller shall control GOV and AVR to synchronize genset with mains. When synchronization conditions are satisfied, issue gen close signal, and parallel genset with mains.

Gen Open Operation: Press ,

- when mains is not closed, issue gen open signal directly;
- when mains is closed already, controller firstly transfers load to mains, and then issue gen open signal.

Mains Close Operation: Press mains close key ,

- when gen is not closed, issue mains close signal directly;
- when gen is closed already, controller shall control GOV and AVR to make genset synchronizing with mains. When conditions are met, issue mains close signal, and parallel genset with mains.

Mains Open Operation: Press mains open key ,

- when gen is not closed, issue mains open signal directly;
- when gen is closed already, controller first will transfer load to gen, and then issues mains open signal.

4.6.2 AUTOMATIC CONTROL PROCEDURE

When controller is in auto mode, the switch control procedure is automatic control procedure.

NOTE: Auxiliary input of breaker close must be configured for input port, and wiring must be connected correctly.

5 PROTECTIONS

5.1 WARNING ALARMS

When controller detects warning signals, it only issues warnings, not shutdown the genset.

Table 7 Warning Alarms

No	Type	Description
1	Over Speed	When the controller detects that the engine speed has exceeded the pre-set value, it will initiate a warning alarm.
2	Under Speed	When the controller detects that the engine speed has fallen below the pre-set value, it will initiate a warning alarm.
3	Loss of Speed Signal	When the controller detects that the engine speed is 0 and the action is selected "Warn", it will initiate a warning alarm.
4	Gen Over Frequency	When the controller detects that the genset frequency has exceeded the pre-set value, it will initiate a warning alarm.
5	Gen Under Frequency	When the controller detects that the genset frequency has fallen below the pre-set value, it will initiate a warning alarm.
6	Gen Over Voltage	When the controller detects that the generator voltage has exceeded the pre-set value, the controller will initiate a warning alarm.
7	Gen Under Voltage	When the controller detects that the genset voltage has fallen below the pre-set value, it will initiate a warning alarm.
8	Gen Over Current	When the controller detects that the genset current has exceeded the pre-set value and the action is selected "Warn", it will initiate a warning alarm.
9	Fail To Stop	After "fail to stop" delay, if gen-set does not stop completely, it will initiate a warning alarm.
10	Charge Alternator Failure	When the controller detects that charger voltage has fallen below the pre-set value, it will initiate a warning alarm.
11	Battery Over Volt	When the controller detects that start battery voltage has exceeded the pre-set value, it will initiate a warning alarm.
12	Battery Under Volt	When the controller detects that start battery voltage has fallen below the pre-set value, it will initiate a warning alarm.
13	Maintenance Due	When count down time is 0 and the action is selected "Warn", it will initiate a warning alarm.
14	Reverse Power	When controller detects that the reverse power value (power is negative) has exceeded the pre-set value and the action is selected "Warn", it will initiate a warning alarm.
15	Over Power	When controller detects that the over power value (power is positive)



No	Type	Description
		has exceeded the pre-set value and the action is selected "Warn", it will initiate a warning alarm.
16	ECU Warn	If an error message is received from ECU via J1939, it will initiate a warning alarm.
17	Gen Switch Fail Warn	When gen close status input is not set for input port, it will initiate a warning alarm.
18	Mains Switch Fail Warn	When main close status input is not set for input port, it will initiate a warning alarm.
19	Temperature Sensor Open Circuit	When the controller detects that the temperature sensor is open circuit and the action is selected "Warn", it will initiate a warning alarm.
20	High Temperature	When the controller detects that engine temperature has exceeded the pre-set value, it will initiate a warning alarm.
21	Low Temperature	When the controller detects that engine temperature has fallen below the pre-set value, it will initiate a warning alarm.
22	Oil Pressure Sensor Open Circuit	When the controller detects that the oil pressure sensor is open circuit and the action is selected "Warn", it will initiate a warning alarm.
23	Low Oil Pressure	When the controller detects that the oil pressure has fallen below the pre-set value, it will initiate a warning alarm.
24	Level Sensor Open Circuit	When the controller detects that the level sensor is open circuit and the action is selected "Warn", it will initiate a warning alarm.
25	Low Fuel Level	When the controller detects that the fuel level has fallen below the pre-set value, it will initiate a warning alarm.
26	Flexible Sensor 1 Open Circuit	When the controller detects that the flexible sensor 1 is open circuit and the action is selected "Warn", it will initiate a warning alarm.
27	Flexible Sensor 1 High	When the controller detects that the sensor 1 value has exceeded the pre-set upper limit value, it will initiate a warning alarm.
28	Flexible Sensor 1 Low	When the controller detects that the sensor 1 value has fallen below the pre-set lower limit value, it will initiate a warning alarm.
29	Flexible Sensor 2 Open Circuit	When the controller detects that the flexible sensor 2 is open circuit and the action is selected "Warn", it will initiate a warning alarm.
30	Flexible Sensor 2 High	When the controller detects that the sensor 2 value has exceeded the pre-set upper limit value, it will initiate a warning alarm.
31	Flexible Sensor 2 Low	When the controller detects that the sensor 2 value has fallen below the pre-set lower limit value, it will initiate a warning alarm.
32	Digital Input	When digit input port is set as warning and the alarm is active, it will initiate a warning alarm.
33	GSM Communication Failure	When GSM is active and GSM module isn't detected by the controller, controller will initiate a warning alarm.
34	HMP300 Communication Failure	When HMP300 is enabled, and HMP300 module isn't detected, controller will initiate a warning alarm.
35	Earth Fault	When controller detects that the earth fault current has exceeded the pre-set value and the action is selected "Warn", it will initiate a warning



No	Type	Description
		alarm.
36	Imbalance Current	When imbalance current detection is enabled and controller detects unbalanced current value exceeded pre-set value, the action is selected "Warn", it will initiate a warning alarm.
37	Fail to sync	When the controller does not detect synchronization signal within the pre-set synchronization time, it will initiate a warning alarm.
38	GOV Reach Limit	When GOV output reaches max. value or min. value, controller issues a warning signal.
39	AVR Reach Limit	When AVR output reaches max. value or min. value, controller issues a warning signal.
40	Loss of Excitation	When loss of excitation detection is active and the controller detects that the genset negative reactive power has exceeded the pre-set value, it will initiate a warning alarm.
41	Gen Loss of Phase	When controller detects gen loss of phase, it initiates a warning signal.
42	Gen Phase Seq Wrong	When controller detects gen phase sequence wrong, it initiates a warning signal.
43	Mains Over Freq	When controller detects mains frequency is over pre-set limit, it initiates a warning signal.
44	Mains Under Freq	When controller detects mains frequency is below pre-set limit, it initiates a warning signal.
45	Mains Over Voltage	When controller detects mains voltage is over pre-set limit, it initiates a warning signal.
46	Mains Under Voltage	When controller detects mains voltage is below pre-set limit, it initiates a warning signal.
47	Mains ROCOF	When controller detects mains ROCOF is over pre-set limit, it initiates a warning signal.
48	Mains Vector Shift	When controller detects mains vector change is over pre-set limit, it initiates a warning signal.

5.2 SHUTDOWN ALARMS

When controller detects shutdown alarm, it will send signal to open breaker and shuts down generator immediately.

Table 8 Shutdown Alarms

No	Type	Description
1	Emergency Stop	When the controller detects an emergency stop alarm signal, it will initiate a shutdown alarm.
2	Over Speed	When the controller detects that the generator speed has exceeded the pre-set value, it will initiate a shutdown alarm.
3	Under Speed	When the controller detects that the generator speed has fallen below the pre-set value, it will initiate a shutdown alarm.
4	Loss of Speed Signal	When the controller detects that the engine speed is 0 and the action is selected "Shutdown", it will initiate a shutdown alarm.
5	Gen Over Frequency	When the controller detects that the genset frequency has exceeded the pre-set value, it will initiate a shutdown alarm.
6	Gen Under Frequency	When the controller detects that the genset frequency has fallen below the pre-set value, it will initiate a shutdown alarm.
7	Gen Over Voltage	When the controller detects that the generator voltage has exceeded the pre-set value, the controller will initiate a shutdown alarm.
8	Genset Under Voltage	When the controller detects that the genset voltage has fallen below the pre-set value, it will initiate a shutdown alarm.
9	Fail To Start	If the engine does not fire after the pre-set number of attempts, it will initiate a shutdown alarm.
10	Gen Over Current	When the controller detects that the genset current has exceeded the pre-set value and the action is selected "Shutdown", it will initiate a shutdown alarm.
11	Maintenance Due	When count down time is 0 and the action is selected "Shutdown", it will initiate a shutdown alarm.
12	ECU Shutdown	If an error message is received from ECU via J1939, it will initiate a shutdown alarm.
13	ECU Comm. Fail	If the module does not detect the ECU data via J1939 after engine start, it will initiate a shutdown alarm.
14	Reverse Power	When the controller detects that the reverse power value (power is negative) has exceeded the pre-set value and the action is selected "Shutdown", it will initiate a shutdown alarm.
15	Over Power	When the controller detects that the over power value (power is positive) has exceeded the pre-set value and the action is selected "Shutdown", it will initiate a shutdown alarm.
16	Temperature Sensor Open Circuit	When the controller detects that the temperature sensor is open circuit and the action is selected "Shutdown", it will initiate a shutdown alarm.



No	Type	Description
17	High Temperature	When the controller detects that engine temperature has exceeded the pre-set value, it will initiate a shutdown alarm.
18	Oil Pressure Open Circuit	When the controller detects that the oil pressure sensor is open circuit and the action is selected "Shutdown", it will initiate a shutdown alarm.
19	Low Oil Pressure	When the controller detects that the oil pressure has fallen below the pre-set value, it will initiate a shutdown alarm.
20	Level Sensor Open Circuit	When the controller detects that the level sensor is open circuit and the action is selected "Shutdown", it will initiate a shutdown alarm.
21	Flexible Sensor 1 Open Circuit	When the controller detects that the flexible sensor 1 is open circuit and the action is selected "Shutdown", it will initiate a shutdown alarm.
22	Flexible Sensor 1 High	When the controller detects that the sensor 1 value has exceeded the pre-set upper limit value, it will initiate a shutdown alarm.
23	Flexible Sensor 1 Low	When the controller detects that the sensor 1 value has fallen below the pre-set lower limit value, it will initiate a shutdown alarm.
24	Flexible Sensor 2 Open Circuit	When the controller detects that the flexible sensor 2 is open circuit and the action is selected "Shutdown", it will initiate a shutdown alarm.
25	Flexible Sensor 2 High	When the controller detects that the sensor 2 value has exceeded the pre-set upper limit value, it will initiate a shutdown alarm.
26	Flexible Sensor 2 Low	When the controller detects that the sensor 2 value has fallen below the pre-set lower limit value, it will initiate a shutdown alarm.
27	Digital Input	When digit input port is set as shutdown and the alarm is active, it will initiate a shutdown alarm.
28	Earth Fault	When the controller detects that the earth fault current has exceeded the pre-set value and the action is selected "Shutdown", it will initiate a shutdown alarm.
29	Imbalance Current	When Imbalance Current detection is enabled and the controller detects the imbalanced current has exceeded the pre-set value and the action is selected "Shutdown" it will initiate a shutdown alarm.
30	Gen Phase Sequence Wrong	When the controller detects phase sequence wrong, it will initiate a shutdown alarm.
31	Volt Bus Phase Sequence Wrong	When the controller detects mains phase sequence wrong, it will initiate a shutdown alarm.
32	Volt Bus Error	After synchronized-closing, when the controller detects the voltage difference between generator and bus, it will initiate a shutdown alarm.
33	Loss of Excitation	When loss of excitation is enabled, and the controller detects that the genset negative reactive power has exceeded the pre-set value, it will initiate a shutdown alarm.

5.3 TRIP AND STOP ALARMS

When controller detects trip and stop alarm signal, it immediately disconnects gen close signal, and stops the genset after cooling.

Table 9 Trip and Stop Alarms

No.	Type	Description
1	Gen Over Current	When the controller detects that the genset current has exceeded the pre-set value and the action is selected "Trip and Stop", it will initiate a trip and stop alarm.
2	Maintenance Due	When count down time is 0 and the action is selected "Trip and Stop", it will initiate a trip and stop alarm.
3	Reverse Power	When the controller detects that the reverse power value (power is negative) has exceeded the pre-set value and the action is selected "Trip and Stop", it will initiate a trip and stop alarm.
4	Over Power	When the controller detects that the over power value (power is positive) has exceeded the pre-set value and the action is selected "Trip and Stop", it will initiate a trip and stop alarm.
5	Digital Input	When digit input port is set as "Trip and Stop" and the alarm is active, it will initiate a trip and stop alarm.
6	Earth Fault	When the controller detects that the earth fault current has exceeded the pre-set value and the action is selected "Trip and Stop", it will initiate a trip and stop alarm.
7	Imbalance Current	If earth imbalance current detection is enabled, when the controller detects the imbalance current has exceeded the pre-set value and the action is selected "Trip and Stop", it will initiate a trip and stop alarm.
8	Loss of Excitation	If loss of excitation fault detection is enabled, when the controller detects that the genset negative reactive power has exceeded the pre-set value, it will initiate a trip and stop alarm.
9	Mains Over Freq	When the controller detects that the mains frequency has exceeded the pre-set value, it will initiate a trip and stop alarm.
10	Mains Under Freq	When the controller detects that the mains frequency has fallen below the pre-set value, it will initiate a trip and stop alarm.
11	Mains Over Voltage	When the controller detects that the mains voltage has exceeded the pre-set value, it will initiate a trip and stop alarm.
12	Mains Under Voltage	When the controller detects that the mains voltage has fallen below the pre-set value, it will initiate a trip and stop alarm.
13	Mains ROCOF	When the controller detects that the ROCOF (change rate of frequency) has exceeded the pre-set value, it will initiate a trip and stop alarm.
14	Mains Vector Shift	When the controller detects that vector shift value has exceeded the pre-set value, it will initiate a trip and stop alarm.

5.4 TRIP ALARM

When controller detects trip alarm signal, it immediately disconnects the gen close signal, but genset doesn't stop.

Table 10 Trip Alarms

No.	Type	Description
1	Gen Over Current	When the controller detects that the genset current has exceeded the pre-set value and the action is selected "Trip", it will initiate a trip alarm.
2	Reverse Power	When the controller detects that the reverse power value (power is negative) has exceeded the pre-set value and the action is selected "Trip", it will initiate a trip alarm.
3	Over Power	When the controller detects that the over power value (power is positive) has exceeded the pre-set value and the action is selected "Trip", it will initiate a trip alarm.
4	Digital Input	When digit input port is set as "Trip" and the alarm is active, it will initiate a trip alarm.
5	Earth Fault	When controller detects that the earth fault current has exceeded the pre-set value and the action is selected "Trip", it will initiate a trip alarm.
6	Gen Breaker Fail	When controller detects gen breaker close/open fails, it will initiate a trip alarm.
7	Mains Breaker Fail	When controller detects mains breaker close/open fails, it will initiate a trip alarm.
8	Imbalance Current	If imbalance current detection is enabled, when the controller detects the imbalance current has exceeded the pre-set value and the action is selected "Trip", it will initiate a trip alarm.
9	Loss of Excitation	If loss of excitation fault detection is enabled, when the controller detects that the genset negative reactive power has exceeded the pre-set value, it will initiate a trip alarm.

6 WIRING CONNECTION

Controller back panel is as below:

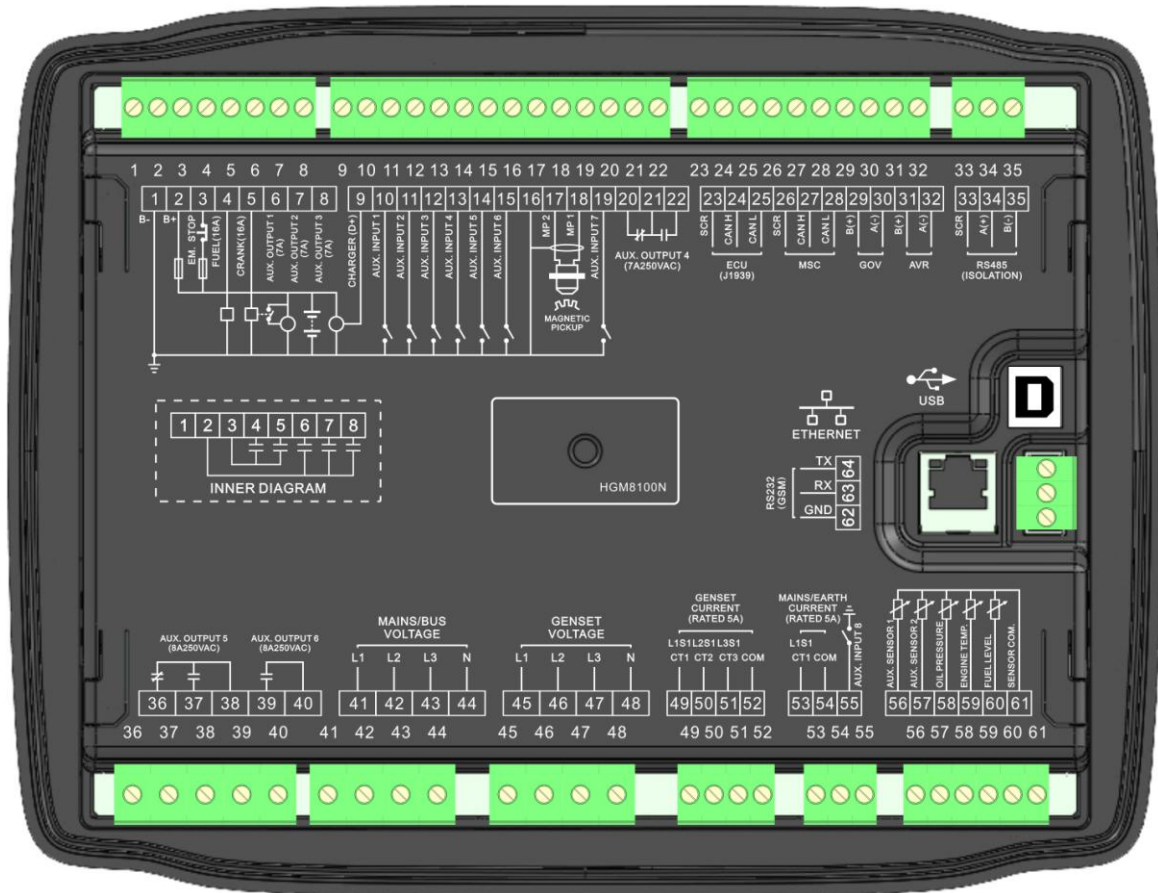

Fig. 1 Controller Back Panel



Table 11 Terminal Connection Description

No.	Functions	Cable Size	Remark	
1	B-	2.5mm ²	Connects negative of starter battery;	
2	B+	2.5mm ²	Connects positive of starter battery. If wire length is over 30m, it's better to double wires in parallel. Max. 20A fuse is recommended.	
3	Emergency stop	2.5mm ²	Connects B+ via emergency stop button;	
4	Fuel relay	1.5mm ²	B+ is supplied by 3 points, rated 16A;	
5	Crank	1.5mm ²	B+ is supplied by 3 points, rated 16A;	Connects starter coil
6	Aux. output 1	1.5mm ²	B+ is supplied by 2 points, rated 7A;	For details please see Table 13.
7	Aux. output 2	1.5mm ²	B+ is supplied by 2 points, rated 7A;	
8	Aux. output 3	1.5mm ²	B+ is supplied by 2 points, rated 7A;	
9	Charger (D+)	1.0mm ²	Connects charger's D+ (WL) terminals. Hung it in the air If there is not this terminal.	
10	Aux. input 1	1.0mm ²	Ground connected is active (B-)	For details please see Table 14.
11	Aux. input 2	1.0mm ²	Ground connected is active (B-)	
12	Aux. input 3	1.0mm ²	Ground connected is active (B-)	
13	Aux. input 4	1.0mm ²	Ground connected is active (B-)	
14	Aux. input 5	1.0mm ²	Ground connected is active (B-)	
15	Aux. input 6	1.0mm ²	Ground connected is active (B-)	
16	Magnetic Pickup	0.5mm ²	Connects with speed sensor, shielding line is recommended. Speed sensor has already connected with (B-) internally.	
17	MP2			
18	MP1			
19	Aux. input 7	1.0mm ²	Ground connected is active (B-)	For details please see Table 14.
20	Aux. output 4	1.5mm ²	Normally close outputs, rated 7A	For details please see Table 13.
21			Public points of relay	
22			Normally open outputs, rated 7A	
23	ECU CAN COM(GND)	/	Impedance-120Ω shielding wire is recommended with single end is ground connected.	
24	ECU CAN H	0.5mm ²		
25	ECU CAN L	0.5mm ²		
26	MSC CAN COM(GND)	/	Reserved	
27	MSC CAN H	0.5mm ²		
28	MSC CAN L	0.5mm ²		
29	GOV B(+)	0.5mm ²	Shielding line is recommended. Shielding layer connects earth at GOV end.	
30	GOV A(-)	0.5mm ²		
31	AVR B(+)	0.5mm ²	Shielding line is recommended. Shielding layer connects earth at AVR end.	
32	AVR A(-)	0.5mm ²		



No.	Functions	Cable Size	Remark	
33	RS485 COM(GND)	/	Impedance-120Ω shielding wire is recommended with single end earth connected.	
34	RS485A(+)	0.5mm ²		
35	RS485B(-)	0.5mm ²		
36	Aux. output 5	2.5mm ²	Normally close outputs, rated 8A	For details please see Table 13.
37		2.5mm ²	Normally open outputs, rated 8A	
38		2.5mm ²	Public points of relay	
39	Aux. output 6	2.5mm ²	Normally open outputs, rated 8A	
40		2.5mm ²	Public points of relay	
41	Mains A-phase voltage input	1.0mm ²	Connects to A-phase of mains(2A fuse is recommended)	
42	Mains B-phase voltage input	1.0mm ²	Connects to B-phase of mains (2A fuse is recommended)	
43	Mains C-phase voltage input	1.0mm ²	Connects to C-phase of mains (2A fuse is recommended)	
44	Mains N-wire input	1.0mm ²	Connects to N-wire of mains	
45	Gen-set A-phase voltage input	1.0mm ²	Connects to A-phase of gen-set (2A fuse is recommended)	
46	Gen-set B-phase voltage input	1.0mm ²	Connects to B-phase of gen-set (2A fuse is recommended)	
47	Gen-set C-phase voltage input	1.0mm ²	Connects to C-phase of gen-set (2A fuse is recommended)	
48	Gen-set N-wire input	1.0mm ²	Connects to N-wire of gen-set	
49	CT A-phase input	1.5mm ²	Outside connects to secondary coil of CT (rated 5A)	
50	CT B-phase input	1.5mm ²	Outside connects to secondary coil of CT (rated 5A)	
51	CT C-phase input	1.5mm ²	Outside connects to secondary coil of CT (rated 5A)	
52	CT COM	1.5mm ²	Refer to following installation instruction;	
53	Mains A-phase	1.5mm ²	Outside connects secondary coil of CT (rated 5A)	
54	current input	1.5mm ²		
55	Aux. Input 8	1.0mm ²	Ground connected is active (B-)	For details please see Table 14.
56	Aux. sensor 1	1.0mm ²	Connects to temperature, oil pressure or fuel level sensors.	For details please see Table 15.
57	Aux. sensor 2	1.0mm ²		
58	Oil pressure	1.0mm ²	Connects to oil pressure sensor.	
59	Engine Temp.	1.0mm ²	Connects to temperature Sensor.	
60	Fuel level	1.0mm ²	Connects to fuel level sensor.	
61	Sensor COM	/	A public terminal of sensor, (B-) has already connected internally.	
62	RS232 COM(GND)	0.5 mm ²	Connects to GSM module;	
63	RS232 RX	0.5 mm ²		
64	RS232 TX	0.5 mm ²		

NOTE1: USB port on back panel is parameter configuration port and can set controller on PC.

NOTE2: Ethernet port on back panel is network monitoring port, and can monitor controller on PC.

7 SCOPES AND DEFINITIONS OF PROGRAMMABLE PARAMETERS

7.1 CONTENTS AND SCOPES OF PARAMETERS

Table 12 Parameter Setting Contents and Range

No.	Items	Range	Defaults	Description
Mains Setting				
1	AC System	(0-3)	0	0: 3P4W; 1: 3P3W; 2: 2P3W; 3: 1P2W;
2	Rated Voltage	(30-30000)V	230	Provide standard for mains over/under voltage detection; it is primary voltage of CT; When AC system is 3P3W, it is wire voltage; for other systems, it is phase voltage;
3	Rated Frequency	(10.0-75.0)Hz	50.0	Provide standard for mains over/under frequency detection;
4	Normal Time	(0-3600)s	10	Check time for mains from abnormal to normal;
5	Abnormal Time	(0-3600)s	5	Check time for mains from normal to abnormal;
6	PT Fitted	(0-1)	0	0: Disable 1: Enable
7	Over Voltage	(0-200)%	120	Rated voltage percentage; return value (default 116%) and delay value (default 5s) can also be set;
8	Under Voltage	(0-200)%	80	Rated voltage percentage; return value (default 84%) and delay value (default 5s) can also be set;
9	Over Frequency	(0-200)%	114	Rated frequency percentage; return value (default 110%) and delay value (default 5s) can also be set;
10	Under Frequency	(0-200)%	90	Rated frequency percentage; return value (default 94%) and delay value (default 5s) can also be set;
11	CT Ratio	(5-6000)/5	500	Ratio of externally connected CT;
12	Full-load Active Power	(1-60000)kW	345	Full-load active power of mains, used for load share;
13	Full-load Reactive Power	(1-60000)kvar	258	Full-load reactive power of mains, used for load share;



No.	Items	Range	Defaults	Description
14	Sync. Alarm	(0-1)	0	0: Electrical Trip 1: Aux. Mains Fail
15	Over Voltage	(0-200)%	105	Rated voltage percentage; alarm action (default: trip and stop) and delay value (default: 0.1s) can also be set;
16	Under Voltage	(0-200)%	95	
17	Over Frequency	(0-200)%	105	Rated frequency percentage; alarm action (default: trip and stop) and delay value (default: 0.1s) can also be set;
18	Under Frequency	(0-200)%	95	
19	ROCOF	(0-1.00)Hz/s	0.20	Set value is ROCOF; alarm action (default: trip and stop) and delay value (default: 0.1s) can also be set;
20	VECTOR	(0-20.0)°	6.0	Set value is Vector Shift; alarm action (default: trip and stop) and delay value (default: 0.1s) can also be set;
Timer Setting				
1	Start Delay	(0~3600)s	5	Time from remote start signal is active to genset start.
2	Stop Delay	(0~3600)s	30	Time from remote start signal is inactive to genset stop.
3	Preheat Delay	(0~3600)s	0	Time of pre-powering heat plug before starter is powered up.
4	Cranking Time	(3~60)s	8	Time of starter powered on
5	Crank Rest Time	(3~60)s	10	The waiting time before second power up when engine start fails.
6	Safety On Delay	(0-3600)s	10	Alarms for low oil pressure, high temperature, under speed, under frequency /voltage, charge fail are inactive.
7	Start Idle Time	(0~3600)s	10	Idle running time of genset at starting.
8	Warming Up Time	(0~3600)s	30	Warming up time between genset close and high speed running.
9	Cooling Time	(0~3600)s	60	Radiating time before genset stop, after genset unloads.
10	Stop Idle Time	(0~3600)s	10	Idle running time at genset stop.
11	ETS Solenoid Hold	(0~3600)s	20	Stop electromagnet's power on time when genset is stopping.
12	Fail to Stop Delay	(0~3600)s	0	Time between ending of genset idle delay and complete stop when "ETS time" is set 0; Time between ending of ETS hold delay and complete stop when "ETS Hold output time" is not 0.
13	After Stop Time	(0~3600)s	0	Time between genset complete stop becoming standby status.



No.	Items	Range	Defaults	Description
Engine Setting				
1	Engine Type	(0~39)	0	Default: Conventional Engine (not J1939); Select the right one when connects J1939;
2	Flywheel Teeth	(10~300)	118	Tooth number of engine flywheel, used for judging starter separation conditions and inspecting engine speed. Refer to following installation instructions.
3	Rated Speed	(0~6000) r/min	1500	Provides standards for judging over/under/loading speed.
4	Loading Speed	(0~100)%	90	Rated speed percentage; Controller detects when it is ready to load. It won't switch on when speed is under loading speed.
5	Loss of Speed Signal	(0~3600)s	5	Time from detecting speed is 0 to confirm the action.
6	Loss of Speed Signal Action	(0~1)	0	0: Warn; 1: Shutdown
7	Over Speed Shutdown	(0~200)%	114	Rated speed percentage; delay value (over speed default: 2s; and under speed default: 3s) also can be set.
8	Under Speed Shutdown	(0~200)%	80	
9	Over Speed Warn	(0~200)%	110	Rated speed percentage, return value (over speed default: 108 and under speed default: 90) and delay value (default: 5s) can also be set.
10	Under Speed Warn	(0~200)%	86	
11	Battery Rated Voltage	(0~60.0)V	24.0	Standard for detecting over/under voltage of battery.
12	Battery Over Volts Alarm	(0~200)%	120	Rated voltage percentage of battery, delay value (default: 60s) and return value (over voltage default: 115 and under voltage default: 90) can also be set.
13	Battery Under Volts Alarm	(0~200)%	85	
14	Charge Alt Fail	(0~60.0)V	8.0	During genset normal running, when charger D+(WL) voltage is lower than this, warning is initiated;
15	Start Attempts	(1~10) times	3	Max. crank times when crank fails. When it is satisfied, controller will send start failure signal.
16	Crank Disconnect	(0~6)	2	Please refer to Table 16. There are 3 conditions of disconnecting starter with engine. Each condition can be used alone or simultaneously for separating the start motor and genset as soon as possible.



No.	Items	Range	Defaults	Description
17	Disconnect Generator Freq	(0~200)%	30	Gen rated frequency percentage; when generator frequency is higher than the set value, starter will be disconnected. Refer to following installation instruction.
18	Disconnect Engine Speed	(0~200)%	30	Rated speed percentage; when generator speed is higher than the set value, starter will be disconnected. Refer to the installation instruction.
19	Disconnect Oil Pressure	(0~1000)kPa	200	When generator oil pressure is higher than the set value, starter will be disconnected. Refer to the installation instruction.
Generator Setting				
1	AC System	(0~3)	0	0: 3P4W; 1: 3P3W; 2: 2P3W; 3: 1P2W.
2	Poles	(2-64)	4	Numbers of generator pole, used for calculating engine speed when there is not speed sensor.
3	Rated Voltage	(30~30000)V	230	Standards for detecting gens over/under voltage and loading voltage. It is also primary voltage when voltage transformer is used.
4	Loading Voltage	(0~200)%	90	Generator rated voltage percentage; it is detected when controller is preparing to take load; when gen voltage is less than loading voltage, it won't enter normal running period;
5	Rated Frequency	(10.0-75.0)Hz	50.0	Standards for detecting over/under/load frequency.
6	Loading Frequency	(0~200)%	90	Gen rated frequency percentage; it is detected when controller is preparing to take load; when gen frequency is less than loading one, it won't enter normal running period;
7	Volt. Trans.(PT)	(0~1)	0	0: Disable; 1:Enable
8	Over Volt. Shutdown	(0~200)%	120	Gen rated volt. Percentage; delay value (default: 3s) can also be set.
9	Under Volt. Shutdown	(0~200)%	80	
10	Over Freq. Shutdown	(0~200)%	114	
11	Under Freq.	(0~200)%	80	Gen rated freq. percentage; Delay value (over frequency default: 2s and under frequency default: 3s) can also be set.



No.	Items	Range	Defaults	Description
	Shutdown			
12	Over Volt. Warn	(0~200)%	110	Gen rated volt. Percentage; delay value (default: 5s) and return value (over volt default: 108 and under volt default: 86) also can be set.
13	Under Volt. Warn	(0~200)%	84	
14	Over Freq. Warn	(0~200)%	110	Gen rated freq. percentage; delay value (default: 5s) and return value (over frequency default: 108 and under frequency default: 86) also can be set.
15	Under Freq. Warn	(0~200)%	84	
Generator Load Setting				
1	Current Trans.	(5~6000)/5	500	Ratio of external CT;
2	Rated Full-load Current	(5~6000)A	500	Generator's rated current, standard of load current.
3	Rated Power	(1-20000)kW	276	Generator's rated power, standard of load power.
4	Overload Current	(0~200)%	120	Rated full-load current percentage of gen; delay value also can be set to definite time limit or inverse time limit.
5	Over Power	(0~200)%	110	Rated active power percentage of generator; delay value (default: 30s) and action (default: trip and stop) can also be set.
6	Reverse Power	(0~200)%	10	Rated active power percentage of generator; delay value (default: 10s) and action (default: trip and stop) can also be set.
7	Earth Fault	(0~1)	0	0: Disable 1: Enable.
8	Imbalance Current	(0~1)	0	0: Disable 1: Enable.
9	Loss of Excitation	(0~200)%	20%	Rated reactive power percentage of generator; delay value (default: 5s) and action (default: trip) can also be set.
Switch Setting				
1	Close Time	(0~20.0)s	5.0	Close pulse width; when it is 0, it means constant output.
2	Open Time	(0~20.0)s	3.0	Open pulse width;
Module Setting				
1	Power On Mode	(0~2)	0	0: Stop mode 1: Manual mode 2: Auto mode
2	Module Address	(1~254)	1	Controller address at remote monitoring;
3	Stop Bit	(0~1)	0	0: 2 stop bits; 1: 1 stop bit



No.	Items	Range	Defaults	Description
4	Language	(0~2)	0	0: Simplified Chinese 1: English 2: Others
5	Password	(0~65535)	00318	For entering parameter setting
6	Temp. Unit Select	(0-1)	0	0: °C 1: °F
7	Pressure Unit Select	(0-2)	0	0: kPa; 1: Psi; 2: Bar.
8	Unparallel Mode Enable	(0-1)	0	0: Disable; 1: Enable
9	Date and Time			Set current date and time.
10	Ethernet Enable	(0~1)	1	0: Disable; 1: Enable All Ethernet setting changes (e.g. IP address, Subnet mask) are active after controller re-power on.
11	HMP300 Enable	(0~1)	0	0: Disable; 1: Enable When it is disabled, mains current and power use module has data themselves; when it is enabled, mains current and power data are read from HMP300 module;
GSM Setting				
1	GSM Enable	(0-1)	0	0: Disable; 1: Enable
2	Phone Number Set	Max. 20 bit		It needs to add area code of region or country; e.g. China 8613666666666
Scheduling And Maintenance Setting				
1	Scheduled Run	(0~1)	0	0: Disable; 1: Enable
2	Scheduled Not Run	(0~1)	0	0: Disable; 1: Enable
3	Maintenance	(0~1)	0	0: Disable; 1: Enable
Analog Sensors Setting				
Temperature Sensor				
1	Curve Type	(0~15)	7	SGX
2	Open Circuit Action	(0~2)	0	0: Warn 1: Shutdown 2: No action
3	High Temp.	(0-300)°C	98	When sensor value is over this value, it



No.	Items	Range	Defaults	Description
	Shutdown			initiates shutdown alarm; it is detected only after safety delay is over; delay value (default: 3s) also can be set.
4	High Temp Warn	(0-300)°C	95	When sensor value is over this value, it initiates warning alarm; it is detected only after safety delay is over; delay value (default: 3s) also can be set.
5	Low Temp. Warn	(0~1)	0	0: Disable; 1: Enable
Oil Pressure Sensor				
1	Curve Type	(0~15)	7	SGX
2	Open Circuit Action	(0~2)	0	0: Warn 1: Shutdown 2: No action
3	Low OP Shutdown	(0~1000)kPa	103	When sensor pressure is lower than this value, it initiates shutdown alarm; it is only detected after safety delay is over; delay value (default: 3s) also can be set.
4	Low OP Warn	(0~1000)kPa	124	When sensor pressure is lower than this value, it initiates warning alarm; it is only detected after safety delay is over; delay value (default: 5s) and return value (default: 138) also can be set.
Fuel Level Sensor				
1	Curve Type	(0~15)	0	Not used.
2	Open Circuit Action	(0~2)	0	0: Warn; 1: Alarm Shutdown; 2: No Action
3	Low Fuel Level Warn	(0~300)%	10	When sensor level is lower than this value, it initiates low warning alarm; it is detected always; delay value (default: 5s) and return value (default: 15) also can be set.
Flexible Sensor 1				
1	Flexible Sensor 1 Setting	(0~3)	0	0: Not Used; 1: Temp. Sensor 2: Pressure Sensor 3: Liquid Level sensor Temp./pressure/level sensors can be set;
Flexible Sensor 2				
1	Flexible Sensor 2 Setting	(0~1)	0	0: Not Used; 1: Temp. Sensor 2: Pressure Sensor



No.	Items	Range	Defaults	Description
				3: Liquid Level sensor Temp./pressure/level sensors can be set;
Digital Input Ports				
Digital Input Port 1				
1	Contents Setting	(0~55)	31	Remote start (demand).
2	Active Type	(0~1)	0	0: Closed to active 1: Open to active
Digital Input Port 2				
1	Contents Setting	(0~55)	27	Low oil pressure shutdown
2	Active Type	(0~1)	0	0: Close 1: Open
Digital Input Port 3				
1	Contents Setting	(0~55)	26	High temperature shutdown
2	Active Type	(0~1)	0	0: Close 1: Open
Digital Input Port 4				
1	Contents Setting	(0~55)	13	Gen close status
2	Active Type	(0~1)	0	0: Close 1: Open
Digital Input Port 5				
1	Contents Setting	(0~55)	0	User defined.
2	Active Type	(0~1)	0	0: Close 1: Open
3	Active Range	(0~3)	3	0: From safety on 1: From starting 2: Always active 3: Deactive
4	Active Actions	(0~4)	4	0: Warn; 1: Shutdown; 2: Trip and stop 3: Trip 4: Indication
5	Delay	(0~20.0)s	2.0	Time from detecting input port is active to confirm.
6	Description			LCD displaying contents when the input is active.
Digital Input Port 6				
1	Contents Setting	(0~55)	44	Reserved
2	Active Type	(0~1)	0	0: Close 1: Open
Digital Input Port 7				
1	Contents Setting	(0~55)	0	User defined



No.	Items	Range	Defaults	Description
2	Active Type	(0~1)	0	0: Close 1: Open
3	Active Range	(0~3)	3	0: From safety on 1: From starting 2: Always active 3: Deactive
4	Active Actions	(0~4)	4	0: Warn; 1: Shutdown; 2: Trip and stop 3: Trip 4: Indication
5	Active Delay	(0~20.0)s	2.0	Time from detecting input port is active to confirm.
6	Description			LCD displaying contents when the input is active.
Digital Input Port 8				
1	Contents Setting	(0-55)	15	Mains close status input;
2	Active Type	(0-1)	0	0: Close 1: Open
Relay Output Ports				
Relay Output Port 1				
1	Contents Setting	(0~299)	44	Generator OK.
2	Output Type	(0~1)	0	0: Normally open; 1: Normally close
Relay Output Port 2				
1	Contents Setting	(0~299)	48	Common Alarm.
2	Output Type	(0~1)	0	0: Normally open; 1: Normally close
Relay Output Port 3				
1	Contents Setting	(0~299)	38	Energize to Stop.
2	Output Type	(0~1)	0	0: Normally open; 1: Normally close
Relay Output Port 4				
1	Contents Setting	(0~299)	35	Idle Control.
2	Output Type	(0~1)	0	0: Normally open; 1: Normally close
Relay Output Port 5				
1	Contents Setting	(0~299)	30	Gen Open Output.
2	Output Type	(0~1)	0	0: Normally open; 1: Normally close
Relay Output Port 6				
1	Contents Setting	(0~299)	29	Gen Close Output.



No.	Items	Range	Defaults	Description
2	Output Type	(0~1)	0	0:Normally open; 1:Normally close
Sync Setting -Basic				
1	Dead Bus Volt	(10-50)V	30	It is considered bus is dead when bus voltage is lower than dead bus voltage.
2	Voltage Difference	(0-30)V	3	It is considered voltage synchronization when the voltage difference between generator and bus is lower than synchronization voltage difference.
3	Positive Freq Difference	(0-2.0)Hz	0.2	It is considered frequency synchronization when the frequency difference between generator and bus is less than positive difference but above negative difference.
4	Negative Freq Difference	(0-2.0)Hz	0.1	
5	Phase Angle Difference	(0-20)°	10	It is considered phase synchronization when the initial phase difference between gen and bus is lower than synchronizing phase angle difference.
6	Difference Frequency	(0-1.00)Hz	0.10	Frequency difference of adjusting gen frequency to be above mains freq.
7	MSC ID	(0-31)	1	Inactive for HGM8152;
8	MSC Priority	(0-31)	0	Inactive for HGM8152;
9	Full-load kW rating	(0-20000)kW	276	Used for load sharing.
10	Full-load kVar rating	(0-20000)kvar	210	Used for load sharing.
11	Baud Rate	(0-3)	1	0: 500 kBit/s; 1: 250 kBit/s; 2: 125 kBit/s; 3: 50 kBit/s.
12	Scheduled Run PCT	(0-100)%	80	Schedule the load value of other genset when start on demand.
13	Scheduled Stop PCT	(0-100)%	50	Schedule the load value of other genset when start on demand.
14	Load Ramp Rate	(0.1-100.0)%/s	3.0	Speed rate(%/s) of genset load/load shedding
15	Load Ramp Point	(0.1-40.0)%	10.0	
16	Load Ramp Delay	(0-30)s	0	
17	Starting Options	(0-1)	1	Inactive for HGM8152;
18	MSC Modules	(1-32)	2	Inactive for HGM8152;
19	MSC Too Few Modules Action Type	(0-2)	1	Inactive for HGM8152;
20	Balance Engine Hours	(1-1000)h	Disable	Inactive for HGM8152;



No.	Items	Range	Defaults	Description
21	Fail to Sync Delay	(5.0-300.0)s	60.0	When the controller doesn't detects Sync. signal during the preset delay, it will send corresponding alarm signal according to the action type. Action Type: 0: Warn 1: Trip
22	Fail to Sync Action	(0-1)	0	
23	NEL Trip Enable	(0-1)	0	0: Disable 1: Enable; For details of function description please refer to the following contents;
24	NEL Trip Value 1	(0-200)%	90	
25	NEL Trip Delay 1	(0-3600)s	5	
26	NEL Trip Value 2	(0-200)%	100	
27	NEL Trip Delay 2	(0-3600)s	1	
28	NEL Auto Reconnection Enable	(0-1)	0	
29	NEL Auto Reconnection Value	(0-200)%	50	
30	NEL Auto Reconnection Delay	(0-3600)s	5	
31	NEL Number	(1-3)	3	
Sync Setting - GOV				
1	Output Type	(0-1)	1	0: Internal Relay output 1: Internal Analog Output
2	Output Reverse	(0-1)	0	0: Disable 1: Enable
3	Loading Action	(0-2)	1	0: None 1: Adjust to Rated Frequency 2: Adjust to Center Point
4	Center Voltage SW1	(0-10.0)	0	Default central voltage: 0V.
5	Voltage Range SW2	(0-10.0)	2.0	Default volt. range: (-1.5~+1.5)V
6	Sync Gain	(0-500) %	20	Adjust and control before paralleling.
7	Sync Stability	(0-2000) %	20	Adjust and control before paralleling.
8	Load Control Gain	(0-500) %	20	Adjust and control after paralleling.
9	Load Control Stability	(0-2000) %	20	Adjust and control after paralleling.
Sync Setting - AVR				
1	Output Type	(0-1)	1	0: Relay output 1: Analog Voltage Output
2	Output Reverse	(0-1)	0	0: Disable 1: Enable.
3	Loading Action	(0-2)	1	0: None



No.	Items	Range	Defaults	Description
				1: Adjust to Rated Frequency 2: Adjust to Center Point
4	Centre Voltage SW1	(0-10.0)	0	Default central voltage: 0V.
5	Voltage Range SW2	(0-10.0)	2.0	Default volt. range: (-1.5~+1.5)V
6	Sync Control Gain	(0-500) %	20	Adjust and control before paralleling.
7	Sync Control Stability	(0-2000) %	20	Adjust and control before paralleling.
8	Load Control Gain	(0-500) %	20	Adjust and control after paralleling.
9	Load Control Stability	(0-2000) %	20	Adjust and control after paralleling.

7.2 DEFINABLE CONTENTS OF PROGRAMMABLE OUTPUT PORTS

Table 13 Definable Contents of Programmable Output Ports

No.	Type	Description
0	Not Used	
1	Custom Period 1	For details of function description please see the following contents.
2	Custom Period 2	
3	Custom Period 3	
4	Custom Period 4	
5	Custom Period 5	
6	Custom Period 6	
7	Custom Combined 1	
8	Custom Combined 2	
9	Custom Combined 3	
10	Custom Combined 4	
11	Custom Combined 5	
12	Custom Combined 6	
13	Pre-set Output	Used for pre-heating control;
14	Reserved	
15	Reserved	
16	Reserved	
17	Air Flap Control	Act at over speed shutdown and emergence stop. It closes the air inflow.
18	Audible Alarm	Act at warning, shutdown, and trips; Can connect an annunciator externally; When "alarm mute" configurable input port is active, it is prohibited to output;
19	Louver Control	Act when genset starts and disconnect when genset has stopped completely;
20	Fuel Pump Control	It is controlled by the upper and lower limits of fuel pump;



No.	Type	Description
21	Heater Control	It is controlled by the upper and lower limits of heating control;
22	Cooler Control	It is controlled by the upper and lower limits of cooling control;
23	Oil Pre-supply Output	Act from crank to safe running periods;
24	Generator Excite	Output in start process. If there is not generator frequency during hi-speed running, it outputs for 2 seconds again.
25	Pre-lubricate	Act from pre-heating to safe running periods.
26	Remote Control Output	This port is controlled by communication (PC).
27	GSM Power Supply	It is used for supply power for GSM module (power off and reset GSM module when GSM fails to communicate);
28	Reserved	
29	Gen Close Output	Control generator to take load.
30	Gen Open Output	Control generator to unload.
31	Mains Close Output	Control mains to take load.
32	Mains Open Output	Control mains to unload;
33	Start Relay	
34	Fuel Relay	Act when genset is starting and disconnect when stop is completed.
35	Idle Control	Used for engine with idle speed; close before starting and open in warming up delay; close during stop idle mode and open when stop is completed.
36	Speed Raise Relay	Act in warming up delay.
37	Speed Drop Relay	Act at stop idle speed and waiting to stop periods;
38	Energize to Stop	Used for engines with ETS electromagnet; close when stop idle is over and open when pre-set "ETS delay" is over.
39	Speed Drop Pulse	Act for 0.1s when controller enters stop idle, used to control part of ECU dropping to idle speed.
40	ECU Stop	Used for ECU engine to control its stop.
41	ECU Power Supply	Used for ECU engine to control its power.
42	Speed Raise Pulse	Act for 0.1s when controller enters warming up delay; used to control part of ECU raising to normal speed.
43	Crank Success	Close when a successful start signal is detected.
44	Generator OK	Act when generator is normal.
45	Generator Load Available	Act in periods of generator ok and hi-speed cooling.
46	Mains normal output	
47	Synchronizing	
48	Common Alarm	Act at genset common warning, common shutdown, common trip alarms.
49	Common Trip and Stop	Act at common trip and stop alarms.
50	Common Shutdown	Act at common shutdown alarms.
51	Common Trip	Act at common trip alarms without stop.
52	Common Warning	Act at common warning alarms.
53	Reserved	



No.	Type	Description
54	Battery Over Voltage	Act at battery's over voltage warning alarms.
55	Battery Under Voltage	Act at battery's low voltage warning alarms.
56	Charge Alternator Failure	Act at charge failure warning alarms.
57	Reserved	
58	Reserved	
59	Reserved	
60	ECU Warning	Indicates ECU sends a warning signal.
61	ECU Shutdown	Indicates ECU sends a shutdown signal.
62	ECU Communication Failure	Indicates controller cannot communicate with ECU.
63	PWM Voltage Raise	
64	PWM Voltage Drop	
65	PWM Speed Raise	
66	PWM Speed Drop	
67	Reserved	
68	Reserved	
69	Digital Input 1 Active	Act when input port 1 is active
70	Digital Input 2 Active	Act when input port 2 is active
71	Digital Input 3 Active	Act when input port 3 is active
72	Digital Input 4 Active	Act when input port 4 is active
73	Digital Input 5 Active	Act when input port 5 is active
74	Digital Input 6 Active	Act when input port 6 is active
75	Digital Input 7 Active	Act when input port 7 is active
76	Digital Input 8 Active	Act when input port 8 is active
77~80	Reserved	
81~96	Extension Digital Input 1-16 Active	Act when extension digital input ports 1-16 are active;
97~98	Reserved	
99	Emergency Stop	Act at emergency stop alarms.
100	Fail To Start	Act at failed start alarms.
101	Fail To Stop	Act at failed stop alarms.
102	Under Speed Warn	Act at under speed alarms.
103	Under Speed Shutdown	Act under speed shuts down alarms.
104	Over Speed Warn	Act at over speed warning alarms.
105	Over Speed Shutdown	Act at over speed shutdown alarms.
106	Reserved	
107	Reserved	
108	Reserved	
109	Gen Over Freq. Warn	Act at generator over frequency warnings.
110	Gen over Freq. Shutdown	Act at generator over frequency shutdown alarms.
111	Gen Over Volt Warn	Act at generator over voltage warnings.
112	Gen Over Volt Shutdown	Act at generator over voltage shutdown alarms.



No.	Type	Description
113	Gen Under Freq. Warn	Act at generator low frequency warnings.
114	Gen Under Freq. Shutdown	Act at generator low frequency shutdown alarms.
115	Gen Under Volt. Warn	Act at generator low voltage warnings.
116	Gen Under Volt. Shutdown	Act at generator low voltage shutdowns.
117	Gen Loss of Phase	Act at generator loss phase alarms.
118	Gen Phase Sequence Wrong	Act at generator reverse phase alarms.
119	Reserved	
120	Over Power Alarm	Act when controller detects generator has over power.
121	Reserved	
122	Generator Reverse Power	Act when controller detects generator has reverse power.
123	Over Current Alarm	Act at over current alarms.
124	Reserved	
125	Mains Inactive	
126	Mains Over Frequency	
127	Mains Over Voltage	
128	Mains Under Frequency	
129	Mains Under Voltage	
130	Mains Phase Sequence Wrong	
131	Mains Loss of Phase	
132~133	Reserved	
134	NEL1 Trip	
135	NEL2 Trip	
136	NEL3 Trip	
137~138	Reserved	
139	High Temp Warn	Act at hi-temperature warnings.
140	Low Temp Warn	Act at low temperature warnings.
141	High Temp Shutdown	Act at hi-temperature Shutdown alarms.
142	Reserved	
143	Low Oil Pressure Warn	Act at low oil pressure warnings.
144	Low Oil Pressure Shutdown	Act at low oil pressure shutdowns.
145	Oil Pressure Open Circuit	Act when oil pressure sensor is open circuit.
146	Reserved	
147	Low Fuel Level	Act when controller has low oil level alarm.
148	Reserved	
149	Reserved	
150	Flexible Sensor 1 High Warn	
151	Flexible Sensor 1 Low Warn	
152	Flexible Sensor 1 High Shut	
153	Flexible Sensor 1 Low Shut	
154	Flexible Sensor 2 High Warn	



No.	Type	Description
155	Flexible Sensor 2 Low Warn	
156	Flexible Sensor 2 High Shut	
157	Flexible Sensor 2 Low Shut	
158~161	Reserved	
162	Expand 1 Sensor 15 High Shutdown	
163	Expand 1 Sensor 15 High Warn	
164	Expand 1 Sensor 15 Low Shutdown	
165	Expand 1 Sensor 15 Low Warn	
166_201	Expand 1 Sensor 16-24	
202~229	Reserved	
230	Stop Mode	Act when system in stop mode.
231	Manual Mode	Act when system in Manual mode.
232	Reserved	
233	Auto Mode	Act when system in Auto mode.
234	Generator Load Indicator	
235	Mains Load Indicator	
236~239	Reserved	
240~279	PLC Flag1~40	Act when PLC is marked as 1;
280~299	Reserved	

7.2.1 DEFINED PERIOD OUTPUT

Defined period output is composed by 2 parts: period output S1 and condition output S2.



While S1 and S2 are **TRUE** synchronously, **OUTPUT**;

While S1 or S2 is **FALSE**, **NOT OUTPUT**.

Period output S1 can be set to one or several period outputs of genset; delay time and output time after entering the periods can be set as well.

Condition output S2 can be any contents of output setting.

▲NOTE: Delay time and output time of period output S1 both are 0, output S1 are true in this period.

For example:

Output period: start

Delay output time: 2s

Output time: 3s

Condition output contents: output port 1 is active

Close when condition output active/inactive: close when active (disconnect when inactive);

When output port 1 is active, and when it enters start period, and delays for 2s, this defined period output starts outputting, and after outputting for 3s, it stops outputting;

When output port 1 is inactive, defined output period doesn't output.

7.2.2 DEFINED COMBINATION OUTPUT

Defined combination output is composed by 3 parts: condition output S1 or S2 and condition output S3.

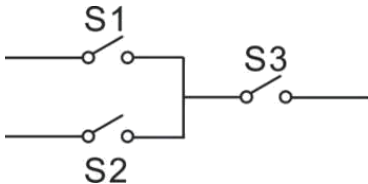

S1 or S2 is **TRUE**, and S3 is **TRUE**, defined combination output is outputting;

S1 and S2 are **FALSE**, or S3 is **FALSE**, defined combination output is not outputting.

ΔNOTE: S1, S2, S3 can be set as any contents except for “defined combination output” in the output settings.

ΔNOTE: 3 parts of defined combination output (S1, S2, S3) couldn't include or recursively include themselves.

For example:

Contents of OR condition output S1: Input port 1 is active;

Close when OR condition output S1 is active /inactive: close when active (disconnect when inactive);

Contents of OR condition output S2, input port 2 is active;

Close when OR condition output S2 is active /inactive: close when active (disconnect when inactive);

Contents of AND condition output S3: Input port 3 is active;

Close when AND condition output S3 is active /inactive: close when active (disconnect when inactive);

When input port 1 active or input port 2 is active, if input port 3 is active, defined combination output is outputting; If input port 3 is inactive, defined combination output is not outputting;



When input port 1 is inactive and input port 2 is inactive, whatever input port 3 is active or not, defined combination output is not outputting.

7.3 DEFINED CONTENTS OF PROGRAMMABLE INPUT PORTS (ALL GROUND CONNECTED (B-) IS ACTIVE)

Table 14 Definable Contents of Programmable Output Ports

No.	Type	Description
0	Users Defined	Users can define the following; Indication: indicate only, not warning or shutdown. Warning: warn only, not shutdown. Shutdown: alarm and shutdown immediately Trip and stop: alarm, generator unload and shutdown after hi-speed cooling; Trip: alarm, generator unload but not shutdown. Never: input is inactive.



No.	Type	Description
		Always: input is active all the time. From crank: detect when crank starts. From safety on: detect after safety on delay.
1	Reserved	
2	Alarm Mute	It can prohibit “Audible Alarm” output when it is active.
3	Alarm Reset	It can reset shutdown alarm and trip alarm when it is active.
4	60Hz Active	Use for ECU engine with CANBUS and it is 60Hz when input is active.
5	Lamp Test	All LED indicators are illuminated when input is active.
6	Panel Lock	All buttons in panel are inactive except  and there is  on the right of first row in LCD Status screen when input is active.
7	War Mode	All shutdown alarms are prohibited except emergency stop and over speed shutdown, and there is also not start idle speed time.
8	Idle Mode	Under voltage/frequency/speed protection is inactive.
9	Auto Stop Inhibit	In Auto mode, during generator normal running, when input is active, generator shutdown is prohibited automatically.
10	Auto Start Inhibit	In Auto mode, generator start is prohibited automatically when input is active.
11	Scheduled Run Inhibit	In Auto mode, fixed time genset start is prohibited when input is active.
12	Reserved	
13	Gen Closed Aux.	Connects aux. point of generator loading switch;
14	Gen Load Inhibit	Genset close is inhibited when input is active.
15	Mains Closed Aux	Connects aux. point of mains loading switch;
16	Mains Load Inhibit	Mains close is inhibited when input is active.
17	Auto Mode Lock	When input is active, controller enters Auto mode; mode keys on the panel are inactive.
18	Auto Mode Inhibit	When input is active, controller won't work under Auto mode and simulate and auto keys does not work.
19	Reserved	
20	Black Start Input	
21	Alarm Stop Inhibit	All shutdown alarms are prohibited except emergence stop.
22	Instrument Mode	All outputs are prohibited in this mode.
23	Non-parallel Mode	
24	Reset Maintenance Alarm	Controller will set maintenance time and date as default when input is active.
25	Reserved	
26	High Temp Shut	Connects sensor digital input.
27	Low Oil Pressure Shut	Connects sensor digital input.
28	Remote Start (On Load)	In Auto mode, when input is active, genset can be started and takes load after genset running normal; when input is inactive, genset will



No.	Type	Description
		stop automatically.
29	Remote Start (Off Load)	In Auto mode, when input is active, genset can be started and takes off load after genset running normal; when input is inactive, genset will stop automatically.
30	Manual Start Aux	In Auto mode, when input is active, genset will start automatically; when input is inactive, genset will stop automatically;
31	Remote Start (On Demand)	In Auto mode, when input is active, genset will start/stop according to load;
32	Remote Start Island	In Auto mode, when input is active, genset will start automatically and takes load after normal running; when input is inactive, mains takes load and genset unloads and stops automatically;
33	Simulate Stop Button	An external button can be connected and pressed as the simulate panel key.
34	Simulate Manual Button	
35	Reserved	
36	Simulate Auto Button	An external button can be connected and pressed as the simulate panel key.
37	Simulate Start Button	
38	Simulate Gen Close/Open Button	
39	Simulate Mains Close/Open Button	
40	NEL Manual Trip	
41	NEL Manual Reconnection	
42	Power Management Mode	
43	Reserved	
44	Reserved	
45	Aux Mains Normal	In Auto mode, when input is active, it means mains is normal;
46	Aux Mains Abnormal	In Auto mode, when input is active, it means mains is abnormal;
47	Alternative Config 1	When input is active, alt. configuration is active; it can be set to different parameters, which is convenient for users to select current configuration (not only by input port).
48	Alternative Config 2	
49	Alternative Config 3	
50	Balance Test	
51	Speed Raise	
52	Speed Drop	
53	Voltage Raise	
54	Voltage Drop	
55	Reserved	

7.4 SELECTION OF SENSORS

Table 15 Sensor Selection

No.		Description	Remark
1	Temperature Sensor	0 Not used 1 Custom Resistance Curve 2 Custom 4-20mA curve 3 VDO 4 CURTIS 5 VOLVO-EC 6 DATCON 7 SGX 8 SGD 9 SGH 10 PT100 11 SUSUKI 12 PRO 13-15 Reserved	Defined resistance's range is (0~6)kΩ.
2	Pressure Sensor	0 Not used 1 Custom Res Curve 2 Custom 4-20mA curve 3 VDO 10Bar 4 CURTIS 5 VOLVO-EC 6 DATCON 10Bar 7 SGX 8 SGD 9 SGH 10 VDO 5Bar 11 DATCON 5Bar 12 DATCON 7Bar 13 SUSUKI 14 PRO 15 Reserved	Defined resistance's range is (0~6)kΩ.
3	Oil Level Sensor	0 Not used 1 Custom Resistance Curve 2 Custom 4-20mA curve 3 SGD 4 SGH 5~15 Reserved	Defined resistance's range is (0~6)kΩ.

NOTE: User should make special declare for order if your genset uses 4~20mA sensor.

7.5 CONDITIONS OF CRANK DINSCONNECT SELECTION

Table 16 Selection of Crank Disconnection Conditions

No.	Setting Contents
0	Gen frequency
1	Speed sensor
2	Speed sensor + Gen frequency
3	Oil pressure
4	Oil pressure + Gen frequency
5	Oil pressure + Speed sensor
6	Oil pressure + Speed sensor + Gen frequency

▲NOTES:

- a) There are 3 conditions to make starter disconnected with engine, that is, speed sensor, generator frequency and engine oil pressure. All of them can be used separately. We recommend that engine oil pressure should be used with speed sensor and generator frequency together, in order to make the starter motor separated with engine immediately and check crank disconnect exactly.
- b) Speed sensor is the magnetic equipment which is installed in starter for detecting flywheel teeth.
- c) When set it speed sensor, users must ensure that the number of flywheel teeth is the same as settings, otherwise, “over speed stop” or “under speed stop” may be caused.
- d) If genset is without speed sensor, please don't select corresponding items, otherwise, “start fail” or “loss speed signal” maybe be caused.
- e) If genset is without oil pressure sensor, please don't select corresponding items.
- f) If generator frequency is not selected in crank disconnect settings, controller will not collect and display the relative power quantity (can be used in water pump set); if speed sensor isn't selected in crank disconnect setting, the rotating speed displayed in controller is calculated by generator frequency and number of poles.

8 PARAMETER SETTING

▲CAUTION! Please change controller parameters when generator is in standby mode (e. g. start conditions selection, configurable input, configurable output, various delay etc.), otherwise shutdown alarm or other abnormal phenomenon may occur. .

▲NOTES:

- 1) Maximum value must be over minimum set value in case that too high and too low may happen at the same time;
- 2) When warning alarm is being set, please set the correct return value; otherwise it may cause abnormal alarms. When maximum value is being set, return value shall be less than the set value; when minimum value is being set, return value must be over set value;
- 3) Please set generator frequency value as low as possible at crank disconnection, aiming to make the starter separated faster as soon as crank is successful;
- 4) Configurable inputs could not be set the same item; otherwise, there may be abnormal functions. However, configurable outputs can be set to the same item.

9 SENSOR SETTING

- When sensor is reselected, sensor curve will be standard value. For example, if temperature sensor is SGX (120°C resistor type) at factory default, sensor curve is SGX (120°C resistor type); if it is selected to SGD (120°C resistor type), then temperature sensor curve is SGD curve.
- If there is difference between standard sensor curve and used sensor, users can adjust it in “curve type” input.
- When sensor curve is inputted, X value (resistor) must be inputted from small to large, otherwise, mistake occurs.
- If sensor type is selected “none”, sensor curve does not work.
- If sensor has alarm switch only, users must set it to “none”, otherwise, there may be shutdown or warning.
- The headmost or backmost values in the vertical coordinates can be set the same as below:

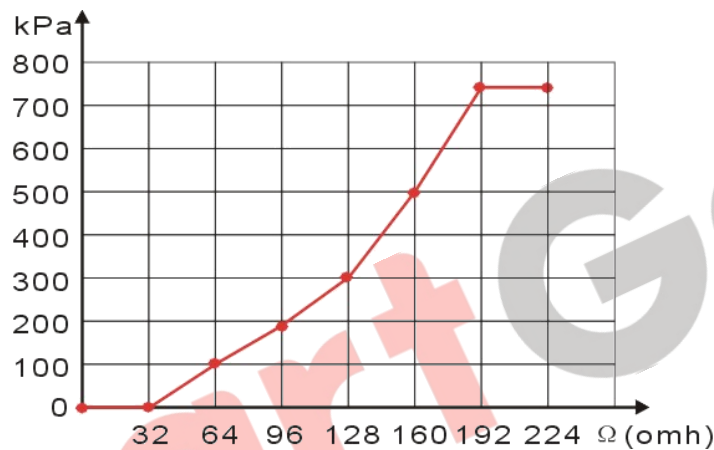

Fig. 2 Curve Settings

Table 17 Normal Pressure Unit Conversion Form

Unit	pa	kgf/cm ²	bar	psi
1Pa	1	1.02x10 ⁻⁵	1x10 ⁻⁵	1.45x10 ⁻⁴
1kgf/cm ²	9.8x10 ⁴	1	0.98	14.2
1bar	1x10 ⁵	1.02	1	14.5
1psi	6.89x10 ³	7.03x10 ⁻²	6.89x10 ⁻²	1

10 COMMISSIONING

10.1 STEP 1: SINGLE UNIT DEBUGGING

- 1) Check parameter configuration of the controller;
- 2) Check gen-set wiring connections;
- 3) For manual start, check if engine and generator data is normal;
- 4) For manual start, check if switch open and close are normal;
- 5) For manual start, check after breaker close if generator frequency can be adjusted to the rated frequency (e.g. set the rated frequency to 52Hz/48Hz);
- 6) For manual start, check after breaker close if generator voltage can be adjusted to the rated voltage (e.g. set the rated voltage to 240V/220V);
- 7) Start genset on load manually, check if power factor, active power and reactive power are normal; if negative value occurs, check generator voltage and current phase sequences, current transformer incoming line direction, secondary current dotted terminal of current transformer;
- 8) For manual start of single unit, do performance test according to national standards.

▲NOTE: Please refer to *HGM9500 Parallel Plan List* for more information on GOV and AVR settings.

10.2 STEP 2: MANUAL PARALLEL OPERATION OFF-LOAD

- 1) Set gen control mode: active power 0%, reactive power 0%;
- 2) Parallel close breakers manually, and check whether genset synchronizing parallel is smooth, and whether impulse current is too large;
- 3) After genset offload parallel, check whether active power, reactive power outputs are 0 or not; if they are not 0, observe whether there is power oscillation; if there is, properly adjust power control gain and stability values, or adjust gain and stability potentiometer of engine GOV or generator AVR to make active power and reactive power not oscillate, and to make output close to 0;

10.3 STEP 3: MANUAL PARALLEL OPERATION ON-LOAD

- 1) Set gen control mode: active power 50%, reactive power 20%;
- 2) After manual parallel, perform soft loading test, and check whether there is very large overshoot or power oscillation; if there is, properly adjust load ramp;
- 3) After manual parallel on load, perform soft unloading test; check whether genset opens after unloading reaches pre-set minimum loading percentage;

10.4 STEP 4: AUTOMATIC PARALLEL OPERATION

- 1) Set gen control mode: active power 50%, reactive power 20%;
- 2) In auto mode, mains is normal; check whether mains breaker closes as usual; when digital input of remote start on load (demand) is active, genset starts automatically to parallel and loads to set power; When digital input of remote start on load (demand) is inactive, genset unloads and stops automatically.

11 MAINS PARALLEL MODE

11.1 GEN CONTROL MODE

Output pre-set active power, reactive power and power factor.

Steady Power Output Mode

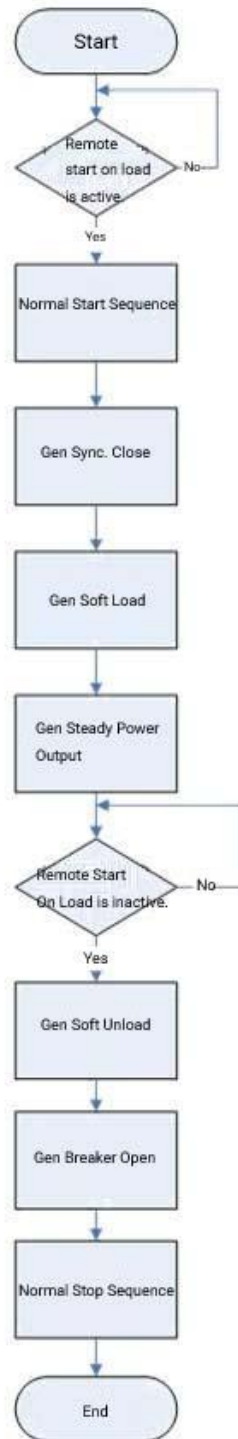

Fig. 3 Steady Power Output Mode

11.2 MAINS CONTROL MODE

Set mains load power value. Gen shall take the surpassing part over pre-set mains power. Mains control mode must be connected with mains CT.

Mains Peak Clipping Mode

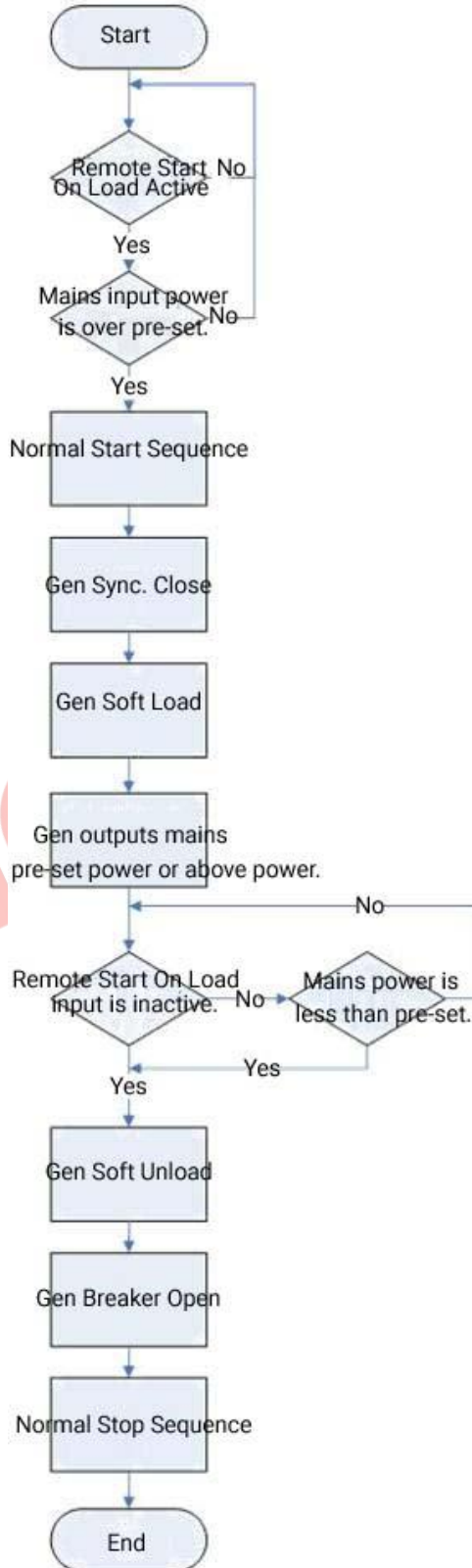

Fig. 4 Mains Peak Clipping Mode

11.3 LOAD RECEPTION MODE

Load reception mode must be connected with mains CT.

Load Reception Mode

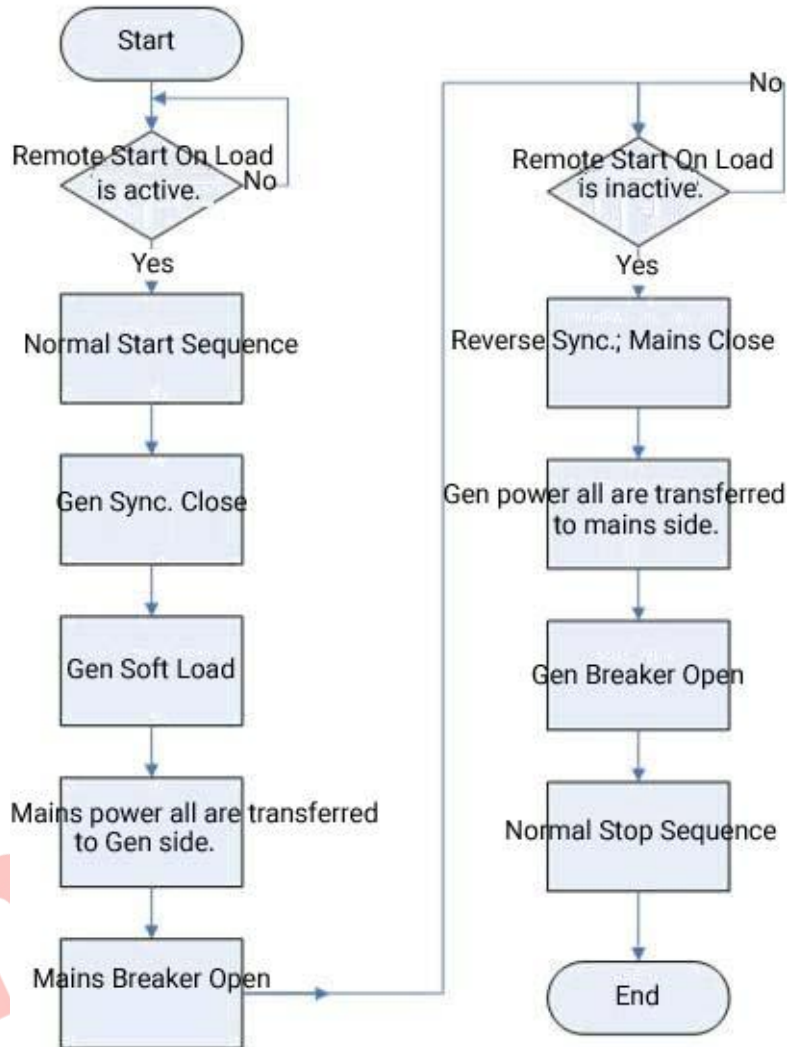

Fig. 5 Load Reception Mode

11.4 AMF CONTROL MODE

Automatic mains inactive start mode.

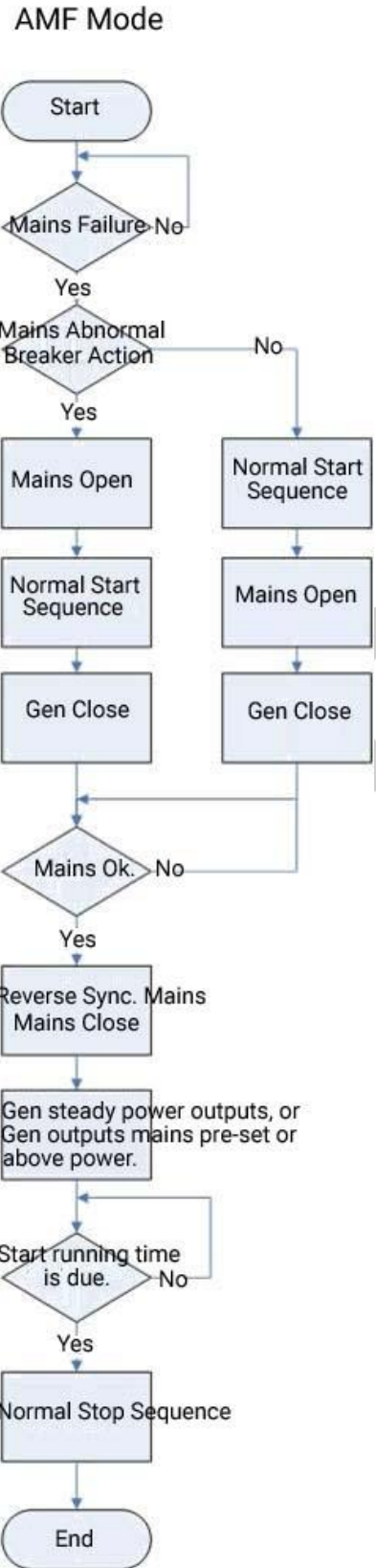

Fig. 6 AMF Mode

11.5 ISLAND START MODE

Island Output Mode

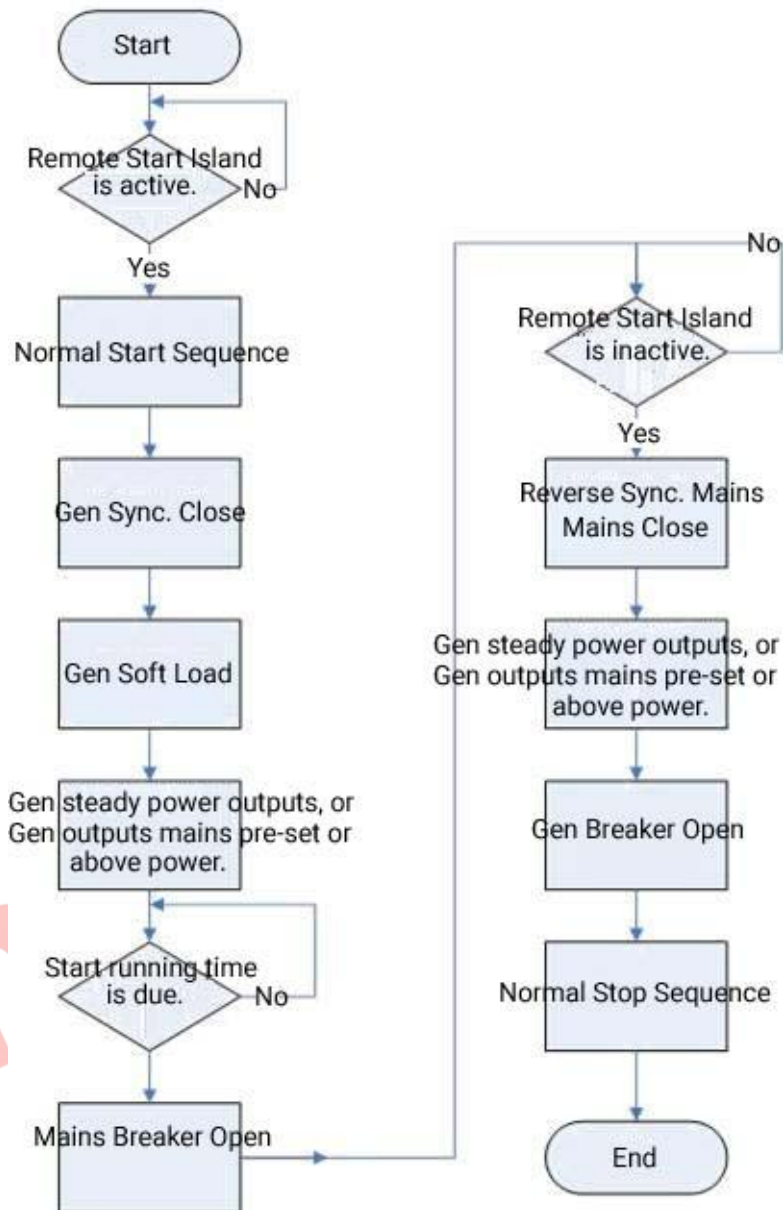

Fig. 7 Island Output Mode

12 TYPICAL APPLICATION

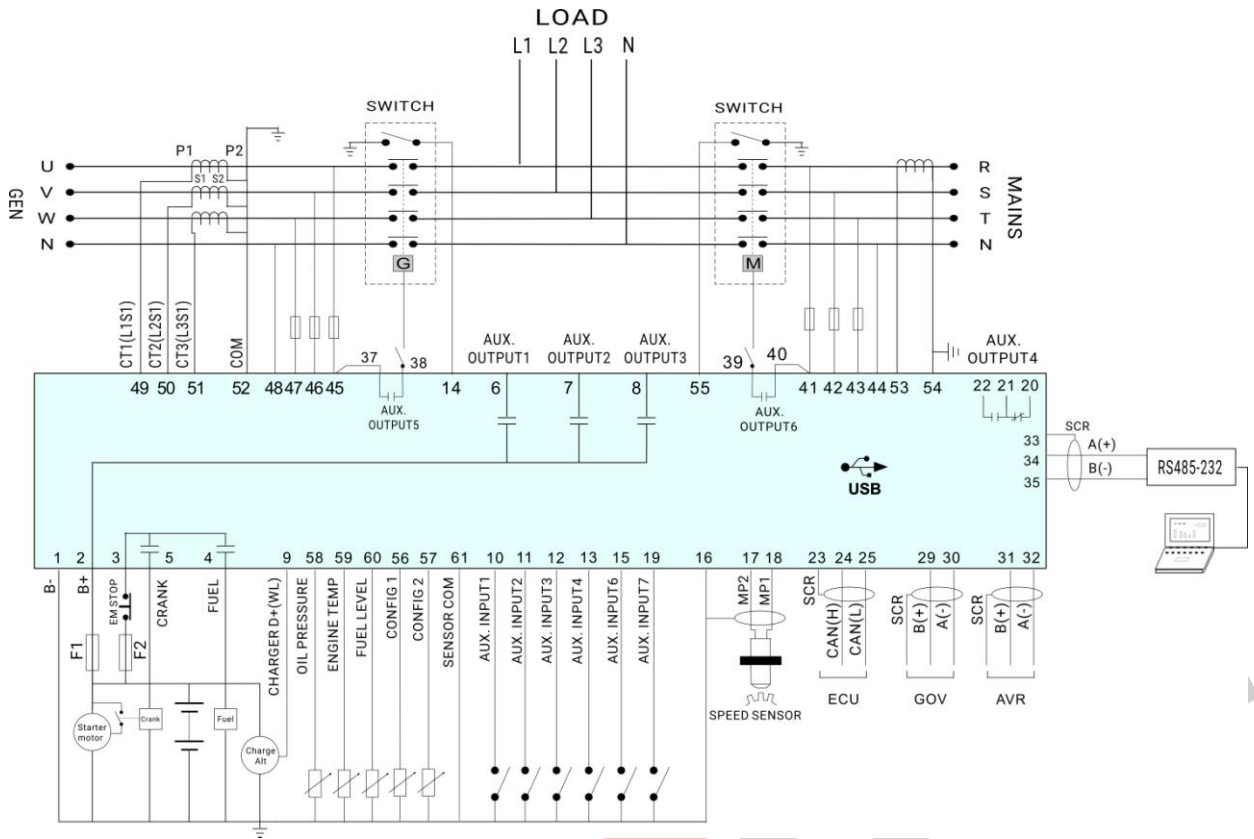

Fig. 8 HGM8152 3P4W Typical Diagram

NOTE: Fuse F1: min. 2A; max. 20A; Fuse F2: max. 32A. Users should select suitable fuse depending on practical application.

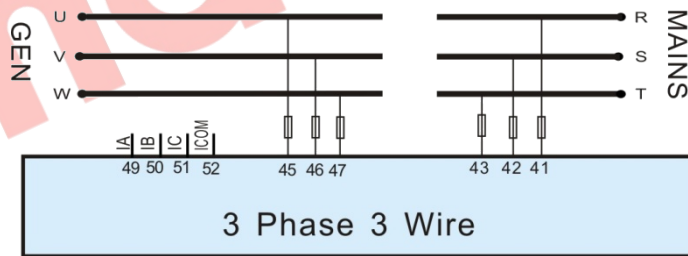

Fig. 9 HGM8152 3 Phase 3 Wire Typical Diagram

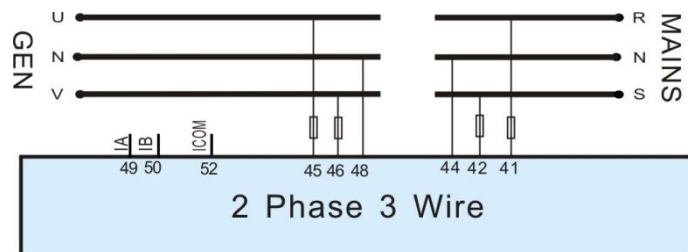

Fig. 10 HGM8152 2 Phase 3 Wire Typical Diagram

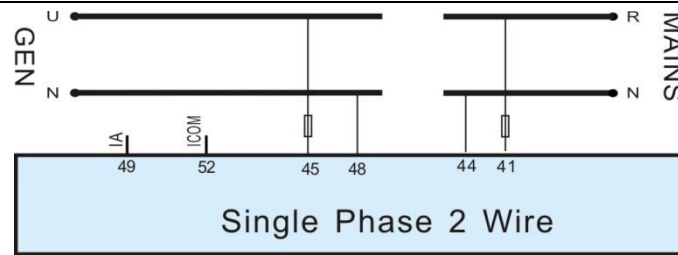

Fig. 11 HGM8152 Single Phase 2 Wire Typical Diagram

NOTE: HGM8152 can realize parallel function with mains by a programmable input port. Under mains parallel mode, gen is in parallel with mains. Genset can only output steady power (load mode is set to gen control mode).

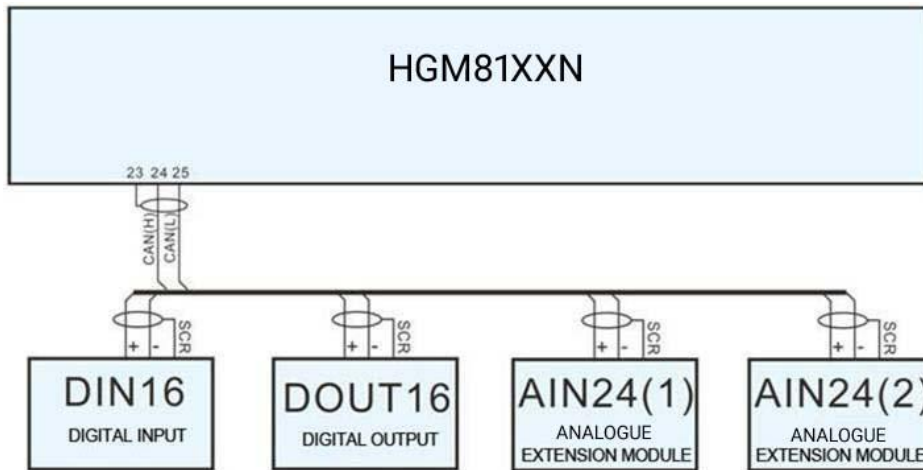

Fig. 12 HGM8152 Extension Module Typical Diagram

13 POWER MANAGEMENT MODE

Power management mode can be selected via a configurable input port.

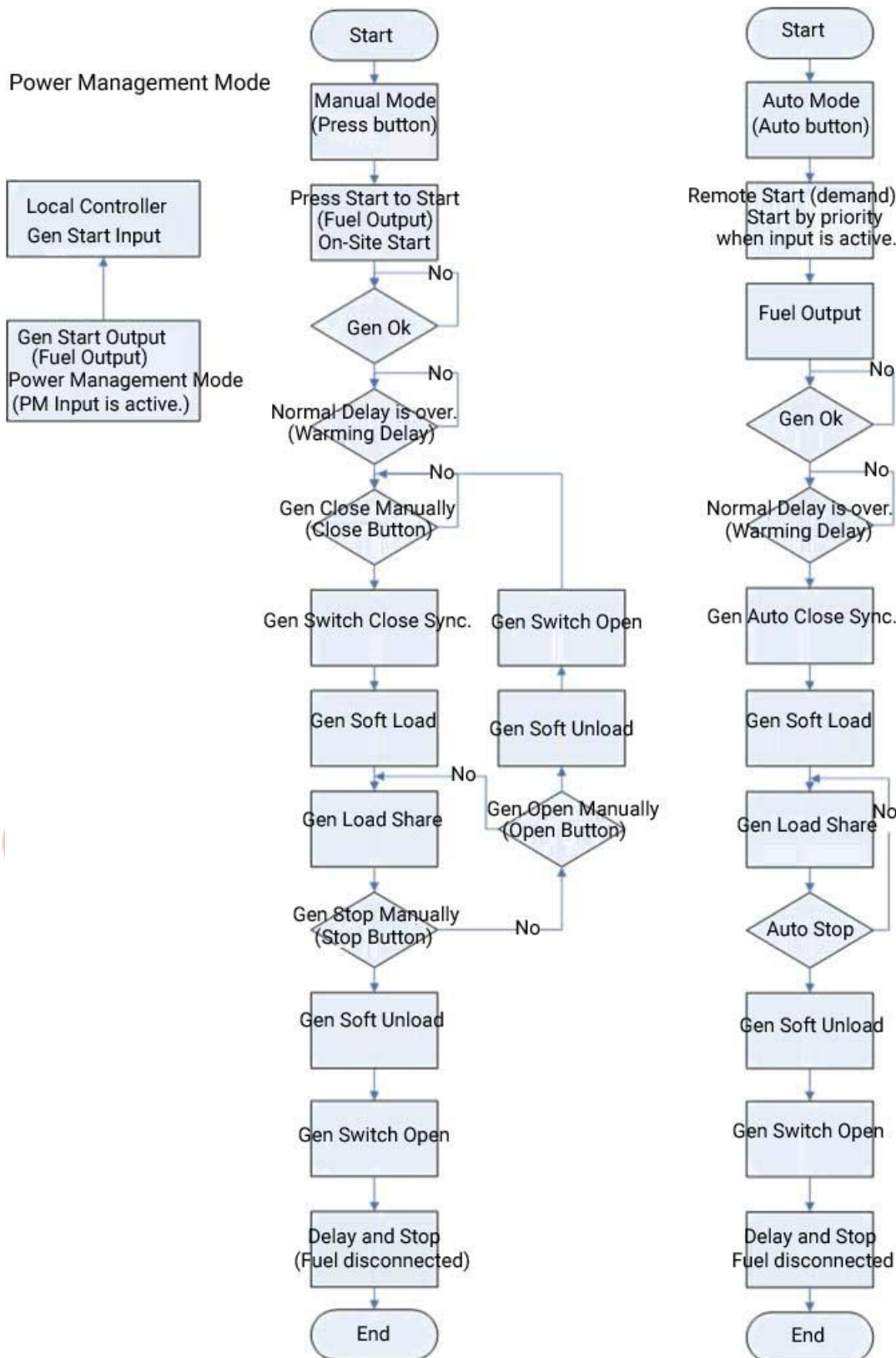

Fig. 13 Power Management Mode Flow Chart

14 NEL TRIP ILLUSTRATION

Non-Essential Load ---- is NEL for short.

The controller can control NEL1, NEL2 and NEL3 to trip separately. The order of the essentiality is: NEL3 > NEL2 > NEL1.

Auto Trip:

- When NEL auto trip is enabled: If genset power has exceeded NEL trip value, after trip delay NEL1 will trip for the earliest, and next is NEL2, NEL3;
- When NEL auto reconnection is enabled: If genset power has fallen below the auto reconnection set value, after the auto reconnection delay NEL3 will be reconnected for the earliest, and next is NEL2, NEL1;

t1: NEL Trip Delay
t2: Reconnection Delay

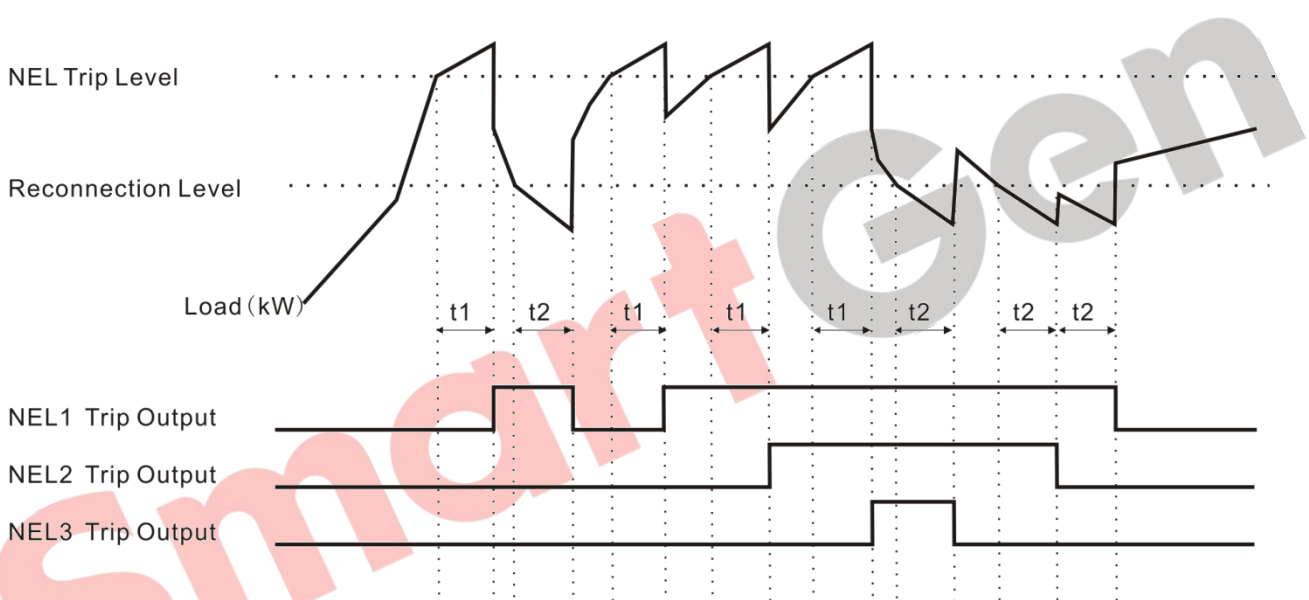

Fig. 14 NEL Trip Diagram

Manual Trip

- If NEL manual trip input is active (falling edge is active), NEL1 will trip without delay; If NEL manual trip input is active again, NEL2 will trip; If NEL manual trip input is active for the third time, NEL3 will trip. During this process, the controller does not detect if the genset power has exceeded the NEL trip value or not.
- If NEL manual reconnection input is active (falling edge is active), NEL3 will be reconnected without delay; If NEL manual reconnection input is active again, NEL2 will reconnect; If NEL manual reconnection input is active for the third time, NEL1 will reconnect. During this process, the controller detects the genset power: if the genset power has fallen below the NEL reconnection value, then the input is active; if it doesn't, the input is deactivated.

▲NOTE: When auto trip and auto reconnection are enabled, manual trip is still active.

15 INSTALLATION

Controller is panel built-in design and it is fixed by clips when installed. The controller overall dimensions and cutout size are as below:

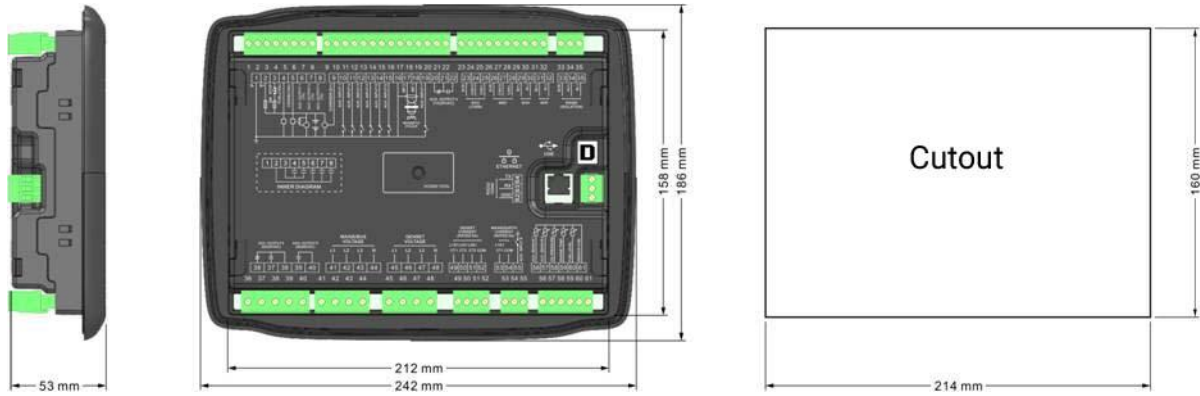

Fig. 15 Case Dimensions and Cutout

15.1 BATTERY VOLTAGE INPUT

HGM8152 controller suits wide range battery voltage (8~35) VDC. Negative of battery must be connected with the shell of starter. The wire diameter of connecting B+ and B- with battery negative and positive must not be less than 2.5mm². If floating charger is installed, please firstly connect output wires of charger to battery's positive and negative directly, then connect wires from battery's positive and negative to controller power input terminals in order to prevent charger disturbing the controller's normal working.

15.2 SPEED SENSOR INPUT

Speed sensor is the magnetic equipment installed in starter and for detecting teeth of flywheel. Its connection wires to controller should apply 2 cores shielding line. The shielding layer should connect to terminal 16 in controller while another side shall hang up in air. The other two signal wires are connected to No.17 and No.18 terminals in controller. The output voltage of speed sensor should be within AC(1~24)V (effective value) during the full speed. AC12V is recommended (at rated speed). When speed sensor is installed, let the sensor spun to contacting flywheel first, then port out 1/3 lap, and lock the nuts of sensor at last.

15.3 OUTPUT AND EXPAND RELAYS

CAUTION! All outputs of controller are relay contact outputs. If it needs to expand relays, please add freewheel diode to both ends of expansion relay coils (when coils of relay has DC current) or, increase resistance-capacitance return circuit (when coils of relay has AC current), in order to prevent disturbance to controller or other equipments.

15.4 AC INPUT

Current input must be connected to outside current transformer. Current transformer's secondary side current must be 5A. At the same time, phases of current transformer and input voltage must be correct, otherwise collected current and active power may not be correct.

NOTE: ICOM port must be connected to negative pole of battery.



WARNING! When there is load current, transformer's secondary side is prohibited to open circuit.

15.5 WITHSTAND VOLTAGE TEST

CAUTION! When controller has been installed in control panel, if high voltage test is needed, please disconnect controller's all terminal connections, in order to prevent high voltage entering controller and damaging it.

16 GSM SHORT MESSAGE ALARM AND REMOTE CONTROL

16.1 GSM SHORT MESSAGE ALARM

When controller detects alarms, it will send short messages to pre-set phone automatically.

NOTE: All alarms, shutdown, trip and stop and trip will send messages to pre-set phone. Warnings are sent to the phone according to the users pre-set.

16.2 GSM SHORT MESSAGE REMOTE CONTROL

Users send order message to GSM module, then controller will make actions according to this SMS order and pass back corresponding operation information. Controller only executes the orders pre-set. Detailed order messages are as below:



Table 18 SMS Order List

No.	SMS Orders	Pass back Information	Description
1	SMS GENSET	GENSET ALARM	Stop alarms
		SYSTEM IN STOP MODE GENSET AT REST	Standby status in stop mode
		SYSTEM IN MANUAL MODE GENSET AT REST	Standby status in manual mode
		SYSTEM IN AUTO MODE GENSET AT REST	Standby status in auto mode
		SYSTEM IN STOP MODE GENSET IS RUNNING	Running status in stop mode
		SYSTEM IN MANUAL MODE GENSET IS RUNNING	Running status in manual mode
		SYSTEM IN AUTO MODE GENSET AT RUNNING	Running status in stop mode
2	SMS START	GENSET ALARM	Shutdown alarm or trip alarm
		STOP MODE NOT START	Cannot start in stop mode
		SMS START OK	Start in manual mode
		AUTO MODE NOT START	Cannot start in auto mode
3	SMS STOP MODE	SMS STOP OK	Set as stop mode
4	SMS MANUAL MODE	SMS MANUAL MODE OK	Set as manual mode
5	SMS AUTO MODE	SMS AUTO MODE OK	Set as auto mode
6	SMS DETAIL	Pass back information can be set via controller software.	Gets detailed information of genset.
7	SMS INHIBIT START	INHIBIT START OK	Set as inhibit start
8	SMS PERMIT START	PERMIT START OK	Remove inhibit boot

NOTE1: National or area codes must be added on the phone number; e.g. China: 8613666666666.

NOTE2: Information shall be sent as exactly as the table contents and letters shall be capitalized.

NOTE3: Details of Pass back information from SMS DETAIL includes: working mode, mains voltage, generator voltage, load current, mains frequency, generator frequency, active power, apparent power, power factor, battery voltage, D+ voltage, water temperature, oil pressure, fuel level, engine speed, total running time, genset status, and alarm status.

17 CONNECTIONS OF CONTROLLER WITH J1939 ENGINE

17.1 CUMMINS ISB/ISBE

Table 19 Connector B

Terminals of controller	Connector B	Remark
Fuel relay output	39	
Start relay output	-	Connect with starter coil directly
Auxiliary output port 1	Expand 30A relay, battery voltage of 01,07,12,13 is supplied by relay	ECU power Set configurable output 1 as "ECU power"

Table 20 9-pin Connector

Terminals of controller	9 pins connector	Remark
CAN GND	SAE J1939 shield	CAN communication shielding line(connect with ECU terminal only)
CAN(H)	SAE J1939 signal	Impedance 120Ω connecting line is recommended.
CAN(L)	SAE J1939 return	Impedance 120Ω connecting line is recommended.

Engine type: Cummins ISB

17.2 CUMMINS QSL9

Suitable for CM850 engine control module.

Table 21 50-pin Connector

Terminals of controller	50 pins connector	Remark
Fuel relay output	39	
Start relay output	-	Connect to starter coil directly

Table 22 9-pin Connector

Terminals of controller	9 pins connector	Remark
CAN GND	SAE J1939 shield-E	CAN communication shielding line(connect with ECU terminal only)
CAN(H)	SAE J1939 signal-C	Using impedance 120Ω connecting line
CAN(L)	SAE J1939 return-D	Using impedance 120Ω connecting line

Engine type: Cummins-CM850

17.3 CUMMINS QSM11(IMPORT)

It is suitable for CM570 engine control module. Engine type is QSM11 G1, QSM11 G2.

Table 23 C1-pin Connector

Terminals of controller	C1 connector	Remark
Fuel relay output	5&8	Outside expand relay, when fuel output, making port 5 and port 8 of C1 connected
Start relay output	-	Connect to starter coil directly

Table 24 3-pin Data Link Connector

Terminals of controller	3 pins data link connector	Remark
CAN GND	C	CAN communication shielding line(connect with ECU terminal only)
CAN(H)	A	Using impedance 120Ω connecting line
CAN(L)	B	Using impedance 120Ω connecting line

Engine type: Cummins ISB

17.4 CUMMINS QSX15-CM570

It is suitable for CM570 engine control module. Engine type is QSX15.

Table 25 50-pin Connector

Terminals of controller	50 pins connector	Remark
Fuel relay output	38	Oil spout switch
Start relay output	-	Connect to starter coil directly

Table 26 9-pin Connector

Terminals of controller	9 pins connector	Remark
CAN GND	SAE J1939 shield-E	CAN communication shielding line(connect with ECU terminal only)
CAN(H)	SAE J1939 signal-C	Using impedance 120Ω connecting line
CAN(L)	SAE J1939 return-D	Using impedance 120Ω connecting line

Engine type: Cummins QSX15-CM570

17.5 CUMMINS GCS-MODBUS

It is suitable for GCS engine control module. Use RS485-MODBUS to read information of engine. Engine types are QSX15, QST30, QSK23/45/60/78 and so on.

Table 27 D-SUB Connector 06

Terminals of controller	D-SUB connector 06	Remark
Fuel relay output	5&8	Outside expand relay, when fuel output, making port 5 and 8 of the connector 06 connected.
Start relay output	-	Connect to starter coil directly

Table 28 D-SUB Connector 06

Terminals of controller	D-SUB connector 06	Remark
RS485 GND	20	CAN communication shielding line(connect with ECU terminal only)
RS485+	21	Using impedance 120Ω connecting line
RS485-	18	Using impedance 120Ω connecting line

Engine type: Cummins QSK-MODBUS, Cummins QST-MODBUS, Cummins QSX-MODBUS

17.6 CUMMINS QSM11
Table 29 Engine OEM Connector

Terminals of controller	OEM connector of engine	Remark
Fuel relay output	38	
Start relay output	-	Connect with starter coil directly
CAN GND	-	CAN communication shielding line(connect with controller's this terminal only)
CAN(H)	46	Using impedance 120Ω connecting line
CAN(L)	37	Using impedance 120Ω connecting line

Engine type: Common J1939

17.7 CUMMINS QSZ13
Table 30 Engine OEM Connector

Terminals of controller	OEM connector of engine	Remark
Fuel relay output	45	
Start relay output	-	Connect to starter coil directly
Programmable output 1	16&41	Idle speed control, normally open output. Making 16 connected to 41 during high-speed running via external expansion relay.
Programmable output 2	19&41	Pulse raise speed control, normally open output. Making 19 connected with 41 for 0.1s during high-speed warming via external expansion relay.
CAN GND	-	CAN communication shielding line(connect with controller's this terminal only)
CAN(H)	1	Using impedance 120Ω connecting line
CAN(L)	21	Using impedance 120Ω connecting line

Engine type: Common J1939

17.8 DETROIT DIESEL DDEC III / IV
Table 31 Engine CAN Connector

Terminals of controller	CAN port of engine	Remark
Fuel relay output	Expand 30A relay, battery voltage of ECU is supplied by relay	
Start relay output	-	Connect to starter coil directly
CAN GND	-	CAN communication shielding line(connect with controller's terminal only)
CAN(H)	CAN(H)	Using impedance 120Ω connecting line
CAN(L)	CAN(L)	Using impedance 120Ω connecting line

Engine type: Common J1939

17.9 DEUTZ EMR2
Table 32 F Connector

Terminals of controller	F connector	Remark
Fuel relay output	Expand 30A relay, battery voltage of 14 is supplied by relay. Fuse is 16A	
Start relay output	-	Connect to starter coil directly
-	1	Connect to battery negative pole
CAN GND	-	CAN communication shielding line(connect with controller's terminal only)
CAN(H)	12	Impedance 120Ω connecting line is recommended.
CAN(L)	13	Impedance 120Ω connecting line is recommended.

Engine type: VolvoEDC4

17.10 JOHN DEERE
Table 33 21-pin Connector

Terminals of controller	21 pins connector	Remark
Fuel relay output	G,J	
Start relay output	D	
CAN GND	-	CAN communication shielding line(connect with controller's terminal only)
CAN(H)	V	Using impedance 120Ω connecting line
CAN(L)	U	Using impedance 120Ω connecting line

Engine type: John Deere

17.11 MTU MDEC

Suitable for MTU engines, 2000 series, 4000series;

Table 34 X1 Pin Connector

Terminals of controller	X1 connector	Remark
Fuel relay output	BE1	
Start relay output	BE9	
CAN GND	E	CAN communication shielding line(connect with one terminal only)
CAN(H)	G	Using impedance 120Ω connecting line
CAN(L)	F	Using impedance 120Ω connecting line

Engine type: MTU-MDEC-303

17.12 MTU ADEC(SMART MODULE)

It is suitable for MTU engine with ADEC (ECU8) and SMART module.

Table 35 ADEC (X1 Port)

Terminals of controller	ADEC (X1port)	Remark
Fuel relay output	X1 10	X1 Terminal 9 Connected to negative of battery
Start relay output	X1 34	X1 Terminal 33 Connected to negative of battery

Table 36 ADEC (X4 Port)

Terminals of controller	SMART (X4 port)	Remark
CAN GND	X4 3	CAN communication shielding line(connect to controller's this terminal only)
CAN(H)	X4 1	Using impedance 120Ω connecting line
CAN(L)	X4 2	Using impedance 120Ω connecting line

Engine type: MTU-ADEC

17.13 MTU ADEC (SAM MODULE)

It is suitable for MTU engine with ADEC (ECU7) and SAM module.

Table 37 ADEC (X1 Port)

Terminals of controller	ADEC (X1port)	Remark
Fuel relay output	X1 43	X1 Terminal 28 Connected to negative of battery
Start relay output	X1 37	X1 Terminal 22 Connected to negative of battery

Table 38 SAM (X23 Port)

Terminals of controller	SAM (X23 port)	Remark
CAN GND	X23 3	CAN communication shielding line(connect with controller's this terminal only)
CAN(H)	X23 2	Using impedance 120Ω connecting line
CAN(L)	X23 1	Using impedance 120Ω connecting line

Engine type: Common J1939

17.14 PERKINS

It is suitable for ADEM3/ ADEM4 engine control module. Engine type is 2306, 2506, 1106, and 2806.

Table 39 Connector

Terminals of controller	Connector	Remark
Fuel relay output	1,10,15,33,34	
Start relay output	-	Connect to starter coil directly
CAN GND	-	CAN communication shielding line(connect with controller's terminal only)
CAN(H)	31	Using impedance 120Ω connecting line
CAN(L)	32	Using impedance 120Ω connecting line

Engine type: Perkins

17.15 SCANIA

It is suitable for S6 engine control module. Engine type is DC9, DC12, and DC16.

Table 40 B1 Connector

Terminals of controller	B1 connector	Remark
Fuel relay output	3	
Start relay output	-	Connect to starter coil directly
CAN GND	-	CAN communication shielding line(connect with controller's terminal only)
CAN(H)	9	Using impedance 120Ω connecting line
CAN(L)	10	Using impedance 120Ω connecting line

Engine type: Scania

17.16 VOLVO EDC3

Suitable engine control mode is TAD1240, TAD1241, and TAD1242.

Table 41 "Stand alone" Connector

Terminals of controller	"Stand alone" connector	Remark
Fuel relay output	H	
Start relay output	E	
programmable output 1	P	ECU power Configurable output 1,"ECU power"

Table 42 "Data Bus" Connector

Terminals of controller	"Data bus" connector	Remark
CAN GND	-	CAN communication shielding line(connect with controller's terminal only)
CAN(H)	1	Using impedance 120Ω connecting line
CAN(L)	2	Using impedance 120Ω connecting line

Engine type: Volvo

△NOTE: When this engine type is selected, preheating time should be set to at least 3 seconds.

17.17 VOLVO EDC4

Suitable engine types are TD520, TAD520 (optional), TD720, TAD720 (optional), TAD721, TAD722, and TAD732.

Table 43 Connector

Terminals of controller	Connector	Remark
Fuel relay output	Expanded 30A relay, and relay offers battery voltage for terminal14. Fuse is 16A	
Start relay output	-	Connect to starter coil directly
	1	Connected to negative of battery
CAN GND	-	CAN communication shielding line(connect with controller's terminal only)
CAN(H)	12	Using impedance 120Ω connecting line
CAN(L)	13	Using impedance 120Ω connecting line

Engine type: VolvoEDC4

17.18 VOLVO-EMS2

Volvo Engine types are TAD734, TAD940, TAD941, TAD1640, TAD1641, and TAD1642.

Table 44 Engine CAN Port

Terminals of controller	Engine's CAN port	Remark
programmable output 1	6	ECU stop Configurable output 1 "ECU stop"
Programmable output 2	5	ECU power Configurable output 2 "ECU power"
	3	Negative power
	4	Positive power
CAN GND	-	CAN communication shielding line(connect with controller's terminal only)
CAN(H)	1(Hi)	Using impedance 120Ω connecting line
CAN(L)	2(Lo)	Using impedance 120Ω connecting line

Engine type: Volvo-EMS2

▲NOTE: When this engine type is selected, preheating time should be set to at least 3 seconds.

17.19 YUCHAI

It is suitable for BOSCH common rail pump engine.

Table 45 Engine 42-pin Port

Terminals of controller	Engine 42 pins port	Remark
Fuel relay output	1.40	Connect to engine ignition lock
Start relay output	-	Connect to starter coil directly
CAN GND	-	CAN communication shielding line(connect with controller's this terminal only)
CAN(H)	1.35	Using impedance 120Ω connecting line
CAN(L)	1.34	Using impedance 120Ω connecting line

Table 36 Engine 2-pin Port

Battery	Engine 2 pins	Remark
Battery negative	1	Wire diameter 2.5mm ²
Battery positive	2	Wire diameter 2.5mm ²

Engine type: BOSCH

17.20 WEICHAH

It is suitable for Weichai BOSCH common rail pump engine.

Table 47 Engine Port

Terminals of controller	Engine port	Remark
Fuel relay output	1.40	Connect to engine ignition lock
Start relay output	1.61	
CAN GND	-	CAN communication shielding line(connect to the controller at this end only)
CAN(H)	1.35	Using impedance 120Ω connecting line
CAN(L)	1.34	Using impedance 120Ω connecting line

Engine type: GTSC1

NOTE: If there is any question of connection between controller and ECU communication, please feel free to contact SmartGen's service.

18 ETHERNET INTERFACE

18.1 ETHERNET INTERFACE INTRODUCTION

ETHERNET port is used for controller monitoring, which can realize network client connection mode.

▲NOTE: After changing controller network parameters (e.g. IP address, sub network mask etc.) new settings will take effect only after the controller is restarted.

18.2 NETWORK CLIENT MODE

When the controller is used as network client, it can be monitored via network port by using TCP ModBus protocol.

The procedure is as the following:

- 1) Set IP address and sub network mask of the controller. IP address must in the same network segment with monitoring equipment (e.g. PC), but is different from it; e.g.: if monitoring equipment IP address is 192.168.0.16, controller IP can be 192.168.0.18, sub network mask is 255.255.255.0.
- 2) Connect the controller. It can be connected to the monitoring equipment directly using network cable or via switchboard.
- 3) The communication between the controller and monitoring equipment is carried out by TCP ModBus protocol.

▲NOTE: In this connection mode controller parameters can be set. SmartGen provides testing software for this connection mode. Communication protocol can be obtained from the SmartGen service.

18.3 CONTROLLER AND NETWORK CABLE CONNECTION

Table 48 Controller Internet Access

No.	Name	Description
1	TX+	Tranceive Data+
2	TX-	Tranceive Data-
3	RX+	Receive Data+
4	NC	Not connected
5	NC	Not connected
6	RX-	Receive Data-
7	NC	Not connected
8	NC	Not connected

18.3.1 CONTROLLER CONNECT WITH PC WITH A LINE OF CABLE

For this connection crossover cable must be used.

Crossover cable: EIA/TIA 568A standard on one end and EIA/TIA 568B on the other end.

▲NOTE: If PC network port has Auto MDI/MDIX function, parallel cable can also be used.

18.3.2 CONTROLLER AND PC CONNECTION VIA SWITCHBOARD (OR ROUTER).

Parallel lines must be used.

Parallel cable: EIA/TIA 568A standard on both ends or EIA/TIA 568B standard on both ends.

▲NOTE: If switchboard (or router) network port has Auto MDI/MDIX function, crossover cable can also be used.

19 FAULT FINDING
Table 49 Fault Finding

Symptoms	Possible Solutions
Controller no response with power.	Check starting batteries; Check controller connection wirings; Check DC fuse.
Genset shutdown	Check the water/cylinder temperature is too high or not; Check the genset AC voltage; Check DC fuse.
Controller emergency stop	Check emergence stop button is correct or not; Check whether the starting battery positive is correctly connected with the emergency stop input; Check whether the circuit is open.
Low oil pressure alarm after crank disconnect	Check the oil pressure sensor and its connections.
High water temperature alarm after crank disconnect	Check the temperature sensor and its connections.
Shutdown Alarm in running	Check related switch and its connections according to the information on LCD; Check programmable inputs.
Fail to Start	Check fuel oil circuit and its connections; Check starting batteries; Check speed sensor and its connections; Refer to engine manual.
Starter no response	Check starter connections; Check starting batteries.
Genset running while ATS not transfer	Check ATS; Check the connections between ATS and controllers.
RS485 communication is abnormal	Check connections; Check setting of COM port is correct or not; Check if RS485's connections of A and B is reversely connected; Check RS485 transfer model is damaged or not; Check communication port of PC is damaged or not.
ECU communication failed	Check connections of CAN high and low polarity; Check if 120Ω resistor is correctly connected; Check if type of engine is correct; Check if connections between controller and engine and outputs setting are correct.
ECU warning or stop	Get information from LCD of alarm page; If there is detailed alarm, check engine according to description. If not, please refer to engine manual according to SPN alarm code.