

Smartgen®

APC715 Pump Unit Controller

USER MANUAL



Smart

Smartgen Technology



众智电子 Chinese trademark

Smartgen[®] English trademark

Smartgen — make your generator *smart*

Smartgen Technology Co., Ltd.

No. 28 Jinsuo Road

Zhengzhou

Henan Province

P. R. China

Tel: +86-371-67988888/67981888

+86-371-67991553/67992951

+86-371-67981000(overseas)

Fax: 0086-371-67992952

Web: <http://www.smartgen.com.cn>

<http://www.smartgen.cn>

Email: sales@smartgen.cn

All rights reserved. No part of this publication may be reproduced in any material form (including photocopying or storing in any medium by electronic means or other) without the written permission of the copyright holder.



Smartgen Technology reserves the right to change the contents of this document without prior notice.

Version

Date	Version	Note
2013-08-28	1.0	Original release.
2014-03-06	1.1	1. Add maintenance setting description. 2. Add indication alarm description. 3. Modify some speed adjustment functions. 4. Add miscellaneous screen description.

This manual is suitable for APC715 pump unit controller only.

Clarification of notation used within this publication.

SYMBOL	INSTRUCTION
 NOTE	Highlights an essential element of a procedure to ensure correctness.
 CAUTION!	Indicates a procedure or practice, which, if not strictly observed, could result in damage or destruction of equipment.
 WARNING!	Indicates a procedure or practice, which could result in injury to personnel or loss of life if not followed correctly.

CONTENTS

1	OVERVIEW.....	6
2	PERFORMANCE AND CHARACTERISTICS	7
3	SPECIFICATION.....	9
4	OPERATION.....	10
	4.1 INDICATOR LIGHT.....	10
	4.2 PUSHBUTTONS.....	11
	4.3 LCD DISPLAY.....	12
	4.3.1 MAIN DISPLAY.....	12
	4.3.2 USER MENU AND PARAMETERS SETTING MENU.....	14
	4.4 AUTO START/STOP OPERATION.....	17
	4.5 MANUAL START/STOP OPERATION	19
	4.6 ON-LOAD CONTROL PROCESS.....	20
	4.7 ADJUST SPEED CONTROL	21
5	PROTECTION	22
	5.1 WARNINGS	22
	5.2 SHUTDOWN ALARM	24
	5.3 TRIP SHUTDOWN	26
	5.4 FAULT IDLE.....	27
	5.5 INDICATION	28
6	CONNECTIONS	29
7	DEFINITION AND RANGE OF PARAMETERS.....	32
	7.1 PARAMETER CONTENTS AND RANGE (TABLE 1).....	32
	7.2 PROGRAMMABLE OUTPUT 1-5 (TABLE 2).....	42
	7.2.1 Custom Period Output.....	46
	7.2.2 Custom Combined Output.....	47
	7.3 DEFINED CONTENTS OF CONFIGURABLE INPUT PORTS (ALL ACTIVE WHEN CONNECT TO GRAND (B-)).....	48
	7.4 SELECTION OF SENSORS.....	50
	7.5 CONDITIONS OF CRANK DINSCONNECT SELECTION	51
	7.6 MAINTENANCE (FORM 6).....	52
8	PARAMETERS SETTING	53
9	SENSOR SELECT.....	54
10	TYPICAL APPLICATION.....	55
11	INSTALLATION.....	56
12	CONNECTIONS OF CONTROLLER WITH J1939 ENGINE	57

12.1 CUMMINS ISB/ISBE.....	57
12.2 CUMMINS QSL9	57
12.3 CUMMINS QSM11(IMPORT)	58
12.4 CUMMINS QSX15-CM570	58
12.5 CUMMINS GCS-MODBUS.....	59
12.6 CUMMINS QSM11	59
12.7 CUMMINS QSZ13	60
12.8 DETROIT DIESEL DDEC III / IV	60
12.9 DEUTZ EMR2.....	61
12.10 JOHN DEERE	61
12.11 MTU MDEC	61
12.12 MTU ADEC(SMART MODULE).....	62
12.13 MTU ADEC(SAM MODULE).....	62
12.14 PERKINS.....	63
12.15 SCANIA	63
12.16 VOLVO EDC3.....	64
12.17 VOLVO EDC4.....	64
12.18 VOLVO-EMS2.....	65
12.19 YUCHAI	65
12.20 WEICHAI	66
13 USB	67
14 FAULT FINDING	68

1 OVERVIEW

APC715 Pump Unit Controller is designed for pump systems which controlled by engine. It allows automatic start/stop, data measurement, alarm protection as well as remote control, remote measurement and remote communication function. Utilizing the GOV (Engine Speed Governor) control function, the controller is able to stabilize the outlet/inlet pressure via GOV. CANBUS (SAE J1939) interface enables the controller to communicate with various engine which fitted with J1939 interface.

APC715 Pump Unit Controller fit with LCD display, optional languages interface (including English, Chinese or other languages); simultaneously the exact parameters of pump unit and engine are indicated by the LCD display on the front panel and the controller is reliable and easy to use.

APC715 Pump Unit Controller adopt powerful 32-bit ARM microprocessor technology with precision parameters measuring, fixed value adjustment, time setting and set value adjusting and etc. The majority of parameters can be configured from front panel and all the parameters can be set using PC (via USB port) and can be adjusted and monitored with the help of RS485 ports. It can be widely used in a number of pump control system with compact structure, simple connections and high reliability

2 PERFORMANCE AND CHARACTERISTICS

- 480x272 pixel, 4.3 inches coloured TFT-LCD with backlight, multilingual interface (including English, Chinese or other languages) which can be chosen at the site, making commissioning convenient for factory personnel.
- Improved LCD wear-resistance and scratch resistance due to hard screen acrylic.
- Silicon panel and pushbuttons for better operation in high/low temperature environment.
- RS485 communication port enabling remote control, remote measuring, remote communication via ModBus protocol.
- Equipped with CANBUS port and can communicate with J1939 genset. Not only can you monitoring frequently-used data (such as water temperature, oil pressure, engine speed, fuel consumption and so on) of ECU machine, but also control start, stop, raising speed and speed droop via CANBUS port.
- GOV Function; outlet pressure and inlet pressure can be adjusted via GOV function. GOV port: Relay output; Analog output (for speed control unit); CANBUS port (for engine control unit).
- The controller detects not only engine speed but also gearbox speed.
- Water pressure curve and flow curve are user-defined.
- 10 analog sensors; sensors can switch between resistor type and current type using jumper.
- More kinds of curves of temperature, oil pressure, fuel level can be used directly and users can define the sensor curves by themselves.
- Precision measure and display parameters about Engine and pump unit; e.g. engine high water temperature, low oil pressure, over speed, high water pressure, low water pressure, over flow and other kinds of fault indication and protection function..
- There are two kinds of speed adjustment ways: manually and automatically; users can adjust the speed on the panel.
- Idle control function; the genset will slow down to idle running automatically when the clutch releases.
- All output ports are relay-out;
- PLC programming function; can be applied to complex system.
- Parameter setting: parameters can be modified and stored in internal FLASH

memory and cannot be lost even in case of power outage; most of them can be adjusted using front panel of the controller and all of them can be modified using PC via USB or RS485 ports.

- Multiple crank disconnect conditions (speed sensor, oil pressure) are optional;
- Widely power supply range DC(8~35)V, suitable to different starting battery voltage environment;
- Event log, real-time clock, scheduled start & stop pump unit (can be set as start pump unit once a day/week/month whether with load or not);
- Accumulative total run time A and B. Users can reset it as 0 and re-accumulative the value which make convenience to users to count the total value as their wish.
- Can control engine heater, cooler and fuel pump.
- With maintenance function. Actions can be set when maintenance time out;
- All parameters used digital adjustment, instead of conventional analog modulation with normal potentiometer, more reliability and stability;
- Waterproof security level IP55 due to rubber seal installed between the controller enclosure and panel fascia;
- Metal fixing clips enable perfect performance in high temperature environment;
- Modular design, anti-flaming ABS plastic enclosure, pluggable connection terminals and embedded installation way; compact structure with easy mounting.

3 SPECIFICATION

Items	Contents
Working Voltage	DC8. 0V to 35. 0V, Continuous Power Supply.
Overall Consumption	<4W(Standby mode: ≤2W)
Speed Sensor Voltage	1.0V to 24V (effective value)
Speed Sensor Frequency	10,000 Hz (max)
Start Relay Output	16Amp DC28V power supply
Fuel Relay Output	16Amp DC28V power supply
Programmable Relay Output 1-6	7Amp DC28V power supply
Programmable Relay Output 7-10	7Amp AC250V power supply
Analog Sensor	4 fixed sensor, 6 configurable sensor
Overall Dimensions	266 mm x 182 mm x 45 mm
Panel Cutout	214mm x 160mm
Working Condition	Temperature: (-25~70)°C; Humidity: (20~93)%RH
Storage Condition	Temperature: (-25~70)°C
Protection Level	IP55 Gasket
Weight	0.95kg

4 OPERATION

4.1 INDICATOR LIGHT



Note: Selected indicators description:



Warning indicator and Alarm indicator:

Alarm Type	Warning Indicator	Alarm Indicator
Warning	Slow flashing	Slow flashing
Shutdown Alarm	Off	Fast flashing

Running indicator: illuminated from crank successful to ETS while off during other periods.

4.2 PUSHBUTTONS







	Stop	Stop running pump unit in Auto/Manual mode; Reset alarm in stop mode; Lamp test (press at least 3 seconds); During stopping process, press this button again to stop pump unit immediately.
	Start	Start pump unit in Manual/Test mode.
	Manual Mode	Press this key and controller enters in Manual mode.
	Auto Mode	Press this key and controller enters in Auto mode.
	Mute	Alarming sound off; If there is alarm, pressing the button at least 3 seconds can reset this alarm.
	Load	Can control the clutch to switch on or off in manual mode.
	Adjust Speed	Enter/Exit the speed adjust menu.
	Up/Increase	1) Screen scroll; 2) Up cursor and increase value in setting menu.
	Down/Decrease	1) Screen scroll; 2) Down cursor and decrease value in setting menu.
	Left	1) Screen scroll; 2) Left move cursor in setting menu.
	Right	1) Screen scroll; 2) Right move cursor in setting menu.
	Set/Confirm	1. Enter into “help” interface; 2. Pressing and holding for more than 3 seconds enters parameter configuration menu; 3. In settings menu confirms the set value.
	Exit	1. Returns to the main menu; 2. In settings menu returns to the previous menu.

NOTE: In manual mode, pressing  and  simultaneously will force generator to crank. Successful start will not be judged according to crank disconnect conditions, operator will have to crank the starter motor manually; when operator decides that the engine has fired, he/she should release the button and start relay will be deactivated, safety on delay will start.

WARNING: Default password is 00318, user can change it in case of others change the advanced parameters setting. Please clearly remember the password after changing. If you forget it, please contact Smartgen services and send all information in the controller page of “**ABOUT**” to us.

4.3 LCD DISPLAY

4.3.1 MAIN DISPLAY

Main screen is divided into left and right separate viewing areas, use  to select a viewing area; the selected area is marked with  in its upper left corner. Both viewing areas show pages; use   to scroll the pages and   to scroll the screen.

★**Engine**, including as below,

Engine status, engine temperature, engine oil pressure, fuel level, Configurable Sensor 1, battery voltage, charger voltage, accumulated run time, accumulated start times.

▲**NOTE:** If connected with J1939 engine via CANBUS port, this page also includes: coolant pressure, coolant level, fuel temperature, fuel pressure, inlet temperature, exhaust temperature, turbo pressure, fuel consumption, total fuel consumption and so on. (Different engine with different parameters)

★**Pump Unit:**

Outlet pressure, pump flow, pump head, config. sensor 2~6 (can be set as temperature sensor, pressure sensor or level sensor)

Formula: Pump Head = (Outlet pressure - Static Pressure)/0.0098.

Pump flow is calculated according to relation curve of outlet pressure and flow; the relation curve should be set by users according to the actual usage.

★**Alarm:**

Display all warnings, shutdown alarms, trip shutdown alarms and the corresponding information.

▲**NOTE:** For ECU alarms and shutdown alarms, if the alarm information is displayed, check engine according to it, otherwise, please check the manual of generator according to SPN alarm code.

☐ **Event log**

Records all start/stop events (shutdown alarm, trip shutdown alarm, manual/auto start or stop) and the real time when alarm occurs.

Others, including,

Time and Date, maintenance due time, input/output ports status.

☐ **About**, including,

Issue time of software and hardware version, product PD number.

★**Miscellaneous**, including:



Working mode, engine status, engine temperature, engine oil pressure, fuel level, outlet pressure, config. sensor 2(inlet pressure), accumulated run time, real-time clock. Press  in main screen can jump to **miscellaneous screen**



★**Status**, including as below,

Engine speed, battery voltage 1, engine status

Indicator	Status
Green	Normal status; No alarm
Yellow	Warning or idle speed alarm occurs.
Red	Shutdown alarm occurs.

Example:

Engine	Pump 
On load Manual Mode Normal Running	Outlet Pressure 1.0MPa 10Bar 145psi
Engine Temp. 85°C 185°F	Config Sensor 2 45°C 113°F
Oil Pressure 465kPa 4.65Bar 67.4psi	Config Sensor 3 465kPa 4.65Bar 67.4psi
	Config Sensor 4 100%
 1500rpm	 27.6V Normal Running

Engine 	Pump
Fuel Level 100%	Config Sensor 5 55°C 131°F
Config Sensor 1 85°C 185°F	Config Sensor 6 60°C 140°F
Battery Voltage 1 27.6V	Pump Flow 200m ³ /h
Battery Voltage 2 27.6V	Pump Head 102m
 1500rpm	 27.6V Emergency Stop

4.3.2 USER MENU AND PARAMETERS SETTING MENU

Press and hold  for more than 3 seconds to enter into user menu;

★Parameter

After entering the correct password (factory default password is 00318), you can enter into parameter settings interface.

★Language

Selectable Chinese, English and others (default: Espanol)

★Commissioning

On load, off load or custom commissioning can be chosen. Custom commissioning can configure on load or not during commissioning, when to commissioning and select the mode after commissioning (manual mode, auto mode and stop mode).

★Clear users' accumulation

Can clear User Accumulated Run A, User Accumulated Run B, Engine Accumulated Run time and Accumulated Start times.

Parameter setting including as following,

★Timer settings

★Engine settings

★Analog sensor settings (Engine temperature, engine oil pressure, fuel level, config. 1~6, outlet pressure)

★Input port settings

★output port settings





★GOV settings





★Pump settings





★Module settings



★Scheduling and maintenance settings







Example,





Return	>Start Delay	Form1: Use   to scroll settings,  to enter settings (form2),  to exit settings menu.
Timers >	>Stop Delay	
Engine	>Preheat Delay	
Temp. Sensor	>Cranking Time	
OP Sensor	>Crank Rest Time	
Level Sensor	>Safety On Time	
Config Sensor 1	>Start Idle Time	
Config Sensor 2	>Warming Up Time	
Config Sensor 3	>Cooling Time	
Config Sensor 4	>Stop Idle Time	
Config Sensor 5	>ETS Hold Time	

Return	> Start Delay	Form 2: Use   to scroll settings (form 3),  to enter settings (form 4),  to return to previous menu. (form 1).
Timers >	>Stop Delay	
Engine	>Preheat Delay	
Temp. Sensor	>Cranking Time	
OP Sensor	>Crank Rest Time	
Level Sensor	>Safety On Time	
Config Sensor 1	>Start Idle Time	
Config Sensor 2	>Warming Up Time	
Config Sensor 3	>Cooling Time	
Config Sensor 4	>Stop Idle Time	
Config Sensor 5	> ETS Hold Time	

Return	>Start Delay	Form 3: Use   to scroll settings,  to enter settings (form4),  to return to previous menu. (form 1).
Timers >	>Stop Delay	
	>Preheat Delay	
Engine	> Cranking Time	
Temp. Sensor	>Crank Rest Time	
OP Sensor	>Safety On Time	
Level Sensor	>Start Idle Time	
Config Sensor 1	>Warming Up Time	
Config Sensor 2	>Cooling Time	
Config Sensor 3	>Stop Idle Time	
Config Sensor 4	>ETS Hold Time	
Config Sensor 5		

> Start Delay		Form 4: Press  to enter settings (form 5),  to return to previous menu. (form 6).
> Stop Delay	00008	
> Preheat Delay		
> Cranking Time		
>Crank Rest Time		
> Safety On Time		
> Start Idle Time		
> Warming Up Time		
> Cooling Time		
> Stop Idle Time		
> ETS Hold Time		

<ul style="list-style-type: none"> > Start Delay > Stop Delay > Preheat Delay > Cranking Time > Crank Rest Time > Safety On Time > Start Idle Time > Warming Up Time > Cooling Time > Stop Idle Time > ETS Hold Time 	<p>00008</p>	<p>Form5: Press   to change cursor position,   are used for changing cursor value,  Confirm setting (form 4),  exit setting (form 4).</p>
---	---------------------	---

<ul style="list-style-type: none"> > Start Delay > Stop Delay > Preheat Delay > Cranking Time > Crank Rest Time > Safety On Time > Start Idle Time > Warming Up Time > Cooling Time > Stop Idle Time > ETS Hold Time > Wait Stop Time 	<p>00008</p>	<p>Form 6:   are used for changing the setting contents.  Confirm setting (form 4),  to return to previous menu. (form 1).</p>
--	---------------------	--

NOTE: Pressing  can exit setting directly during setting.

4.4 AUTO START/STOP OPERATION

Auto mode is selected by pressing the  button; a LED besides the button will illuminate to confirm the operation.

Automatic Start Sequence:

1. When “Remote Start” is active, “Start Delay” timer is initiated;
2. When start delay is over, preheat relay energizes (if configured), “preheat delay XX s” information will be displayed on LCD;
3. After the above delay, the Fuel Relay is energized, and then one second later, the Start Relay is engaged. The engine is cranked for a pre-set time. If the pump unit fails to fire during this cranking attempt then the fuel relay and start relay are disengaged for the pre-set rest period; “crank rest time” begins and wait for the next crank attempt.
4. Should this start sequence continue beyond the set number of attempts, the start sequence will be terminated, the Fail to Start fault will be displayed on LCD.
5. In case of successful crank attempt, the “Safety On” timer is activated, allowing Low Oil Pressure, High Temperature, Under speed and Charge Alternator Failure inputs to stabilize without triggering the fault. As soon as this delay is over, “start idle” delay is initiated (if configured).
6. During “start idle” delay, under speed alarm is inhibited. When this delay is over, “warming up” delay is initiated (if configured).
7. After the “warming up” delay, If engine speed has reached on-load requirements, then the pump close relay will be energized; pump unit will take load; pump unit will enter into Normal Running status.

▲ **NOTE:** In case of “Remote Start (off Load)”, the procedure is the same, except for step NO. 7: the pump close relay will NOT be energised, generator will NOT accept load.



Automatic Stop Sequence,

- 1) When the “Remote Start” signal is deactivated while the “Remote Stop” signal is active, the Stop Delay is initiated.
- 2) Once this “stop delay” has expired, the Pump Unit Breaker will open and the “Cooling Delay” is then initiated. Should the Remote Start signal be re-activated during the cooling down period, the unit will return running status. Once the “Cooling Delay” expires, the “Stop Idle” delay is initiated.
- 3) During “Stop Idle” Delay (if configured), idle relay is energized.

- 4) "ETS Solenoid Hold" begins, ETS relay is energized while fuel relay is de-energized and complete stop is detected automatically
- 5) "Fail to Stop Delay" begins, complete stop is detected automatically.
- 6) Pump unit is placed into its "After stop time" after its complete stop. Otherwise, fail to stop alarm is initiated and the corresponding alarm information is displayed on LCD (If pump unit stopped successfully after "Failed to Stop" alarm, it will enter "After stop time" and remove alarm).
- 7) Pump unit is placed into its standby mode after its "After stop time".

SmartGen

4.5 MANUAL START/STOP OPERATION

- 1 Manual Start: Manual mode is selected by pressing the  button; a LED besides the button will illuminate to confirm the operation; then press  button to start the unit; can automatically detect crank successful, and unit accelerates to high-speed running automatically.

When “After Unload Idle” is enabled, the unit is idle running when crank succeed; unit accelerates to high-speed running automatically and take load after press  key by manual.

With high temperature, low oil pressure and over speed during pump unit running, controller can protect it to stop quickly (please refer to No.2~7 of Auto start operation for detail procedures).

- 2 MANUAL STOP: Press  can stop the running pump unit. (please refer to No.2~7 of Auto stop operation for detail procedures).



▲NOTE: In “manual mode”, users can control the pump unit on load or off load via “Load” key.

4.6 ON-LOAD CONTROL PROCESS

When controller is in Manual mode, manual control will be executed.

Users can control the pump unit on load or off load by pressing  key. The pump unit will unload automatically when it is stopped.

If “After Unload Idle” is selected “Disable”

Start the pump unit in manual mode and press  key during the genset is normal running, then the engine will take load; press  key again, the engine will unload and the generator is normal running.

If “After Unload Idle” is selected “Enable”:

Start the pump unit in manual mode and it enters into idle running process. The pump unit will not enter into normal running status until  key is pressed and it will take load as soon as the on-load requirements have reached.







When the pump unit is normal running with load, press  key once again will lead to the unit’s offload (i.e. load relay deactivated); then the “cooling delay” will be initiated. Once this has expired, the unit will enter into idle running status.

When controller is in Auto mode, auto control will be executed.

The pump unit will take load automatically when it is normal running and the on-load requirements have reached while unload automatically when it is stopped.

4.7 ADJUST SPEED CONTROL

Users can set the outlet pressure as the rated value simply by adjusting the engine speed. The “Adjust Speed Control” was divided into auto control and manual control.

Manual Adjust Speed: Adjust Speed mode is selected by pressing the  button; In this interface, users can adjust speed using navigational button: , manual adjust speed; , auto adjust speed; , manual raise speed; , manual drop speed. “, manual raise speed” and “, manual drop speed” buttons are active only when pump unit is normal running under “Manual Adjust Speed” mode.

Auto Adjust Speed: Under this mode, during the unit is normal running, the controller will adjust the outlet pressure/inlet pressure according to the preset to rated speed and maintain its steady automatically.

The “Auto Adjust Speed” was divided into relay adjust speed, GOV adjust speed and CAN adjust speed.

Relay Adjust Speed: Control the engine servo motor simply by using speed raise relay and speed drop relay.

GOV Adjust Speed: Control the electronic speed regulator simply by using GOV analog signal. Users should set parameters according to the actual situation as different regulators have different parameters.

CAN Adjust Speed: Control the ECU engine speed simply by using CAN interface. Parameters setting and speed adjustment method are same as GOV. SW1 should set as 5.0 and SW2 as 2.0 while adjusting.

5 PROTECTION

5.1 WARNINGS

Warnings are not shutdown alarms and do not affect the operation of the genset. Warning does not lead to shutdown, and when warning condition is no longer present, warning alarm will be cleared automatically. Warning types are as follows:

No.	Type	Description
1	Over Speed	When the controller detects that the engine speed has exceeded the pre-set value, it will initiate a warning alarm.
2	Under Speed	When the controller detects that the engine speed has fallen below the pre-set value, it will initiate a warning alarm.
3	Loss of Speed Signal	When the controller detects that the engine speed is 0 and the action select "Warn", it will initiate a warning alarm.
4	Fail To Stop	After "fail to stop" delay, if unit is not stop completely, it will initiate a warning alarm.
5	Charge Alt Fail	When the controller detects that charger voltage has fallen below the pre-set value, it will initiate a warning alarm.
6	Battery 1 Over Voltage	When the controller detects that battery 1 voltage has exceeded the pre-set value, it will initiate a warning alarm.
7	Battery 1 Under Voltage	When the controller detects that battery 1 voltage has fallen below the pre-set value, it will initiate a warning alarm.
8	Maintenance Due	When maintenance countdown time is 0 and the action select "Warn", it will initiate a warning alarm.
9	ECU Warn	If an error message is received from ECU via J1939, it will initiate a warning alarm.
10	Temperature Sensor Open Circuit	When the controller detects that the temperature sensor is open circuit and the action select "Warn", it will initiate a warning alarm.
11	High Temperature	When the controller detects that engine temperature has exceeded the pre-set value, it will initiate a warning alarm.
12	Low Temperature	When the controller detects that engine temperature has fallen below the pre-set value, it will initiate a warning alarm.
13	Oil Pressure Open Circuit	When the controller detects that the oil pressure sensor is open circuit and the action select "Warn", it will

No.	Type	Description
		initiate a warning alarm.
14	Low Oil Pressure	When the controller detects that the oil pressure has fallen below the pre-set value, it will initiate a warning alarm.
15	Level Sensor Open	When the controller detects that the level sensor is open circuit and the action select "Warn", it will initiate a warning alarm.
16	Low Fuel Level	When the controller detects that the fuel level has fallen below the pre-set value, it will initiate a warning alarm.
17	Flexible Sensor 1~6 Open	When the controller detects that the sensor is open circuit and the action select "Warn", it will initiate a warning alarm.
18	Flexible Sensor 1~6 High	When the controller detects the sensor value is higher than the max. set value, it will initiate a warning alarm.
19	Flexible Sensor 1~6 Low	When the controller detects the sensor value is lower than the min. set value, it will initiate a warning alarm.
20	Digital Input 1~9 Warn	When the action of digital input port select "Warn" and active, it will initiate a warning alarm.
21	Battery 2 Over Voltage	When the controller detects that battery 2 voltage has exceeded the pre-set value, it will initiate a warning alarm.
22	Battery 2 Under Voltage	When the controller detects that battery 2 voltage has fallen below the pre-set value, it will initiate a warning alarm.
23	Outlet Pressure Sensor Open	When the controller detects that the outlet pressure sensor is open circuit and the action select "Warn", it will initiate a warning alarm.
24	Outlet Pressure Sensor High	When the controller detects the sensor value is higher than the max. set value, it will initiate a warning alarm.
25	Outlet Pressure Sensor Low	When the controller detects the sensor value is lower than the min. set value, it will initiate a warning alarm.
26	Over Flow Warn	When the controller detects the flow value is higher than the max. set value, it will initiate a warning alarm.
27	Gearbox speed Over	When the controller detects that the gearbox speed has exceeded the pre-set value, it will initiate a warning alarm.
28	Gearbox speed Under	When the controller detects that the gearbox speed has fallen below the pre-set value, it will initiate a warning alarm.
29	End Of The Mandate	When the mandate time has expired and the action select "Warn", it will initiate a warning alarm.

5.2 SHUTDOWN ALARM

When controller detects shutdown alarm, it will send signal to open breaker and stop the unit. Shutdown alarm must be cleared manually and the fault removed to reset the module. Shutdown alarm types are as follows:

NO.	Type	Description
1	Emergency Stop	When the controller detects an emergency stop alarm signal, it will initiate a shutdown alarm.
2	Over Speed	When the controller detects that the generator speed has exceeded the pre-set value, it will initiate a shutdown alarm.
3	Under Speed	When the controller detects that the generator speed has fallen below the pre-set value, it will initiate a shutdown alarm.
4	Loss of Speed Signal	When the controller detects that the engine speed is 0 and the action select "Warn", it will initiate a shutdown alarm.
5	Maintenance Due	When maintenance countdown time is 0 and the action select "Shutdown", it will initiate a shutdown alarm.
6	ECU Shutdown	If shutdown alarm signal is received from ECU via J1939, it will initiate a shutdown alarm.
7	ECU Fail	If the module does not detect the J1939 data, it will initiate a shutdown alarm.
8	Temperature Sensor Open Circuit	When the controller detects that the temperature sensor is open circuit and the action select "Shutdown", it will initiate a shutdown alarm.
9	High Temperature	When the controller detects that engine temperature has exceeded the pre-set value, it will initiate a shutdown alarm.
10	Oil Pressure Open Circuit	When the controller detects that the oil pressure sensor is open circuit and the action select "Shutdown", it will initiate a shutdown alarm.
11	Low Oil Pressure	When the controller detects that the oil pressure has fallen below the pre-set value, it will initiate a shutdown alarm.
12	Level Sensor Open Circuit	When the controller detects that the sensor is open circuit and the action select "Shutdown", it will initiate a shutdown alarm.
13	Flexible Sensor 1~6 Open	When the controller detects that the sensor is open circuit and the action select "Shutdown", it will initiate a shutdown alarm.

NO.	Type	Description
16	Flexible Sensor 1~6 High	When the controller detects the sensor value is higher than the max. set value, it will initiate a shutdown alarm.
17	Flexible Sensor 1~6 Low	When the controller detects the sensor value is lower than the min. set value, it will initiate a shutdown alarm.
18	Digital Input 1~9 Shutdown	When the action of digital input port select "Shutdown" and active, it will initiate a shutdown alarm.
19	Outlet Pressure Sensor Open	When the controller detects that the outlet pressure sensor is open circuit and the action select "Shutdown", it will initiate a shutdown alarm.
20	Outlet Pressure Sensor High	When the controller detects the sensor value is higher than the max. set value, it will initiate a shutdown alarm.
21	Outlet Pressure Sensor Low	When the controller detects the sensor value is lower than the min. set value, it will initiate a shutdown alarm.
22	Over Flow Shutdown	When the controller detects the flow value is higher than the max. set value, it will initiate a shutdown alarm.
23	Gearbox Over speed	When the controller detects that the gearbox speed has exceeded the pre-set value, it will initiate a shutdown alarm.
24	Gearbox Under speed	When the controller detects that the gearbox speed has fallen below the pre-set value, it will initiate a shutdown alarm.
25	End Of The Mandate	When the mandate time has expired and the action select "Shutdown", it will initiate a shutdown alarm.

5.3 TRIP SHUTDOWN

On initiation of the “trip shutdown” condition the controller will de-energize the load output to remove the load from the unit. Once this has occurred, the controller will start the Cooling delay and allow the engine to cool before shutting down the engine. Trip shutdown alarm must be cleared manually and the fault removed to reset the module.

Trip shutdown alarm types are as follows:

NO.	Types	Description
1	Maintenance Due	When maintenance countdown time is 0 and the action select “Trip Shutdown”, it will initiate a trip shutdown alarm.
2	Digital Input 1~9	When the action of digital input port select “Trip Shutdown” and active, it will initiate a trip shutdown alarm.

5.4 FAULT IDLE

On initiation of the trip condition the controller will de-energize the load output to remove the load from the unit. Once this has occurred the controller will start the Cooling delay and allow the engine to cool before idle running process. Fault idle alarm must be cleared by pressing “Mute” button more than 3s manually. Fault idle alarm types are as follows:

No.	Types	Description
1	Digital Input 1~9	When the action of digital input port select “Fault idle” and active, it will initiate a trip shutdown alarm.

5.5 INDICATION

On initiation of the indication alarm the controller does not perform any action, and the alarm information will be displayed on Alarm page.

Indication alarm types are as follows:

No.	Types	Description
1	Maintenance Due	When maintenance countdown time is 0 and the action select "Indication", it will initiate a indication alarm.
2	Digital Input 1~9	When the action of digital input port select "Indication" and active, it will initiate a indication alarm.

6 CONNECTIONS

APC715 controller back panel is shown below:

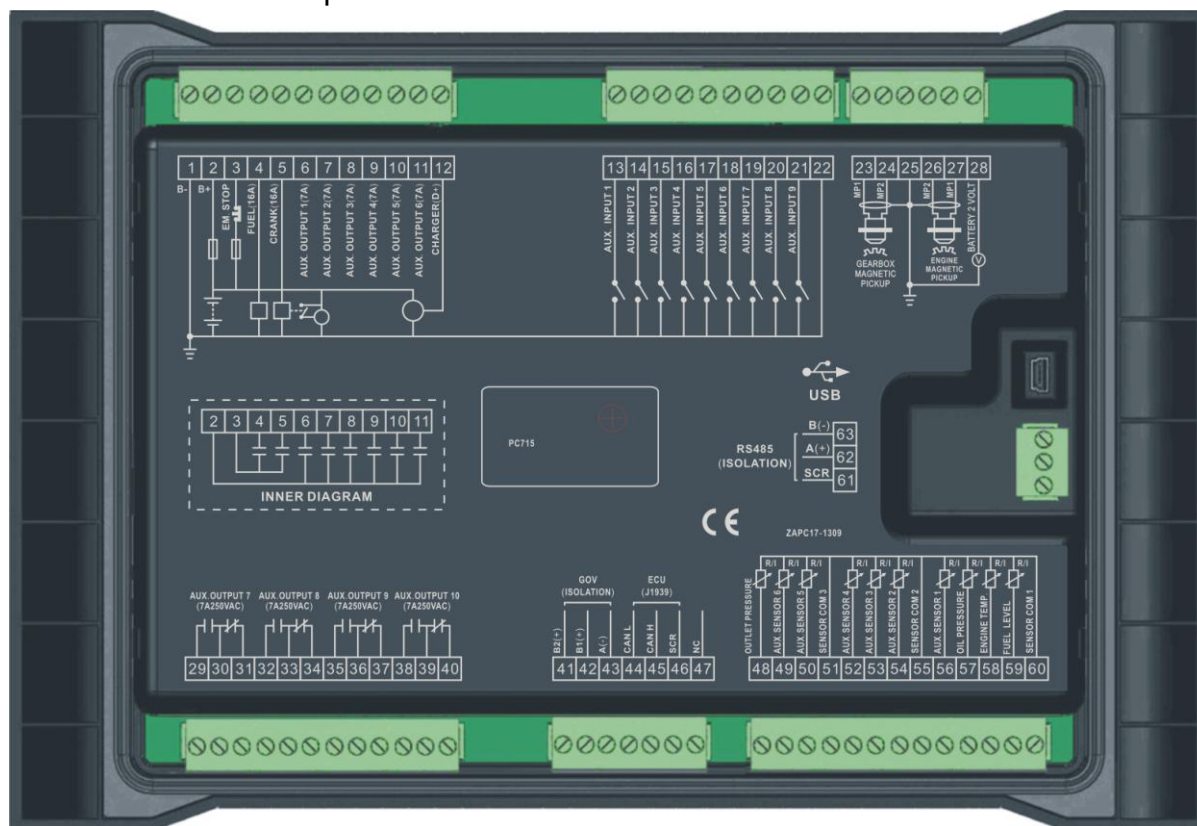

Description of terminal connections:

Pin	Function	Cable Size	Description	
1	B-	2.5mm ²	Connected with negative of starter battery.	
2	B+	2.5mm ²	Connected with positive of starter battery. If wire length is over 30m, better to double wires in parallel. Max. 20A fuse is recommended.	
3	Emergency Stop	2.5mm ²	Connected with B+ power supply via emergency stop button.	
4	Fuel Relay Output	1.5mm ²	B+ power is supplied by terminal 3, rated 16A	
5	Start Relay Output	1.5mm ²	B+ power is supplied by terminal 3, rated 16A	Connected to starter coil Details see form 2
6	Aux. Output 1	1.5mm ²	B+ power is supplied by terminal 2, rated 7A	
7	Aux. Output 2	1.5mm ²	B+ power is supplied by terminal 2, rated 7A	
8	Aux. Output 3	1.5mm ²	B+ power is supplied by terminal 2, rated 7A	
9	Aux. Output 4	1.5mm ²	B+ power is supplied by terminal 2, rated 7A	

APC715 Pump Unit Controller

Pin	Function	Cable Size	Description
10	Aux. Output 5	1.5mm ²	B+ power is supplied by terminal 2, rated 7A
11	Aux. Output 6	1.5mm ²	B+ power is supplied by terminal 2, rated 7A
12	Charger(D+)	1.0mm ²	Connected with charger starter's D+ (WL) terminals. Being hang up If there is no this terminal.
13	Aux. Input 1	1.0mm ²	Ground connected is active (B-)
14	Aux. Input 2	1.0mm ²	Ground connected is active (B-)
15	Aux. Input 3	1.0mm ²	Ground connected is active (B-)
16	Aux. Input 4	1.0mm ²	Ground connected is active (B-)
17	Aux. Input 5	1.0mm ²	Ground connected is active (B-)
18	Aux. Input 6	1.0mm ²	Ground connected is active (B-)
19	Aux. Input 7	1.0mm ²	Ground connected is active (B-)
20	Aux. Input 8	1.0mm ²	Ground connected is active (B-)
21	Aux. Input 9	1.0mm ²	Ground connected is active (B-)
22	Common GND(B-)	1.0mm ²	(B-) has already connected innerly.
23	Gearbox Magnetic Pickup 1	0.5mm ²	Connected with Gearbox Speed Sensor, shielding line is recommended. (B-) has already connected with speed sensor 2 innerly.
24	Gearbox Magnetic Pickup 2		
25	Magnetic Pickup GND		(B-) has already connected with ground innerly.
26	Engine Magnetic Pickup 2	0.5mm ²	Connected with Engine Speed Sensor, shielding line is recommended. (B-) has already connected with speed sensor 2 innerly.
27	Engine Magnetic Pickup 1		
28	Battery 2 Volt	1.0mm ²	Connected with positive of battery 2.
29	Aux. Output 7	1.5mm ²	Normally close output, rated 7A
30			Public points of relay
31			Normally open output, rated 7A
32	Aux. Output 8	1.5mm ²	Normally close output, rated 7A
33			Public points of relay
34			Normally open output, rated 7A
35	Aux. Output 9	1.5mm ²	Normally close output, rated 7A
36			Public points of relay
37			Normally open output, rated 7A
38	Aux. Output 10	1.5mm ²	Normally close output, rated 7A
39			Public points of relay
40			Normally open output, rated 7A

Details see form 3

Details see form 2

Pin	Function	Cable Size	Description
41	GOV B2+	0.5mm ²	120kΩ resistance had been connected to GOV B+ innerly.
42	GOV B1+	0.5mm ²	2-core shielding wire is recommended, its GOV end earthed.
43	GOV A-	0.5mm ²	
44	ECU CAN L	0.5mm ²	Impedance-120Ω shielding wire is recommended, its single-end earthed. 120Ω matched resistance has already connected internally.
45	ECU CAN H	0.5mm ²	
46	ECU CAN COM	/	
47	NC		Not connect.
48	Outlet Pressure Sensor	1.0mm ²	Connect to outlet pressure sensor
49	Aux. sensor 6	1.0mm ²	Spare sensor of pump unit
50	Aux. sensor 5	1.0mm ²	
51	Sensor COM 3	1.0mm ²	Public terminal of sensor, (B-) has already connected.
52	Aux. sensor 4	1.0mm ²	Spare sensor of pump unit
53	Aux. sensor 3	1.0mm ²	
54	Aux. sensor 2	1.0mm ²	
55	Sensor COM 2	1.0mm ²	Public terminal of sensor, (B-) has already connected.
56	Aux. sensor 1	1.0mm ²	Spare sensor of engine
57	Oil pressure sensor	1.0mm ²	Connected to oil pressure sensor
58	Temperature sensor	1.0mm ²	Connected to temperature sensor
59	Fuel level sensor	1.0mm ²	Connected to fuel level sensor
60	Sensor COM 1	1.0mm ²	Public terminal of sensor, (B-) has already connected.
61	RS485	/	Impedance-120Ω shielding wire is recommended, its single-end earthed.
62	RS485+	0.5mm ²	
63	RS485-	0.5mm ²	

▲NOTE: USB ports in controller rear panel are programmable parameter ports, user can directly configure controller via PC in stop mode.

7 DEFINITION AND RANGE OF PARAMETERS

7.1 PARAMETER CONTENTS AND RANGE (TABLE 1)

No.	Items	Parameter	Default	Description
Timer Setting				
1	Start Delay	(0-3600)s	1	Time from remote start signal is active to start the pump unit.
2	Stop Delay	(0-3600)s	1	Time from remote stop signal is deactivated to stop the pump unit.
3	Preheat Delay	(0-3600)s	0	Time of pre-powering heat plug before starter is powered up.
4	Cranking Time	(3-60)s	8	Time of starter power up
5	Crank Rest Time	(3-60)s	10	The waiting time before second power up when engine start fail.
6	Safety On Delay	(0-3600)s	10	Alarms for low oil pressure, high temperature, under speed, under frequency/voltage, charge fail are inactive.
7	Start Idle Time	(0-3600)s	0	Idle running time of the pump unit when starting.
8	Warming Up Time	(0-3600)s	10	Warming time between the pump unit take load and high speed running.
9	Cooling Time	(0-3600)s	10	Radiating time before stop the pump unit, after it unloads.
10	Stop Idle Time	(0-3600)s	0	Idle running time when pump unit stop.
11	ETS Solenoid Hold	(0-3600)s	20	Stop electromagnet's power on time when pump unit is stopping.
12	Fail to Stop Delay	(0-3600)s	0	Time between ending of pump unit idle delay and stopped when "ETS time" is set as 0; Time between ending of ETS hold delay and stopped when "ETS Hold output time" is not 0.
13	After Stop Time	(0-3600)s	0	Time between pump unit stopped and standby.
Engine Setting				
1	Engine Type	(0-39)	0	Default: Conventional genset (not J1939) When connected to J1939 engine,

APC715 Pump Unit Controller

No.	Items	Parameter	Default	Description
				choose the corresponding type.
2	Flywheel Teeth	(10-300)	118	Tooth number of the engine, for judging of starter separation conditions and inspecting of engine speed. See the following Installation Instruction.
3	Rated Speed	(0-6000)RPM	1500	Offer standard to judge over/under/loading speed.
4	Speed on Load	(0-1000)%	90%	Setting value is percentage of rated speed. Controller detects when it is ready to load. It won't enter into normal running process when speed is lower than loading speed.
5	Loss of Speed Signal	(0-3600)s	5	Time from detecting speed is 0 to confirm the action.
6	Loss of Speed Action	(0-1)	0	0:Warn; 1:Shutdown
7	Over Speed Shutdown	(0-1000)%	114%	Setting value is percentage of rated speed and delay value can be set.
8	Under Speed Shutdown	(0-1000)%	80%	
9	Over Speed Warn	(0-1000)%	110%	Setting value is percentage of rated speed. Delay value and return value can be set.
10	Under Speed Warn	(0-1000)%	86%	
11	Battery 1 Rated Voltage	(0-60.0)V	24.0	Standard for detecting over/under voltage of battery.
12	Battery 1 Over Volts	(0-1000)%	120%	Setting value is percentage of rated voltage of battery. Delay value & return value can be set.
13	Battery 1 Under Volts	(0-1000)%	85%	
14	Battery 2 Rated Voltage	(0-60.0)V	24.0	Standard for detecting over/under voltage of battery.
15	Battery 2 Over Volts	(0-1000)%	120%	Setting value is percentage of rated voltage of battery. Delay value & return value can be set.
16	Battery 2 Under Volts	(0-1000)%	85%	
17	Charge Alt	(0-60.0)V	8.0	In normal running, when charger

No.	Items	Parameter	Default	Description
	Fail			D+(WL) voltage under this value, charge failure alarms.
18	Start Attempts	(1-10) times	3	Max. Crank times of crank attempts. When reach this number, controller will send start failure signal.
19	Crank Disconnect	(0-2)	2	See form 5. There are 3 conditions of disconnecting starter with engine. Each condition can be used alone and simultaneously to separating the start motor and genset as soon as possible.
20	Disconnect Engine Speed	(0-1000)%	24%	Setting value is percentage of rated speed. When engine speed is higher than the set value, starter will be disconnected. See the following Installation Instruction.
21	Disconnect Oil Pressure	(0-1000)kPa	200	When generator oil pressure is higher than the set value, starter will be disconnected. See the following Installation Instruction.
22	After Unload Idle	(0-1)	0	0: Disable; 1: Enable Active when system is in manual mode. After start the unit, it is enter into idle running when the unit is not on-load.
23	Engine Idle Set	(0-100)%	60	Setting value is percentage of rated speed. Stabilize the engine speed on the set value if idle running is needed.
Module Setting				
1	Power on Mode	(0-2)	0	0: Stop mode 1: Manual mode 2: Auto mode
2	Module Address	(1-254)	1	Controller's address during remote sensing.
3	Stop Bits	(0-1)	0	0: 2 stop bits; 1: 1 stop bit
4	Language	(0-2)	0	0: Simplified Chinese 1: English 2: Others
5	Password	(0-65535)	00318	For entering advanced parameters setting.
6	Time and Date			User set
Scheduling And Maintenance Setting				
1	Scheduled	(0-1)	0	0: Disable; 1: Enable

APC715 Pump Unit Controller

No.	Items	Parameter	Default	Description
	Run			
2	Scheduled Not Run	(0-1)	0	0: Disable; 1: Enable
3	Maintenance 1	(0-1)	0	0: Disable; 1: Enable Users can set maintenance time, maintenance due action, prealarm A, prealarm B, timer mode and reset maintenance alarm. If maintenance due alarm occurs, users can reset maintenance alarm to remove it.
4	Maintenance 2	(0-1)	0	
5	Maintenance 3	(0-1)	0	
6	Maintenance 4	(0-1)	0	
7	Maintenance 5	(0-1)	0	
Analog Sensors Setting				
Temperature Sensor				
1	Curve Type	(0-15)	7	SGX. See form 5.
2	Open Circuit Action	(0-2)	0	0: Warn; 1: Shutdown; 2: No action
3	High Temp. Shutdown	(0~300)°C	98	Shutdown when external sensor temperature is higher than this value. Detecting only after safety delay is over. The delay value can be set.
4	High Temp. Warn	(0~300)°C	95	Warn when external sensor temperature is higher than this value. Detecting only after safety delay is over. The delay value and return value can be set.
5	Low Temp. Warn	(0-1)	0	0: Disable; 1: Enable
6	Custom Curve			Users should set the corresponding curve when select resistor curve type or current curve type.
Oil Pressure Sensor				
1	Curve Type	(0-15)	7	SGX. See form 5.
2	Open Circuit Action	(0-2)	0	0: Warn; 1: Shutdown; 2: No action
3	Low OP Shutdown	(0-1000)kPa	103	Shutdown when external oil pressure is lower than this value. Detecting only after safety delay is over. The delay value can be set.
4	Low OP Warn	(0-1000)kPa	124	Warn when external oil pressure is higher than this value. Detecting

No.	Items	Parameter	Default	Description
				only after safety delay is over. The delay value and return value can be set.
5	Custom Curve			Users should set the corresponding curve when select resistor curve type or current curve type.
Liquid Level Sensor				
1	Curve Type	(0-15)	4	SGH. See form 5.
2	Open Circuit Action	(0-2)	0	0:Warn; 1:Shutdown; 2:No action
3	Low Level Warn	(0-1000)%	10	Warn when external level is lower than this value. It is detecting all the time. The delay value and return value can be set.
4	Custom Curve			Users should set the corresponding curve when select resistor curve type or current curve type.
Flexible Sensor 1~6				
1	Flexible Sensor Setting	(0-1)	0	0: Disable; 1: Enable (can be set as temperature/oil pressure/liquid lever sensor)
2	Curve Type			Depends on sensor type.
3	Open Circuit Action	(0-2)	0	0:Warn; 1:Shutdown; 2:No action
4	High Shutdown	(0-9000)	100	Shutdown when external sensor value is higher than this value. The delay value and "warn enable" can be set.
5	Low Shutdown	(0-9000)	10	Shutdown when external sensor value is lower than this value. The delay value and "warn enable" can be set.
6	High Warn	(0-9000)	90	Warn when external sensor value is higher than this value. The delay value, "warn enable" and return value can be set.
7	Low Warn	(0-9000)	20	Warn when external sensor value is lower than this value. The delay value, "warn enable" and return value can be set.
8	Custom Curve			Users should set the corresponding curve when select resistor curve type or current curve type.

No.	Items	Parameter	Default	Description
Outlet Pressure Sensor				
1	Curve Type	(0-15)	2	
2	Open Circuit Action	(0-2)	1	0:Warn; 1:Shutdown; 2:No action
3	High Shutdown	(0-9000)%	120	Shutdown when external sensor value is higher than this value. The delay value and "warn enable" can be set.
4	Low Shutdown	(0-9000)%	10	Shutdown when external sensor value is lower than this value. The delay value and "warn enable" can be set.
5	High Warn	(0-9000)%	110	Warn when external sensor value is higher than this value. The delay value, "warn enable" and return value can be set.
6	Low Warn	(0-9000)%	20	Warn when external sensor value is lower than this value. The delay value, "warn enable" and return value can be set.
7	Custom Curve			Users should set the corresponding curve when select resistor curve type or current curve type.
8	Rated Outlet Pressure	(0-9000)kPa	1000	Set the outlet port's rated working pressure of pump unit.
9	Static Pressure	(0-9000)kPa	0	Set the outlet port's static pressure of pump unit.
10	Flow Function	(0-1)	0	0: Disable; 1: Enable
11	Rated Flow	(0-10000)m ³ /h	1000	Pump unit's rated working pressure.
12	Over Flow Warn	(0-1000)%	110	During normal running process, it will initiated a warning alarm signal when flow value has exceed the set value. The delay value, "warn enable" and return value can be set.
13	Over Flow Shut	(0-1000)%	120	During normal running process, it will initiate a shutdown alarm signal when flow value has exceeded the set value. The "warn enable" and delay value can be set.
14	Flow Curve			Different outlet pressures correspond to different flow value.
Flexible Input Ports				

No.	Items	Parameter	Default	Description
Flexible Input Port 1				
1	Contents Setting	(0-53)	28	Remote start (on load). See form 3.
2	Active Type	(0-1)	0	0: Closed to active 1: Open to active
Flexible Input Port 2				
1	Contents Setting	(0-53)	26	High temperature shutdown. See form 3.
2	Active Type	(0-1)	0	0: Closed to active 1: Open to active
Flexible Input Port 3				
1	Contents Setting	(0-53)	27	Low oil pressure shutdown. See form 3.
2	Active Type	(0-1)	0	0: Closed to active 1: Open to active
Flexible Input Port 4				
1	Contents Setting	(0-53)	0	User defined. See form 3.
2	Active Type	(0-1)	0	0: Closed to active 1: Open to active
3	Arming	(0-3)	2	0: From safety on 1: From starting 2: Always 3:Never
4	Active Actions	(0-4)	0	0: Warn; 1: Shutdown; 2: Trip Shutdown 3: Fault Idle 4: Indication
5	Active Delay	(0-20.0)s	2.0	Time from detecting active to confirm.
6	Description			User defined.
Flexible Input Port 5				
1	Contents Setting	(0-53)	0	User defined. See form 3.
2	Active Type	(0-1)	0	0: Closed to active 1: Open to active
3	Arming	(0-3)	2	0: From safety on 1: From starting 2: Always 3:Never
4	Active Actions	(0-4)	0	0: Warn; 1: Shutdown; 2: Trip Shutdown 3: Fault Idle 4: Indication
5	Active Delay	(0-20.0)s	2.0	Time from detecting active to confirm.
6	Description			User defined.
Flexible Input Port 6				
1	Contents Setting	(0-53)	0	User defined. See form 3.

APC715 Pump Unit Controller

No.	Items	Parameter	Default	Description
2	Active Type	(0-1)	0	0: Closed to active 1: Open to active
3	Arming	(0-3)	2	0: From safety on 1: From starting 2: Always 3:Never
4	Active Actions	(0-4)	1	0: Warn; 1: Shutdown; 2: Trip Shutdown 3: Fault Idle 4: Indication
5	Active Delay	(0-20.0)s	2.0	Time from detecting active to confirm.
6	Description			User defined.
Flexible Input Port 7				
1	Contents Setting	(0-53)	5	Lamp Test. See form 3.
2	Active Type	(0-1)	0	0: Closed to active 1: Open to active
Flexible Input Port 8~9				
1	Contents Setting	(0-53)	0	User defined. See form 3.
2	Active Type	(0-1)	0	0: Closed to active 1: Open to active
3	Arming	(0-3)	0	0: From safety on 1: From starting 2: Always 3:Never
4	Active Actions	(0-4)	0	0: Warn; 1: Shutdown; 2: Trip Shutdown 3: Fault Idle 4: Indication
5	Active Delay	(0-20.0)s	2.0	Time from detecting active to confirm.
6	Description			User defined.
Flexible Output Ports				
Flexible Output Port 1				
1	Contents Setting	(0-239)	1	User defined period output (default output is in preheating) See form 4.
2	Active Type	(0-1)	0	0:Normally open; 1:Normally close
Flexible Output Port 2				
1	Contents Setting	(0-239)	35	Idle speed control. See form 4.
2	Active Type	(0-1)	0	0:Normally open; 1:Normally close
Flexible Output Port 3				
1	Contents Setting	(0-239)	29	On-load control. See form 4.
2	Active Type	(0-1)	0	0:Normally open; 1:Normally close
Flexible Output Port 4				
1	Contents	(0-239)	31	Reserved. See form 4.

No.	Items	Parameter	Default	Description
	Setting			
2	Active Type	(0-1)	0	0:Normally open; 1:Normally close
Flexible Output Port 5				
1	Contents Setting	(0-239)	38	ETS solenoid hold. See form 4.
2	Active Type	(0-1)	0	0:Normally open; 1:Normally close
Flexible Output Port 6				
1	Contents Setting	(0-239)	48	Common alarm. See form 4.
2	Active Type	(0-1)	0	0:Normally open; 1:Normally close
Flexible Output Port 7~10				
1	Contents Setting	(0-239)	0	Not used. See form 4.
2	Active Type	(0-1)	0	0:Normally open; 1:Normally close
GOV Setting				
1	Adjust Speed Type	(0-2)	2	0: Not Used; 1: Relay Adjust Speed; 2: GOV Adjust Speed
2	GOV Output Reverse	(0-1)	0	0: Disable; 1: Enable.
3	GOV Center Voltage SW1	(0-10.0)	0	Default central voltage: 0V
4	GOV Voltage Range SW2	(0-10.0)	2.0	Default volt. range: (-2.5~+2.5)V
5	GOV Gain	(0-100)	20	GOV gain control
6	GOV Stability	(0-100)	20	GOV stability control
7	Relay Adjust Speed Dead Band	(0-10.0)%	1.0	GOV relay control
8	GOV Relay Gain	(0-100)%	10	
9	GOV Relay Stability	(0.05-1.60)s	0.10	
10	GOV Relay Response	(0.25-4.00)	0.5	
11	Adjust Speed Object	(0-1)	0	0: Outlet Pressure, 1: Inlet Pressure Configurable sensor 2 is regarded as inlet pressure sensor if the object is set as "Inlet Pressure".
12	Inlet Pressure Stability	(0-2000)kPa	10	Stabilize the inlet pressure on the set value if the object is set as "Inlet Pressure".

No.	Items	Parameter	Default	Description
Pump Unit Setting				
1	Speed Enabled	(0-1)	0	0: Disable; 1: Enable.
2	Flywheel Teeth	(1-300)	118	Tooth number of the engine.
3	Rated Speed	(0-6000)RPM	500	Offer standard to judge over/under speed.
4	Over Speed Shut	(0-1000)%	114%	Setting value is percentage of rated speed and delay value can be set.
5	Under Speed Shut	(0-1000)%	80%	
6	Over Speed Warn	(0-1000)%	110%	Setting value is percentage of rated speed. Delay value and return value can be set.
7	Under Speed Warn	(0-1000)%	86%	

7.2 PROGRAMMABLE OUTPUT 1-5 (TABLE 2)

No.	Type	Description
0	Not Used	
1	Custom Period 1	Details of function description please see the following.
2	Custom Period 2	
3	Custom Period 3	
4	Custom Period 4	
5	Custom Period 5	
6	Custom Period 6	
7	Custom Combined 1	
8	Custom Combined 2	
9	Custom Combined 3	
10	Custom Combined 4	
11	Custom Combined 5	
12	Custom Combined 6	
13	Reserved	
14	Reserved	
15	Reserved	
16	Start Relay B	If "Start Relay B" is configured, start relay and start relay B will output alternately in multi-startup process; Are used to control double power supply ATS.
17	Air Flap	Action when over speed shutdown and emergence stop. It can close the air inflow to stop the engine as soon as possible.
18	Audible Alarm	Action when warning or shutdown occurs. Can be connected annunciator externally. When "alarm mute" input port is active, the alarm will be prohibit.
19	Louver Control	Action in genset starting and disconnect when genset stopped completely.
20	Fuel Pump Control	It is controlled by fuel pump of level sensor's limited threshold.
21	Heater Control	It is controlled by heating of temperature sensor's limited threshold.
22	Cooler Control	It is controlled by cooler of temperature sensor's limited threshold.
23	Oil Pre-supply	Actions in period of cranking to safety run.
24	Reserved	
25	Pre-Lubricate	Actions in period of pre-heating to safety

		run.
26	Remote PC Output	This port is controlled by RS485 communication (PC).
27	Reserved	
28	Reserved	
29	On-load Output	Control generator to take load or off load.
30	Reserved	
31	Reserved	
32	Reserved	
33	Crank Relay	Action when genset is starting and disconnect when crank successful.
34	Fuel Relay	Action when genset is starting and disconnect when stop is completed.
35	Idle Control	Used for engine which has idles. Close before starting and open in warming up delay; Close during stopping idle process and open when stop is completed.
36	Raise Speed	Action in warming up delay and be controlled by GOV in normal running process.
37	Drop Speed	Action between the period from "stop idle" to "failed to stop" and be controlled by GOV in normal running process.
38	ETS Control	Used for engines with ETS electromagnet. Close when stop idle is over and open when pre-set "ETS delay" is over.
39	Pulse Drop speed	Active 0.1s when controller enter into stop idle, used for control part of ECU dropping to idle speed (temporary reserved).
40	ECU Stop	Suitable for engines which fitted with ECU; used for control ECU stop.
41	ECU Power Supply	Suitable for engines which fitted with ECU; used for control ECU power supply.
42	Pulse raise speed	Active 0.1s when controller enter into warming up delay; used for control part of ECU raising to normal speed (temporary reserved).
43	Crank Success	Close when detects a successful start signal.

APC715 Pump Unit Controller

44	Reserved	
45	Reserved	
46	Reserved	
47	Start Battery Cycle	During cranking process, start battery will be switchover circularly if multiple crank is needed.
48	Common Alarm	Action when pump unit common warning, common shutdown alarm.
49	Common Trip	Action when common trip alarm.
50	Common Shutdown	Action when common shutdown alarm.
51	Common Fault Idle Alarm	Action when fault idle alarm.
52	Common Warn Alarm	Action when common warning alarm.
53	Reserved	
54	Battery 1 High Volts	Action when battery 1 over voltage warning alarm.
55	Battery 1 Low Volts	Action when battery 1 low voltage warning alarm.
56	Charge Alt Fail	Action when charge failure warning alarms.
57	Reserved	
58	Reserved	
59	Reserved	
60	ECU Warn	Indicate ECU sends a warning signal.
61	ECU Shutdown	Indicate ECU sends a shutdown signal.
62	ECU COM Fail	Indicate controller cannot communicate with ECU.
63	Reserved	
64	Reserved	
65	Reserved	
66	Reserved	
67	Reserved	
68	Reserved	
69	Aux Input 1 Active	Action when input port 1 is active.
70	Aux Input 2 Active	Action when input port 2 is active.
71	Aux Input 3 Active	Action when input port 3 is active.
72	Aux Input 4 Active	Action when input port 4 is active.
73	Aux Input 5 Active	Action when input port 5 is active.
74	Aux Input 6 Active	Action when input port 6 is active.
75	Aux Input 7 Active	Action when input port 7 is active.
76	Aux Input 8 Active	Action when input port 8 is active.
77	Aux Input 9 Active	Action when input port 9 is active.
78~96	Reserved	
97	Battery 2 High Volts	Action when battery 2 over voltage

APC715 Pump Unit Controller

		warning alarm.
98	Battery 2 Low Volts	Action when battery 2 low voltage warning alarm.
99	Emergency Stop	Action when emergency stop alarm.
100	Failed To Start	Action when failed start alarm.
101	Failed To Stop	Action when failed stop alarm.
102	Under Speed Warn	Action when under speed alarm.
103	Under Speed Shutdown	Action when under speed shuts down.
104	Over Speed Warn	Action when over speed warning.
105	Over Speed Shutdown	Action when over speed shutdown alarm.
106~138	Reserved	
139	High Temp Warn	Action when high temperature warning.
140	Low Temp Warn	Action when low temperature warning.
141	High Temp Shutdown	Action when hi-temperature Shutdown alarm.
142	Reserved	
143	Low OP Warn	Action when low oil pressure warning.
144	Low OP Shutdown	Action when low oil pressure shutdown.
145	OP Sensor Open	Action when oil pressure sensor is open circuit.
146	Reserved	
147	Low Level Warn	Action when low oil level warning.
148	Over Flow Shutdown	Action when low oil pressure shutdown.
149	Over Flow Warn	Action when low oil pressure warning.
150	Config 1 High Warn	
151	Config 1 Low Warn	
152	Config 1 High Shut	
153	Config 1 Low Shut	
154	Config 2 High Warn	
155	Config 2 Low Warn	
156	Config 2 High Shut	
157	Config 2 Low Shut	
158	Config 3 High Warn	
159	Config 3 Low Warn	
160	Config 3 High Shut	
161	Config 3 Low Shut	
162	Config 4 High Warn	
163	Config 4 Low Warn	
164	Config 4 High Shut	
165	Config 4 Low Shut	
166	Config 5 High Warn	
167	Config 5 Low Warn	

168	Config 5 High Shut	
169	Config 5 Low Shut	
170	Config 6 High Warn	
171	Config 6 Low Warn	
172	Config 6 High Shut	
173	Config 6 Low Shut	
174	Outlet High Warn	
175	Outlet Low Warn	
176	Outlet High Shut	
177	Outlet Low Shut	
178~229	Reserved	
230	Stop Mode	Action in stop mode.
231	Manual Mode	Action in Manual mode.
232	Reserved	
233	Auto Mode	Action in Auto mode.
234	Loading Status	Indicate the system is on-load.
235~239	Reserved	

7.2.1 Custom Period Output

Defined Period output is composed by 2 parts, period output S1 and condition output S2.



While S1 and S2 are **TRUE** synchronously, **OUTPUT**;

While S1 or S2 is **FALSE**, **NOT OUTPUT**.

Period output S1, can set pump unit's one or more period output freely, can set the delayed time and output time after enter into period.

Condition output S2; can set as any conditions in output ports.

▲NOTE: when delay time and output time both are 0 in period output S1, it is **TRUE** in this period.

Example,

Output period: start

Delay output time: 2s

Output time: 3s

Condition output contents: output port 1 is active

Close when condition output active/inactive: close when active (disconnect when inactive);

Output port 1 active, after enter "starts time" and delay 2s, this defined period output is outputting, after 3s, stop outputting;

Output port 1 inactive, defined output period is not outputting.

7.2.2 Custom Combined Output

Defined combination output is composed by 3 parts, condition output S1 or S2 and condition output S3.

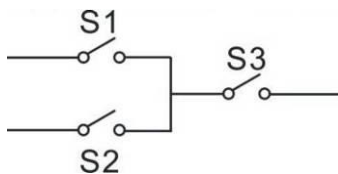

S1 or S2 is **TRUE**, while S3 is **TRUE**, Defined combination output is outputting;

S1 and S2 are **FALSE**, or S3 is **FALSE**, Defined combination output is not outputting.

▲**NOTE:** S1, S2, S3 can be set as any contents except for “defined combination output” in the output setting.

▲**NOTE:** 3 parts of defined combination output (S1, S2, S3) couldn't include or recursively include themselves.

Example,

Contents of probably condition output S1: output port 1 is active;

Close when probably condition output S1 is active /inactive: close when active (disconnect when inactive);

Contents of probably condition output S2, output port 2 is active;

Close when probably condition output S2 is active /inactive: close when active (disconnect when inactive);



Contents of probably condition output S3: output port 3 is active;

Close when probably condition output S3 is active /inactive: close when active (disconnect when inactive);

When input port 1 active or input port 2 active, if input port 3 is active, Defined combination output is outputting; If input port 3 inactive, Defined combination output is not outputting;

When input port 1 inactive and input port 2 inactive, whatever input port 3 is active or not, Defined combination output is not outputting.

7.3 DEFINED CONTENTS OF CONFIGURABLE INPUT PORTS (ALL ACTIVE WHEN CONNECT TO GRAND (B-))

No.	Type	Description
0	Users Configured	Including following functions, Indication: indicate only, not warning or shutdown. Warning: warn only, not shutdown. Shutdown: alarm and shutdown immediately Never: input inactive. Always: input is active all the time. From crank: detecting as soon as start. From safety on: detecting after safety on run delay.
1	Reserved	
2	Alarm Mute	Can prohibit "Audible Alarm" output when input is active.
3	Reset Alarm	Can reset shutdown alarm when input is active.
4	Reserved	
5	Lamp Test	All LED indicators are illuminating when input is active.
6	Panel Lock	All buttons in panel is inactive except  and there is  in the left of first row in LCD when input is active.
7	Crank Success	Means that the engine is start successfully when the input is active. Crank success condition judge are disabled if the "Crank Success" is configured.
8	Idle Control Mode	Under speed protection is inactive.
9	Inhibit Auto Stop	In Auto mode, during pump unit normal running, when input is active, inhibit pump unit shutdown automatically.
10	Inhibit Auto Start	In Auto mode, inhibit pump unit start automatically when input is active.
11	Inhibit Scheduled	In Auto mode, inhibit pump unit scheduled run when input is active.
12	Reserved	
13	Loading Status	Connect to Aux. Points of clutch.
14	Load Inhibit	Prohibit pump unit onload when input is active.
15	Reserved	
16	Reserved	
17	Reserved	
18	Reserved	
19	Reserved	
20	Reserved	
21	Inhibit Alarm Stop	All shutdown alarms are prohibited except

APC715 Pump Unit Controller

		emergence stop.(Means battle mode)
22	Aux Instrument Mode	All outputs are prohibited in this mode.
23	Reserved	
24	Reset Maintenance	Controller will reset maintenance 1 time and date as default when input is active.
25	Reserved	
26	Aux. High Temp	Connect to sensor digital input.
27	Aux. Low OP	Connect to sensor digital input.
28	Remote Start (On Load)	In Auto mode, when the input is active, pump unit can be started automatically and take load after pump unit normal running.
29	Remote Start (Off Load)	In Auto mode, when the input is active, pump unit can be started automatically and NOT take load after pump unit normal running.
30	Aux. Manual Start	In Manual mode, when the input is active, pump unit will start automatically; when input inactive, pump unit will stop automatically.
31	Reserved	
32	Remote Stop	In Auto mode, when the input is active as well as remote start signal is inactive, pump unit can be stopped automatically.
33	Simulate Stop key	An external button (not self-locking) can be connected and pressed as simulate panel.
34	Simulate Manual key	
35	Reserved	
36	Simulate Auto key	An external button (not self-locking) can be connected and pressed as simulate panel.
37	Simulate Start key	
38	Simulate Load key	
39~51	Reserved	
52	Speed Raise Input	An external button (not self-locking) can be connected and control GOV manually.
53	Speed Drop Input	

7.4 SELECTION OF SENSORS

No.		Description	Remark
1	Temperature Sensor	0 Not used 1 Custom Res Curve 2 Custom 4-20mA curve 3 VDO 4 CURTIS 5 VOLVO-EC 6 DATCON 7 SGX 8 SGD 9 SGH 10 PT100 11~15 Reserved	Defined resistance's range is (0~6)K Ω , default is SGX sensor.
2	Pressure Sensor	0 Not used 1 Custom Res Curve 2 Custom 4-20mA curve 3 VDO 10Bar 4 CURTIS 5 VOLVO-EC 6 DATCON 10Bar 7 SGX 8 SGD 9 SGH 10~15 Reserved	Defined resistance's range is (0~6)K Ω , default is SGX sensor.
3	Fuel Level Sensor	0 Not used 1 Custom Res Curve 2 Custom 4-20mA curve 3 SGD 4 SGH 5~15 Reserved	Defined resistance's range is (0~6)K Ω , default is SGH sensor.

▲ Note: User should take the controller apart to change the jumper hat from resistor side to current side if your pump unit fitted with 4~20mA sensor.

7.5 CONDITIONS OF CRANK DINSCONNECT SELECTION

No.	Setting description
0	Engine Speed
1	Oil pressure
2	Oil pressure + Engine Speed

▲NOTE:

1. There are 3 conditions to make starter disconnected with engine. Engine speed and oil pressure both can be used separately. We recommend that oil pressure should be using with engine speed together, in order to make the starter motor is separated with engine immediately and can check crank disconnect exactly.
2. Engine speed is the magnetic equipment which be installed in starter for detecting flywheel teeth.
3. When set as engine speed, must ensure that the number of flywheel teeth is as same as setting, otherwise, “over speed shutdown” or “under speed shutdown” may be caused.
4. If pump unit without engine speed sensor, please don't select corresponding items, otherwise, “start fail” or “loss speed signal” maybe caused.
5. If genset without oil pressure sensor, please don't select corresponding items.

7.6 MAINTENANCE (FORM 6)

Items	Content	Description
Enable Select	0: Disable; 1: Enable	Used for setting the current maintenance function.
Maintenance Interval	(0-30000)h	The time interval between two maintenance.
Maintenance Due	0: No Action; 1: Warn; 2: Shutdown; 3: Indication.	They are the alarm action types when the maintenance time is due.
Prealarm A	(0-30000)h	Maintenance remaining time
Prealarm A Action	0: No Action; 1: Warn; 2: Shutdown; 3: Indication.	They are the alarm action types when the maintenance remaining time is left prealarm A time only.
Prealarm B	(0-30000)h	Maintenance remaining time
Prealarm B Action	0: No Action; 1: Warn; 2: Shutdown; 3: Indication.	They are the alarm action types when the maintenance remaining time is left prealarm B time only.
Timer Mode	0: Running Time; 1: Real Time Clock	The maintenance timer mode
Reset Maintenance Alarm		Reset maintenance alarm when the maintenance time is due.
Description		The maintenance name are user-set. E.g. Change oil

8 PARAMETERS SETTING

1. Please change the controller parameters when generator is in standby mode only (e. g. Crank disconnect conditions selection, digital input, digital output, various delay), otherwise, shutdown and other abnormal conditions may occurs.
2. Maximum set value must over minimum set value in case that the condition of too high as well as too low will happen.
3. When setting the warning alarm, please set the correct return value; otherwise, maybe there is abnormal alarm. When setting the maximum value, the return value must less than set value; When setting the minimum value, the return value must over than set value.
4. Digital input could not be set as same items; otherwise, there are abnormal functions. However, the digital output can be set as same items.

9 SENSOR SELECT

- 1) When reselect sensors, the sensor curve will be transferred into the standard value. For example, if temperature sensor is SGX (120°C resistor type), its sensor curve is SGX (120°C resistor type); if select the SGD (120° C resistor type), the temperature sensor curve is SGD curve.
- 2) When there is difference between standard sensor curves and using sensor, user can adjust it in “curve type” .
- 3) When input the sensor curve, X value (resistor) must be input from small to large, otherwise, mistake occurs.
- 4) If select sensor type as “None” , sensor curve is not working and LCD does not display the sensor information.
- 5) If there is alarm switch only for the select sensor, user must set the sensor as “None” , otherwise, maybe shutdown or warning occurs.
- 6) The headmost or backmost values in the vertical coordinates can be set as same as below,

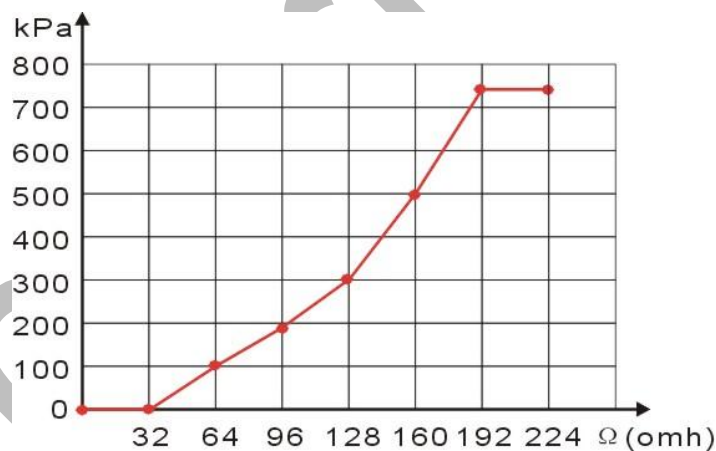

Common unit conversion table

	N/m ² (pa)	kgf/cm ²	bar	(p/in ² .psi)
1Pa	1	1.02x10 ⁻⁵	1x10 ⁻⁵	1.45x10 ⁻⁴
1kgf/cm ²	9.8x10 ⁴	1	0.98	14.2
1bar	1x10 ⁵	1.02	1	14.5
1psi	6.89x10 ³	7.03x10 ⁻²	6.89x10 ⁻²	1

10 TYPICAL APPLICATION

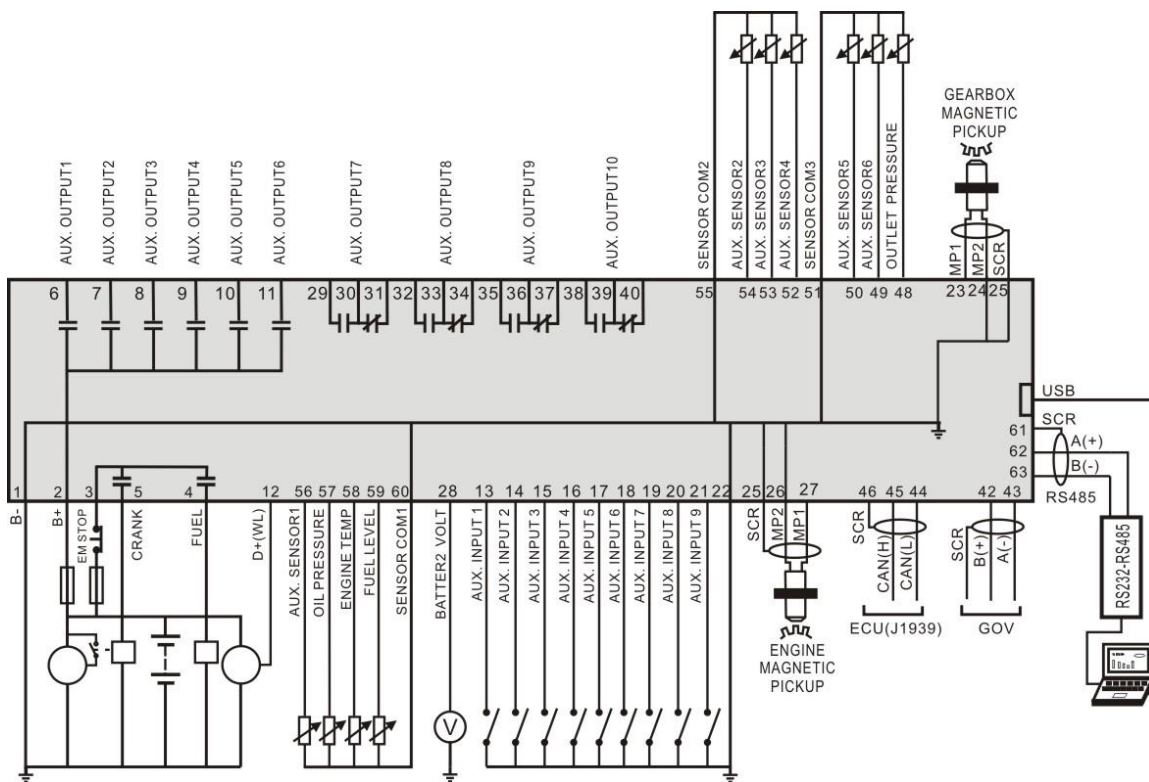

11 INSTALLATION

Controller is panel built-in design; it is fixed by clips when installed.

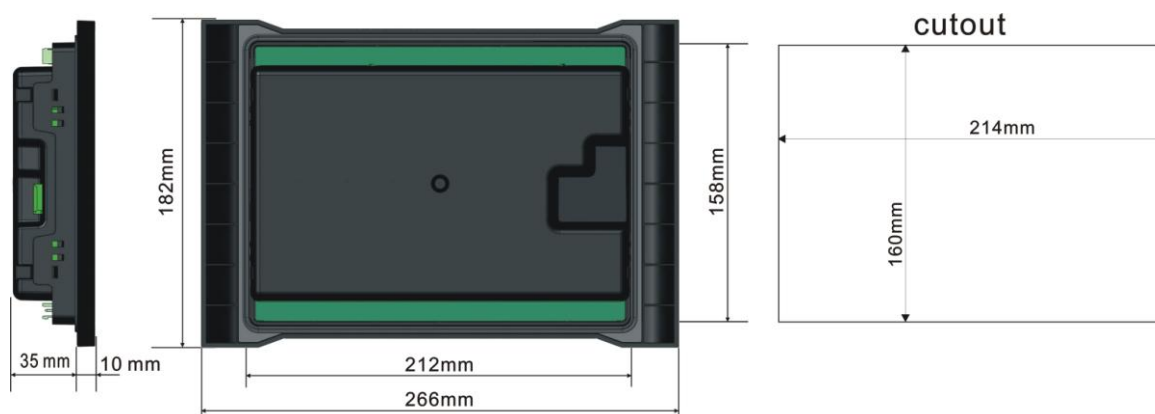

1) Battery Voltage Input

▲NOTE: APC715 controller can suit for widely range of battery voltage DC(8~35)V. Negative of battery must be connected with the engine shell soundly. The diameter of wire which from power supply to battery must be over 2.5mm^2 . If floating charge configured, please firstly connect output wires of charger to battery's positive and negative directly, then, connect wires from battery's positive and negative to controller's corresponding input ports in order to prevent charge disturbing the controller's normal working.

2) Speed Sensor Input

▲NOTE: Speed sensor is the magnetic equipment which be installed in starter and for detecting flywheel teeth. Its connection wires to controller should apply for 2 cores shielding line. The shielding layer should connect to shielding GND terminal in controller while another side is hanging in air. The else two signal wires are connected to MP1 and MP2 terminals, moreover, MP2 has already connected to B- innerly. The output voltage of speed sensor should be within AC(1~24)V (effective value) during the full speed. AC12V is recommended (in rated speed). When install the speed sensor, let the sensor is spun to contacting flywheel first, then, port out 1/3 lap, and lock the nuts of sensor at last.

3) Output And Expansion Relay

▲NOTE: All outputs of controller are relay contact output type. If need to expand the relays, please add freewheel diode to both ends of expand relay's coils (when coils of relay has DC current) or, add resistance-capacitance return circuit (when coils of relay has AC current), in order to prevent disturbance to controller or others equipment.

12 CONNECTIONS OF CONTROLLER WITH J1939 ENGINE

12.1 CUMMINS ISB/ISBE

Terminals of controller	Connector B	Remark
Fuel relay output	39	
Start relay output	-	Connect with starter coil directly
Auxiliary output port 1	Expand 30A relay, battery voltage of 01,07,12,13 is supplied by relay	ECU power Set Auxiliary output 1 as "ECU power"

Terminals of controller	9 pins connector	Remark
CAN GND	SAE J1939 shield	CAN communication shielding line(connect with ECU terminal only)
CAN(H)	SAE J1939 signal	Impedance 120Ω connecting line is recommended.
CAN(L)	SAE J1939 return	Impedance 120Ω connecting line is recommended.

Engine type: Cummins ISB

12.2 CUMMINS QSL9

Suitable for CM850 engine control mode

Terminals of controller	50 pins connector	Remark
Fuel relay output	39	
Start relay output	-	Connect to starter coil directly

Terminals of controller	9 pins connector	Remark
CAN GND	SAE J1939 shield-E	CAN communication shielding line(connect with ECU terminal only)
CAN(H)	SAE J1939 signal-C	Impedance 120Ω connecting line is recommended.
CAN(L)	SAE J1939 return-D	Impedance 120Ω connecting line is recommended.

Engine type: Cummins-CM850

12.3 CUMMINS QSM11(IMPORT)

It is suitable for CM570 engine control module. Engine type is QSM11 G1, QSM11 G2.

Terminals of controller	C1 connector	Remark
Fuel relay output	5&8	Outside expand relay, when fuel output, making port 5 and port 8 of C1 be connected
Start relay output	-	Connect to starter coil directly

Terminals of controller	3 pins data link connector	Remark
CAN GND	C	CAN communication shielding line(connect with ECU terminal only)
CAN(H)	A	Impedance 120Ω connecting line is recommended.
CAN(L)	B	Impedance 120Ω connecting line is recommended.

Engine type: Cummins ISB

12.4 CUMMINS QSX15-CM570

It is suitable for CM570 engine control module. Engine type is QSX15.

Terminals of controller	50 pins connector	Remark
Fuel relay output	38	Oil spout switch
Start relay output	-	Connect to starter coil directly

Terminals of controller	9 pins connector	Remark
CAN GND	SAE J1939 shield-E	CAN communication shielding line(connect with ECU terminal only)
CAN(H)	SAE J1939 signal-C	Impedance 120Ω connecting line is recommended.
CAN(L)	SAE J1939 return-D	Impedance 120Ω connecting line is recommended.

Engine type: Cummins QSX15-CM570

12.5 CUMMINS GCS-MODBUS

It is suitable for GCS engine control module. Use RS485-MODBUS to read information of engine. Engine types are QSX15, QST30, QSK23 / 45/60/78 and so on.

Terminals of controller	D-SUB connector 06	Remark
Fuel relay output	5&8	Outside expand relay, when fuel output, making port 05 and 08 of the connector 06 be connected.
Start relay output	-	Connect to starter coil directly

Terminals of controller	D-SUB connector 06	Remark
RS485 GND	20	CAN communication shielding line(connect with ECU terminal only)
RS485+	21	Impedance 120Ω connecting line is recommended.
RS485-	18	Impedance 120Ω connecting line is recommended.

Engine type: Cummins QSK-MODBUS, Cummins QST-MODBUS, Cummins QSX-MODBUS

12.6 CUMMINS QSM11

Terminals of controller	OEM connector of engine	Remark
Fuel relay output	38	
Start relay output	-	Connect with starter coil directly
CAN GND	-	CAN communication shielding line(connect with controller's this terminal only)
CAN(H)	46	Impedance 120Ω connecting line is recommended.
CAN(L)	37	Impedance 120Ω connecting line is recommended.

Engine type: common J1939

12.7 CUMMINS QSZ13

Terminals of controller	OEM connector of engine	Remark
Fuel relay output	45	
Start relay output	-	Connect to starter coil directly
Programmable output 1	16&41	Setting to idle speed control, normally open output. Making 16 connect to 41 during high-speed running of controller via external expansion relay.
Programmable output 2	19&41	Setting to pulse raise speed control, normally open output. Making 19 connect with 41 for 0.1s during high-speed warming of controller via external expansion relay.
CAN GND	-	CAN communication shielding line(connect with controller's this terminal only)
CAN(H)	1	Impedance 120Ω connecting line is recommended.
CAN(L)	21	Impedance 120Ω connecting line is recommended.

Engine type: QSZ13, speed regulation can be implemented.

12.8 DETROIT DIESEL DDEC III / IV

Terminals of controller	CAN port of engine	Remark
Fuel relay output	Expand 30A relay, battery voltage of ECU is supplied by relay	
Start relay output	-	Connect to starter coil directly
CAN GND	-	CAN communication shielding line (connect with controller's terminal only)
CAN(H)	CAN(H)	Impedance 120Ω connecting line is recommended.
CAN(L)	CAN(L)	Impedance 120Ω connecting line is recommended.

Engine type: Common J1939

12.9 DEUTZ EMR2

Terminals of controller	F connector	Remark
Fuel relay output	Expand 30A relay, battery voltage of 14 is supplied by relay. Fuse is 16A.	
Start relay output	-	Connect to starter coil directly
-	1	Connect to battery negative pole
CAN GND	-	CAN communication shielding line(connect with controller's terminal only)
CAN(H)	12	Impedance 120Ω connecting line is recommended.
CAN(L)	13	Impedance 120Ω connecting line is recommended.

Engine type: VolvoEDC4**12.10 JOHN DEERE**

Terminals of controller	21 pins connector	Remark
Fuel relay output	G,J	
Start relay output	D	
CAN GND	-	CAN communication shielding line(connect with controller's terminal only)
CAN(H)	V	Impedance 120Ω connecting line is recommended.
CAN(L)	U	Impedance 120Ω connecting line is recommended.

Engine type: John Deere**12.11 MTU MDEC**

Suitable for MTU engines, 2000 series, 4000series

Terminals of controller	X1 connector	Remark
Fuel relay output	BE1	
Start relay output	BE9	
CAN GND	E	CAN communication shielding line(connect with one terminal only)
CAN(H)	G	Impedance 120Ω connecting line is recommended.
CAN(L)	F	Impedance 120Ω connecting line is recommended.

Engine type: MTU-MDEC-303

12.12 MTU ADEC(SMART MODULE)

It is suitable for MTU engine with ADEC (ECU8) and SMART module.

Terminals of controller	ADEC (X1port)	Remark
Fuel relay output	X1 10	X1 Terminal 9 Connected to negative of battery
Start relay output	X1 34	X1 Terminal 33 Connected to negative of battery

Terminals of controller	SMART (X4 port)	Remark
CAN GND	X4 3	CAN communication shielding line(connect to controller's this terminal only)
CAN(H)	X4 1	Impedance 120Ω connecting line is recommended.
CAN(L)	X4 2	Impedance 120Ω connecting line is recommended.

Engine type: MTU-ADEC

12.13 MTU ADEC(SAM MODULE)

It is suitable for MTU engine with ADEC (ECU7) and SAM module.

Terminals of controller	ADEC (X1port)	Remark
Fuel relay output	X1 43	X1 Terminal 28 Connected to negative of battery
Start relay output	X1 37	X1 Terminal 22 Connected to negative of battery

Terminals of controller	SAM (X23 port)	Remark
CAN GND	X23 3	CAN communication shielding line(connect with controller's this terminal only)
CAN(H)	X23 2	Impedance 120Ω connecting line is recommended.
CAN(L)	X23 1	Impedance 120Ω connecting line is recommended.

Engine type: Common J1939

12.14 PERKINS

It is suitable for ADEM3/ ADEM4 engine control module. Engine type is 2306, 2506, 1106, and 2806.

Terminals of controller	Connector	Remark
Fuel relay output	1,10,15,33,34	
Start relay output	-	Connect to starter coil directly
CAN GND	-	CAN communication shielding line(connect with controller's terminal only)
CAN(H)	31	Impedance 120Ω connecting line is recommended.
CAN(L)	32	Impedance 120Ω connecting line is recommended.

Engine type: Perkins

12.15 SCANIA

It is suitable for S6 engine control module. Engine type is DC9, DC12, and DC16.

Terminals of controller	B1 connector	Remark
Fuel relay output	3	
Start relay output	-	Connect to starter coil directly
CAN GND	-	CAN communication shielding line(connect with controller's terminal only)
CAN(H)	9	Impedance 120Ω connecting line is recommended.
CAN(L)	10	Impedance 120Ω connecting line is recommended.

Engine type: Scania

12.16 VOLVO EDC3

Suitable engine control mode is TAD1240, TAD1241, and TAD1242.

Terminals of controller	“Stand alone” connector	Remark
Fuel relay output	H	
Start relay output	E	
Programmable output 1	P	ECU power supply Set programmable output 1 as "ECU power"

Terminals of controller	“Data bus” connector	Remark
CAN GND	-	CAN communication shielding line(connect with controller's terminal only)
CAN(H)	1	Impedance 120Ω connecting line is recommended.
CAN(L)	2	Impedance 120Ω connecting line is recommended.

Engine type: Volvo

▲NOTE: When this engine type is selected, preheating time should be set to at least 3 seconds.

12.17 VOLVO EDC4

Suitable engine types are TD520, TAD520 (optional), TD720, TAD720 (optional), TAD721, TAD722, and TAD732.

Terminals of controller	Connector	Remark
Fuel relay output	Expanded 30A relay, and relay offers battery voltage for terminal14. Fuse is 16A	
Start relay output	-	Connect to starter coil directly
	1	Connected to negative of battery
CAN GND	-	CAN communication shielding line(connect with controller's terminal only)
CAN(H)	12	Impedance 120Ω connecting line is recommended.
CAN(L)	13	Impedance 120Ω connecting line is recommended.

Engine type: VolvoEDC4

12.18 VOLVO-EMS2

Volvo Engine types are TAD734, TAD940, TAD941, TAD1640, TAD1641, and TAD1642.

Terminals of controller	Engine's CAN port	Remark
Programmable output 1	6	ECU stop Set programmable output 1 as "ECU stop"
Programmable output 2	5	ECU power Set programmable output 2 as "ECU power"
	3	Negative power
	4	Positive power
CAN GND	-	CAN communication shielding line(connect with controller's terminal only)
CAN(H)	1(Hi)	Impedance 120Ω connecting line is recommended.
CAN(L)	2(Lo)	Impedance 120Ω connecting line is recommended.

Engine type: Volvo-EMS2, speed regulation can be implemented.

▲ NOTE: When this engine type is selected, preheating time should be set to at least 3 seconds.

12.19 YUCHAI

It is suitable for BOSCH common rail pump engine.

Terminals of controller	Engine 42 pins port	Remark
Fuel relay output	1.40	Connect to engine ignition lock
Start relay output	-	Connect to starter coil directly
CAN GND	-	CAN communication shielding line(connect with controller's this terminal only)
CAN(H)	1.35	Impedance 120Ω connecting line is recommended.
CAN(L)	1.34	Impedance 120Ω connecting line is recommended.

Battery	Engine 2 pins	Remark
Battery negative	1	Wire diameter: 2.5mm ²
Battery positive	2	Wire diameter: 2.5mm ²

Engine type: BOSCH, speed regulation can be implemented.

12.20 WEICHAI

It is suitable for Weichai BOSCH common rail pump engine.

Terminals of controller	Engine port	Remark
Fuel relay output	1.40	Connect to engine ignition lock
Start relay output	1.61	
CAN GND	-	CAN communication shielding line(connect to the controller at this end only)
CAN(H)	1.35	Impedance 120Ω connecting line is recommended.
CAN(L)	1.34	Impedance 120Ω connecting line is recommended.

Engine type: GTSC1, speed regulation can be implemented.

▲ NOTE: If there is any question about connection between controller and ECU communication, please feel free to contact Smartgen's service.

13 USB

Users can set the controller's parameters and monitor the controller's status via USB port using the test software which provided by Smatgen company. USB port is active in stop mode only while at other times it couldn't be detected by PC.

SmartGen

14 FAULT FINDING

Symptoms	Possible Solutions
Controller no response with power.	Check starting batteries; Check controller connection wirings; Check DC fuse.
Genset shutdown	Check the water/cylinder temperature is too high or not; Check DC fuse.
Controller emergency stop	Check emergence stop button is correct or not; Check whether the positive of starting battery is connected with the emergency stop input; Check whether the circuit is open.
Low oil pressure alarm after crank disconnect	Check the oil pressure sensor and its connections.
High water temp. alarm after crank disconnect	Check the temperature sensor and its connections.
Shutdown Alarm in running	Check related switch and its connections according to the information on LCD; Check programmable inputs.
Crank not disconnect	Check fuel oil circuit and its connections; Check starting batteries; Check speed sensor and its connections; Refer to engine manual.
Starter no response	Check starter connections; Check starting batteries.
RS485 COM Fail	Check connections; Check setting of COM port is correct or not; Check RS485's connections of A and B is reverse connect or not; Check RS485 transfer model whether damage or not; Check communication port of PC whether damage.
ECU COM Fail	Check connections of CAN high and low polarity; Check if correctly connected of 120Ω resistor; Check if engine type is correct; Check if connections from controller to engine and outputs setting are correct.
ECU Warning or Shutdown	Get information from LCD of alarm page; If there is detailed alarm, check engine according to description. If not, please refer to engine manual according to SPN alarm code.