

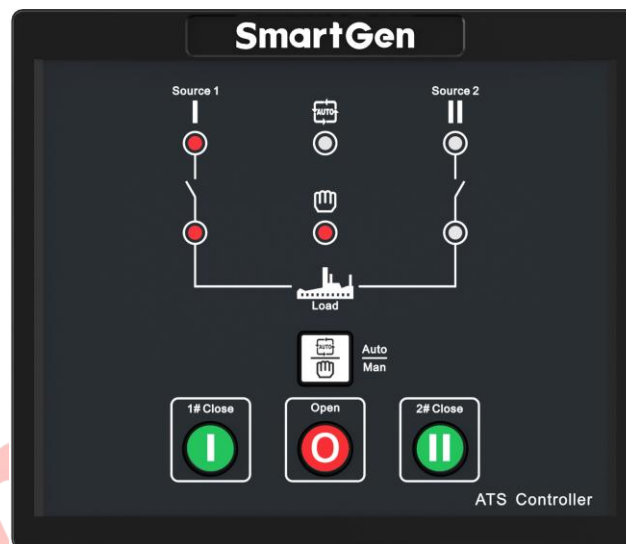

SmartGen
ideas for power

HAT530NC ATS CONTROLLER USER MANUAL



SMARTGEN (ZHENGZHOU) TECHNOLOGY CO., LTD.



Chinese trademark

SmartGen English trademark

SmartGen – make your generator *smart*

SmartGen Technology Co., Ltd.

No.28 Jinsuo Road, Zhengzhou, Henan Province, China

Tel: +86-371-67988888/67981888/67992951
+86-371-67981000(overseas)

Fax: +86-371-67992952

Email: sales@smartgen.cn

Web: www.smartgen.com.cn
www.smartgen.cn

All rights reserved. No part of this publication may be reproduced in any material form (including photocopying or storing in any medium by electronic means or other) without the written permission of the copyright holder.

Applications for the copyright holder's written permission to reproduce any part of this publication should be addressed to SmartGen Technology at the address above.

Any reference to trademarked product names used within this publication is owned by their respective companies.

SmartGen Technology reserves the right to change the contents of this document without prior notice.

Table 1 - Software Version

Date	Version	Note
2020-03-02	1.0	Original release.
2020-04-16	1.1	Add Auto Transfer Auto Restore/Auto Transfer Non-Restore function description.
2020-06-03	1.2	1. Due to the change of the capacity of the closing and opening relay, the capacity label in the revised manual is consistent with the mask. 2. Add auto trans. auto restore/auto trans. non-restore parameter instructions for panel setting steps.
2020-07-30	1.3	Add 3P3W parameter instructions for panel setting steps. 3P3W is only applicable for AC line voltage 230V power supply system and hardware needs to be customized.
2021-04-12	1.4	1. Modify the output contact capacity of 1# and 2# power supply transfer relay; 2. Upgrade the translation, font, format of header and footer.



CONTENT

1	OVERVIEW	4
2	PERFORMANCE AND CHARACTERISTICS	4
3	SPECIFICATION	5
4	OPERATING	6
4.1	OPERATION PANEL	6
4.2	INDICATORS DESCRIPTION	6
5	PANEL BUTTON OPERATION	7
5.1	PANEL OPERATION	7
5.2	MASTER SETTING	7
5.3	AC SYSTEM SETTING	8
5.4	DELAY ADJUSTMENT	8
5.5	FACTORY RESET DELAY VALUE	9
5.6	AUTO TRANS. AUTO RESTORE SETTING	9
6	PARAMETER CONFIGURATION	11
6.1	PARAMETERS TABLE	11
6.2	OUTPUT FUNCTION DESCRIPTION	13
7	OPERATION CONTROL	13
8	WIRING CONNECTION	14
8.1	DESCRIPTION OF CONNECTING TERMINALS	14
8.2	RS485 CONNECTION DESCRIPTION	16
9	ATS POWER SUPPLY	17
10	TYPICAL WIRING DIAGRAM	18
11	INSTALLATION	21
12	FAULT FINDING	21

1 OVERVIEW

HAT530NC ATS Controller is composed of the core microprocessor, which can precisely measure 3-phase/single phase voltage of 2 ways, make accurate judgment on abnormal voltage (power lost, over/under voltage, over/under frequency, loss of phase, phase sequence wrong), and control ATS to transfer after delay is expired. This controller is suitable for NO Breaking ATS and ONE Breaking ATS. When #1 power is abnormal, the controller will send signal to start genset after the “#1 abnormal delay” has expired. “Three remotes” (remote control, remote measurement and remote communication) functions can be implemented with the help of RS485 communication port.

2 PERFORMANCE AND CHARACTERISTICS

Its performance and characteristics are shown as below,

- Collect 2-way 3-phase Voltage and Frequency:

1#	2#
Line voltage (Uab, Ubc, Uca)	Line voltage (Uab, Ubc, Uca)
Phase voltage (Ua, Ub, Uc)	Phase voltage (Ua, Ub, Uc)
Frequency Hz	Frequency Hz
- Over/under voltage, loss of phase, phase sequence wrong, over/under frequency detection function. As default, phase reverse sequence detection and over/under frequency detection are disable; however, users can set the function as you need.
- Controller running parameters can be set by upper computer testing software; At using, controller RS485 port shall connect upper computer by SG72 port module (USB transfers to RS485) or other transfer module.
- Normal delay of 1# power or 2# power can be set (Range: 0-60s); Genset crank delay can be set (Range: 0-3600s).
- Abnormal delay of 1# power or 2# power can be set (Range: 0-60s); Genset stop delay can be set (Range: 0-3600s).
- “1# Master”, “Auto/Manual”, “Each Backup” and “2# Master” can be set via controller front panel, to realize 1# Master power supply, 2# Master power supply or backup for each other to supply power.
- Close output can be set to pulse or continuous output.
- 2-way N wire isolated design.
- Auto/Manual mode transfer. In manual mode, ATS transfer can be implemented via panel pushbutton.
- LEDs mounted on front panel can clearly show ATS running status.
- Forced Open input port has been designed; When the input port is active, the switch will be Breaking position forcedly (woks only for the ATS with Breaking Position).
- AUX.OUTPUT 1 and AUX.OUTPUT 2 can be configured to make it easy to transfer power supply.
- The output contact capacity of 1# and 2# power supply transfer relay (1#CLOSE, 2#CLOSE, OPEN) is 10A AC250V, passive contact, can be directly used in driving switch to transfer.
- The output contact capacity of Genset start relay (GENS START) is 7A AC250V/7A DC28V, passive N/C contact.
- Suitable for various AC systems (3 phase 4-wire, single-phase 2-wire, 2-phase 3-wire and 3-phase 3-wire).

- Modular design, flame retardant ABS plastic shell, pluggable terminal, built-in mounting , compact structure with easy installation.

3 SPECIFICATION

Table 2 – Product Specification

Items	Contents
Operating Voltage	AC170V~277V during AC power L1N1/L2N2 supply.
Power Consumption	<3W (Standby mode: <1W)
AC Voltage Input	
3P4W (ph-N)	AC170V~AC277V(ph-N)
1P2W (ph-N)	AC170V~AC277V (ph-N)
2P3W (ph-N)	AC170V~AC277V(ph-N)
3P3W (ph-ph)	AC170V~AC277V(ph-ph) (Hardware needs to be customized)
Rated Frequency	50/60Hz
1# Close Relay Output	10A AC250V Volts free output
2# Close Relay Output	10A AC250V Volts free output
Open Relay Output	10A AC250V Volts free output
AUX.OUTPUT 1	16A AC250V Volts free output
AUX.OUTPUT 2	16A AC250V Volts free output
Gen Start Relay	7A AC250V Volts free output
1# Close Input	COM2 connect is active.
2# Close Input	COM2 connect is active.
Forced Breaking Input	COM2 connect is active.
Communication	RS485, MODBUS Protocol
Case Dimensions	139mmx120mmx50mm
Panel Cutout	130mmx111mm
Working Conditions	Temperature: (-25~+70)°C; Relative humidity: (20~93)%RH
Storage Condition	Temperature: (-30~+80)°C
Protection Level	IP65 Gasket: when waterproof gasket stalled between controller and control window;
Insulation Strength	Apply AC1.5kV voltage between high voltage terminal and low voltage terminal and the leakage current is not more than 3mA within 1min.
Weight	0.51kg

4 OPERATING

4.1 OPERATION PANEL

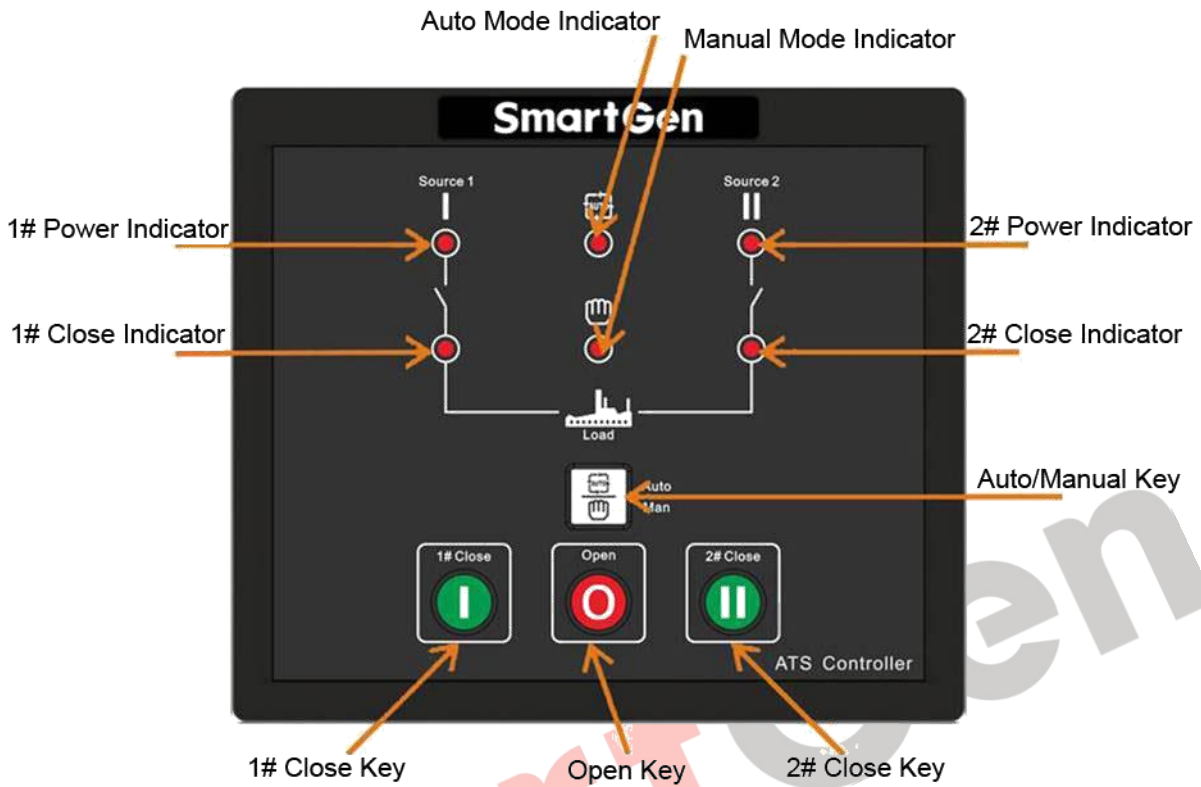

Fig.1 – HAT530NC Front Panel

4.2 INDICATORS DESCRIPTION





Table 3 – Indicator Function Description in Normal Testing Mode

Items	Description
1# Power Indicator	It is illuminated when 1# power is normal; flashing when 1# power state is abnormal; off when there is no 1# power.
2# Power Indicator	It is illuminated when 2# power is normal; flashing when 2# power state is abnormal; off when there is no 2# power.
1# Close Indicator	It is illuminated when 1# power auxiliary contactor is active while off when it is deactivated.
2# Close Indicator	It is illuminated when 2# power auxiliary contact is active while off when it is deactivated.
Auto Mode Indicator	It is illuminated when the controller is in auto mode while off the controller is in manual mode.
Manual Mode Indicator	It is illuminated when the controller is in manual mode while off the controller is in auto mode.

▲ NOTE: More details please refer to the following description of “Panel Button Operation”.





5 PANEL BUTTON OPERATION

5.1 PANEL OPERATION

Pressing and holding the  button for more than 3s, all LEDs are illuminated to enter into lamp test mode; Hold  button and do not release, after 7s all LEDs are flashing (500ms per time) to enter into parameter setting status, and release  button; If users don't want to set the parameters under this status, press and hold  button, all LEDs flash 5 times quickly (once per 200ms) and return back to normal testing mode. At lamp test status, release  key and controller returns to normal testing mode. After entering parameter setting status, if parameter settings are not conducted, controller will automatically return to normal testing mode after 1 minute and 30 seconds.

5.2 MASTER SETTING

First make controller enters parameter setting status, and then conduct the setting.
Procedures of setting "1# Master", "2# Master" and "Each Backup":

- a) Press ,  and  at the same time, when 1#/2# power indicator and auto indicator are illuminated; release the three buttons, then the auto indicator and 2# power indicators extinguished, 1# power indicator illuminated, which means controller master status can be set.
- b) Pressing  can circularly set 3 power supply conditions.
 - **1# Master:** 1# power indicator illuminates and 2# power indicator extinguishes;
 - **2# Master:** 2# power indicator illuminates and 1# power indicator extinguishes;
 - **Each Backup:** 1# power and 2# power indicators are illuminated at the same time;
- c) After adjusting, press , when 1# power indicator, auto indicator and 2# power indicator are illuminated simultaneously, the adjusted master power value has been saved. The controller will back to normal status automatically after all LEDs are flashing 5 times rapidly and controller will work according to the set master status.







Every time the controller is power on, master status can be judged by the following three conditions.

- If 1# power supply indicator flashes rapidly for three times, it indicates 1# power supply is master.
- If 2# power supply indicator flashes rapidly for three times, it indicates 2# power supply is master.
- If 1# and 2# power supply indicators flash simultaneously for three times, it indicates it is backup supply for each other.

5.3 AC SYSTEM SETTING

AC system can be set only when the controller is in parameters setting status.

Procedures of setting “single-phase 2-wire”, “3-phase 4-wire”, “2-phase 3-wire” and “3-phase 3-wire”:

- a) Press ,  and  at the same time, when 1#/2# power indicator and auto indicator are illuminated; release the three buttons, then the auto indicator and 2# power indicators extinguish, 1# power indicator illuminates.
- b) Press , when 1#/2# power indicator and auto indicator are illuminated; release the button, then the auto indicator and 1#/2# power indicators are extinguished simultaneously, which means controller AC system can be set.
- c) Pressing  can circularly set four AC systems.
 - **Single-phase 2-wire:** 1# close indicator illuminates;
 - **3-phase 4-wire:** 1# close indicator, 2# close indicator and manual mode indicator illuminate simultaneously;
 - **2-phase 3-wire:** 1# close indicator and manual mode indicator illuminate simultaneously;
 - **3-phase 3-wire:** 2# close indicator and manual mode indicator illuminate simultaneously.
- d) After adjusting, press , when 1# power indicator, auto indicator and 2# power indicator are illuminating, the adjusted AC system has been saved. The controller will back to normal status automatically after all LEDs are flashing 5 times rapidly and controller will work according to the set AC system.

Once the controller is power on, its AC system can be judged by the following four conditions.

- If 1# close indicator illuminates means **Single-phase 2-wire** system is selected.
- If 1# close indicator, manual mode indicator and 2# close indicator illuminate simultaneously means **3-phase 4-wire** system is selected.
- If 1# close indicator and manual mode indicator illuminate simultaneously means **2-phase 3-wire** system is selected.
- If 2# close indicator and manual mode indicator illuminate simultaneously, it means **3-phase 3-wire** system is selected.



5.4 DELAY ADJUSTMENT

Delay value can be set only when the controller is in parameters setting status.

Adjusting “1# power normal delay” potentiometer (locate nearby the back panel terminal) can set output delay after 1# power supply is normal.

Adjusting “2#power normal delay” potentiometer (locate nearby the back panel terminal) can set output delay after 2#power supply is normal.

Setting Procedures of “1# power abnormal delay” and “2#power abnormal delay”:

- a) Press  and  at the same time, when 1#/2#power indicator and auto indicator are illuminated; release the two buttons, then the auto indicator and 1#/2#power indicators are extinguished

simultaneously which means the delay timer of the controller can be set.



- 1# power abnormal delay: adjust “1# Power Normal Delay” potentiometer;
- 2# power abnormal delay: adjust “2# Power Normal Delay” potentiometer;

b) After adjusting the delays, press . When 1#/2# power indicator and automatic indicator are illuminated simultaneously, the adjusted value has been saved. The controller will back to normal status automatically after all LEDs are flashing 5 times rapidly and controller will work according to the set delay values.

▲NOTE: 1# Normal Delay set value must be no less than 1# Abnormal Delay, otherwise, 1# Normal Delay set value will be forced to set as 1# Abnormal Delay set value. 2# Normal Delay set value must be no less than 2# Abnormal Delay, otherwise, 2# Normal Delay set value will be forced to set as 2# Abnormal Delay set value.

5.5 FACTORY RESET DELAY VALUE

Delay value can be set only when the controller is in parameters setting status.

a) Press  and  at the same time, when 1#/2# power indicator and auto indicator are illuminated; release the two buttons, then the auto indicator and 1#/2# power indicators are extinguished simultaneously which means the delay timer of the controller can be set.



b) After adjusting the delays, press . When 1#/2# power indicator and automatic indicator are illuminated simultaneously, the adjusted value has been saved. The controller will back to normal status automatically after all LEDs are flashing 5 times rapidly and controller will work according to the set delay values.

▲NOTE: Factory settings 1#/2# power abnormal delay 5s and genset stop delay 90s.

5.6 AUTO TRANS. AUTO RESTORE SETTING

First of all, make controller enter parameter setting status and then conduct the setting.

Set “Auto Trans. Auto Restore/Auto Trans. Non-Restore” Steps:

a) Press  and  at the same time, when 1#/2# power indicator and auto indicator are illuminated, release the two buttons, then the auto indicator and 2# power indicator are extinguished, 1# power indicator and 1# close indicator are illuminated, which means the auto trans. auto restore of the controller can be set.

b) Press  can circularly set two states:

Auto trans. non-restore when 1# power indicator and 1# close indicator are illuminated, 2# power indicator and 2# close indicator are extinguished.

Auto trans. auto restore when 2# power indicator and 2# close indicator are illuminated, 1# power indicator and 1# close indicator are extinguished.

c) After adjustment, press . When # 1 # 2 power indicator and auto indicator are illuminated at the same time, it indicates that the set parameter value has been saved successfully; all indicators on the panel flash 5 times quickly to return to normal test mode. The controller works according to the set state of auto trans. auto-restore/auto trans. non-restore.



NOTE: Turn on the power supply of the controller, auto trans. auto-restore/auto trans. non-restore set by the controller can be judged by the following two situations:

If 1# power indicator and 1# close indicator flash quickly three times at the same time, it is auto trans. non-restore.

If 2# power indicator and 2# close indicator flash quickly three times at the same time, it is auto trans. auto restore.

SmartGen

6 PARAMETER CONFIGURATION

6.1 PARAMETERS TABLE

Table 4 – Parameters Setting Table

No.	Item	Range	Default	Description
01	1# Normal Delay	(0-60)s	Can be set via controller potentiometer	It is the delay of #1 power from voltage abnormal to voltage normal. Generally, it is 10s.
02	1# Abnormal Delay	(0-60)s	5	It is the delay of #1 power from voltage normal to voltage abnormal.
03	2# Normal Delay	(0-60)s	Can be set via controller potentiometer	It is the delay of #2 power from voltage abnormal to voltage normal. Generally, it is 10s.
04	2# Abnormal Delay	(0-60)s	5	It is the delay of #2 power from voltage normal to voltage abnormal.
05	Close Delay	(0-20)s	5	Closing relay output pulse. If set as zero, it is continuous output.
06	Open Delay	(1-20)s	5	Open relay output pulse.
07	Transfer Interval	(0-60)s	1	It is the delay waiting time from 1# power open to 2# power close or from 2# power open to 1# power close.
08	Exceed Transfer	(0-20.0)s	0.0	It is the extra output delay of the close relay after the closing signal has received.
09	Start Delay	(0-3600)s	1	When voltage is abnormal, start delay begins; start signal is initiated after the delay has expired.
10	Stop Delay	(0-3600)s	90	When starting, if the mains voltage is normal, stop delay begins; stop signal is initiated after the delay has expired.
11	AC System	(0-3)	0	0. 3-phase 4-wire 1. 2-phase 3-wire 2. Single phase 3. 3-phase 3-wire
12	Rated Volt	(100-240)V	230	AC system rated voltage.
13	Rated Frequency	(50.0-60.0) Hz	50.0	To offer standards for detecting of over/under frequency.
14	Over Volt Enable	(0-1)	1	0: Disable; 1: Enable
15	Over Voltage	(100-120)%	115	Voltage upper limit; it is abnormal when the voltage has exceed the set value.



No.	Item	Range	Default	Description
16	Over Volt Return	(100-120)%	113	Voltage upper limit return value; it is normal only when the voltage fallen below the set value.
17	Under voltage	(70-100)%	75	Voltage lower limit; it is abnormal when the voltage has fallen below the set value.
18	Under Volt Return	(70-100)%	77	Voltage lower limit return value; it is normal only when the voltage has exceeded the set value.
19	Over Freq. Enable	(0-1)	0	0: Disable; 1: Enable
20	Over Frequency	(100-120)%	110	Frequency upper limit; it is abnormal when the frequency has exceed the set value.
21	Over Freq. Return	(100-120)%	104	Frequency upper limit return value; it is normal only when the frequency fallen below the set value.
22	Under Freq. Enable	(0-1)	0	0: Disable; 1: Enable
23	Under Frequency	(80-100)%	90	Frequency lower limit; it is abnormal when the frequency has fallen below the set value.
24	Under Freq. Return	(80-100)%	96	Frequency lower limit return value; it is normal only when the frequency has exceeded the set value.
25	Loss of Phase	(0-1)	1	0: Disable; 1: Enable
26	Reverse Phase Sequence	(0-1)	0	0: Disable; 1: Enable
27	Master-Slave Set	(0-2)	0	0. 1# Master; 1. 2# Master; 2. Each Backup
28	Auto Trans. Auto Restore Set	(0-1)	1	0: Auto Trans. Non Restore 1: Auto Trans. Auto Restore
29	Neutral Position	(0-1)	0	0. One Breaking; 1. No Breaking
30	Aux. Output 1	(0-23)	20	More details please refer to the following OUTPUT FUNCTION DESCRIPTION
31	Aux. Output 2	(0-23)	23	More details please refer to the following OUTPUT FUNCTION DESCRIPTION

NOTE1: Parameters above are configured via PC software of SmartGen. The PC programming connection uses RS485 interface of SG72 module to connect with RS485 interface of controller.

NOTE2: "1# Normal Delay" and "2# Normal Delay" can be set only via the potentiometer which locates nearby the back panel terminal. "1# Abnormal Delay" and "2# Abnormal Delay" can be set via the PC software or potentiometer which locates nearby the back panel terminal. AC system and priority selection can be set via panel button or PC software while other parameters can be set via PC software only.

NOTE3: 1# Normal Delay set value must be no less than 1# Abnormal Delay, otherwise, 1# Normal Delay set value will be forced set as 1# Abnormal Delay set value. The matters need attention of 2# is same as 1#. If motor driving type ATS (e.g. SOCOMEC VS) is applied, the Close delay and Open delay must be no less than 5s; If magnet driving type ATS (e.g. SOCOMEC ATySM3s) is applied, the Exceed Transfer delay must be set as 0.

NOTE4: "Priority Select" in last version is changed to "Master-Slave Set"; Set contents "0: 1# Priority; 1: 2# Priority; 2: No Priority" is changed to "0: 1# Master; 1: 2# Master; 2: Each Backup".

6.2 OUTPUT FUNCTION DESCRIPTION



Table 5 – Output Function Description

Items	Description
00. Not used	Invalid.
01. 1# Normal volt	It will output when 1# voltage is normal.
02. 1# Abnormal volt	It will output when 1# voltage is abnormal.
03. 2# Normal volt	It will output when 2# voltages is normal.
04. 2# Abnormal volt	It will output when 2# voltages is abnormal.
05. 1#2# Abnormal volt	It will output when 1#2# voltages are abnormal simultaneously.
06. Auto Mode	In will output in automatic mode.
07. Manual Mode	In will output in manual mode.
08. Gens start (N/O)	When generator starts output (Relay closed).
09. Gens start (N/C)	When generator starts output (Relay released).
10. 1# Close Output	1# Switch ON signal output.
11. Open Output	Switch OFF signal output.
12. 2# Close Output	2# Switch ON signal output.
13. Reserved	
14. Reserved	
15. Reserved	
16. 1# Close Status Output	The close status of 1# switch.
17. 2# Close Status Output	The close status of 2# switch.
18. Reserved	
19. Reserved	
20. ATS Power A Phase	ATS power supply.
21. ATS Power B Phase	
22. ATS Power C Phase	
23. ATS Power N Phase	

7 OPERATION CONTROL

When controller is running, pressing  key can set the controller as Auto mode or Manual mode (indicate by automatic and manual indicators).

In Auto mode, controller can transfer the load to 1# or 2# power. When it is set to Auto Trans. Auto Restore, master power is normal, and controller will transfer to master power end in priority; When it is set to Auto Trans. Non Restore, controller only transfers to backup power, and master power transfer can only be controlled manually. Each Backup is for two powers to be backup for each other. When 1# power is abnormal, and 2# power is normal, switch will transfer to 2# power supply, and vice versa. When it is set to Each Backup, controller will not detect auto trans. auto restore settings.

In Manual mode, press  key, load will be transferred to 1# power supply; Press  to

disconnect load supply; and press  key, load will be transferred to 2# power supply.

8 WIRING CONNECTION

8.1 DESCRIPTION OF CONNECTING TERMINALS

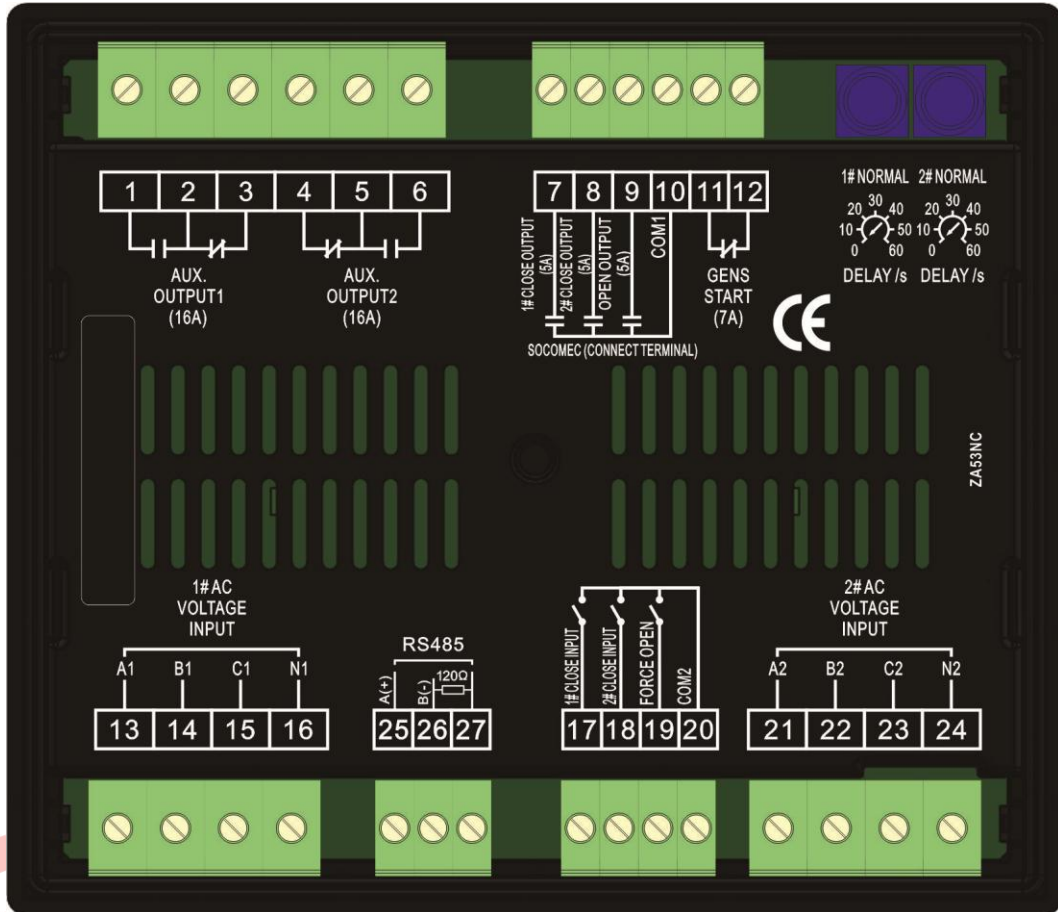

Fig.2 – HAT530NC Rear Panel



Table 6 - Terminal Function Table

No.	Items	Description	Remark
1	Aux. Output 1	NO	Default: ATS Power A Phase Volt-free relay contact output; Rated 16A.
2		COM	
3		NC	
4	Aux. Output 2	NC	Default: ATS Power N Phase Volt-free relay contact output; Rated 16A.
5		COM	
6		NO	
7	1# Close Output	Volt-free relay contact output;	N/C contact output; Rated 10A.
8	2# Close Output	Volt-free relay contact output;	N/C contact output; Rated 10A.
9	Open Output	Volt-free relay contact output;	N/C contact output; Rated 10A.
10	COM1	Output COM of close switch and open switch	COM1
11	GEN Start	Volt-free relay contact output;	N/C contact output; Rated 7A.
12			
13	A1	1# AC 3-phase 4 wire voltage input	For single phase, only connect A1, N1.
14	B1		
15	C1		
16	N1		
17	1# Close Input	Detection of 1# ATS closing status; auxiliary contact input	Connect COM2 is active.
18	2# Close Input	Detection of 2# ATS closing status; auxiliary contact input	Connect COM2 is active.
19	Force Open	When active, the ATS is in Neutral Position.	Connect COM2 is active.
20	COM Port	Input COM	COM2
21	A2	2# AC 3-phase 4 wire voltage input	For single phase, only connect A2, N2.
22	B2		
23	C2		
24	N2		
25	A(+)	RS485 communication port	Connected already inside 120Ω impedance matched resistor
26	B(-)		
27	120Ω Resistor	RS485 impedance matched resistor	Users need to connect this with No. 25 terminal based on field network, used to connect inside 120Ω impedance matched resistor.

8.2 RS485 CONNECTION DESCRIPTION

Connection between RS485 and adaptor is as below:

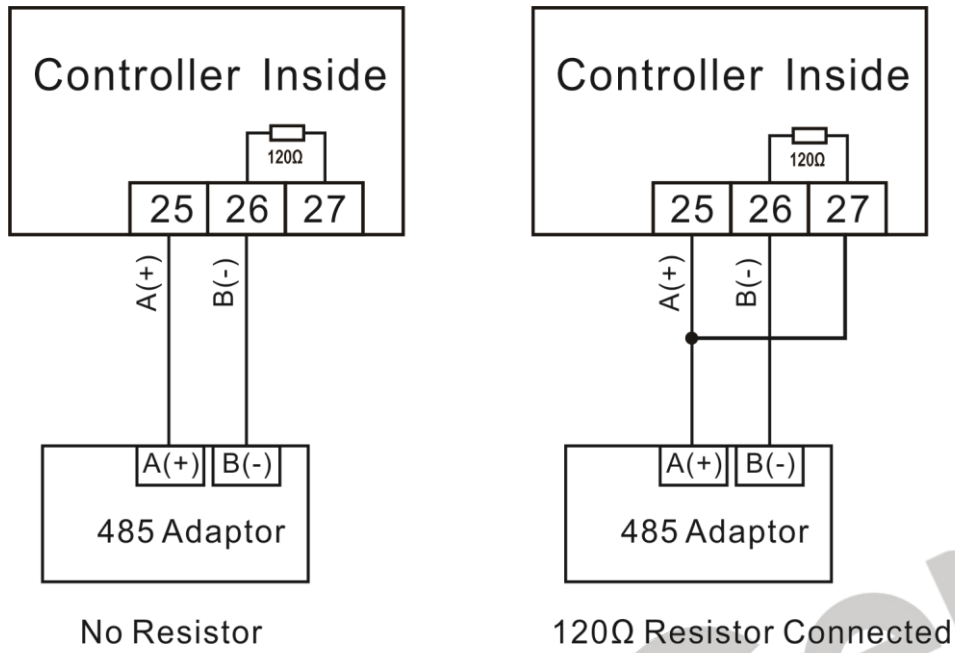

Fig. 3 - RS485 Connection Diagram

SmartGen

9 ATS POWER SUPPLY

The power of ATS is supplied by controller smartly, as long as one voltage is normal, this can ensure ATS power supply normally and can be transferred properly.

Users should select power supply voltage (phase voltage or line voltage) based on ATS type. If choose phase voltage, connect the phase voltage of 1# and 2# (e.g. A phase) to normally close (Pin3) and normally open (Pin1) contact of auxiliary output 1; connect N phase of 1# and 2# to normally close (Pin4) and normally open (Pin6) contact of auxiliary output 2. And then connect the common output of auxiliary output 1 and auxiliary output 2 to ATS power supplies. When controller power is ON, the default configuration of auxiliary output 1 is "ATS power A" while auxiliary output 2 is "ATS power N". If the ATS power supplied by Line Voltage, same procedures as above but change phase N to phase voltage and the auxiliary output 2 should be configured as "ATS power B". Parameters can be set via PC software. Wiring diagrams are shown as following:

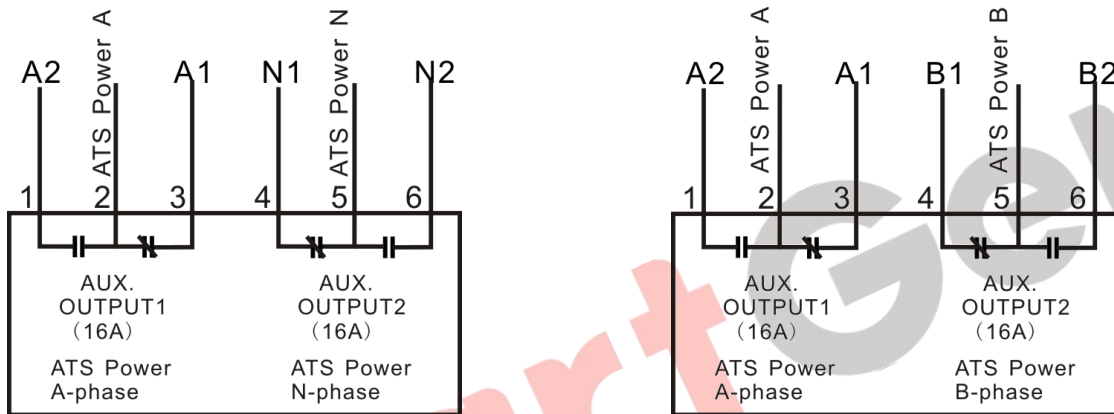

Fig. 4 - ATS phase voltage and line voltage power supply

NOTE: If there is no need to control ATS Power Supply, then the above terminals are not connected and the Auxiliary Output 1 and Auxiliary Output 2 should be set as "Not used". If the Auxiliary output 1 and Auxiliary Output 2 are used for something function other than the "ATS Power Supply", corresponding function items should be set.

10 TYPICAL WIRING DIAGRAM

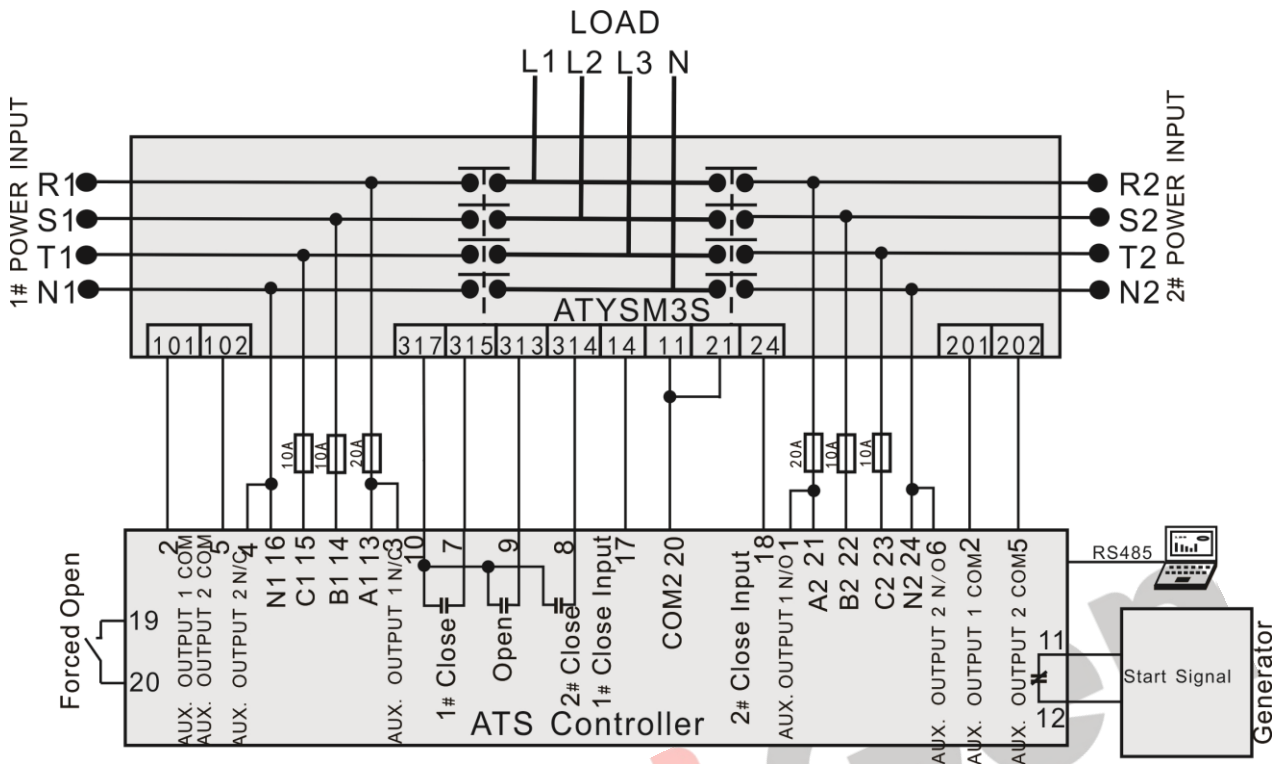

Fig. 5 - ATySM3s Wiring Diagram

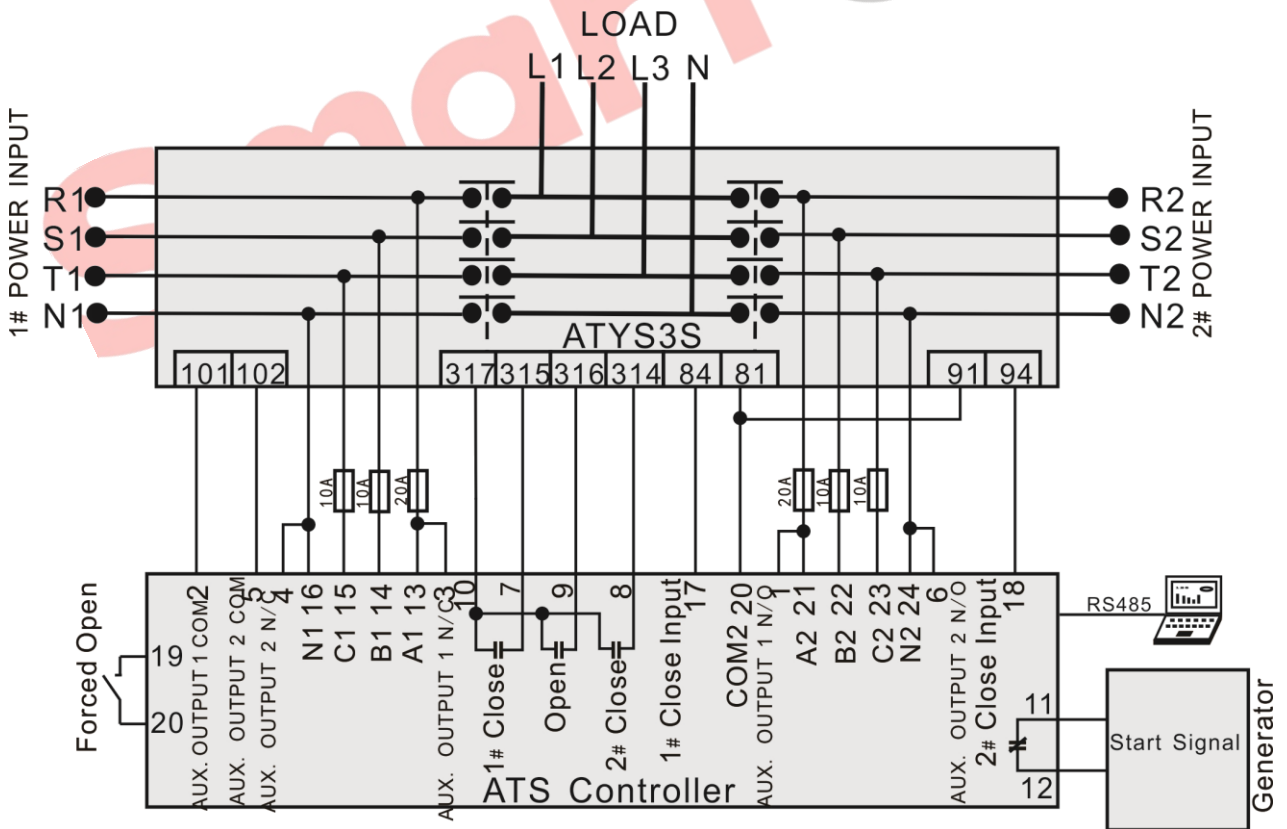

Fig. 6 - ATyS3s Wiring Diagram

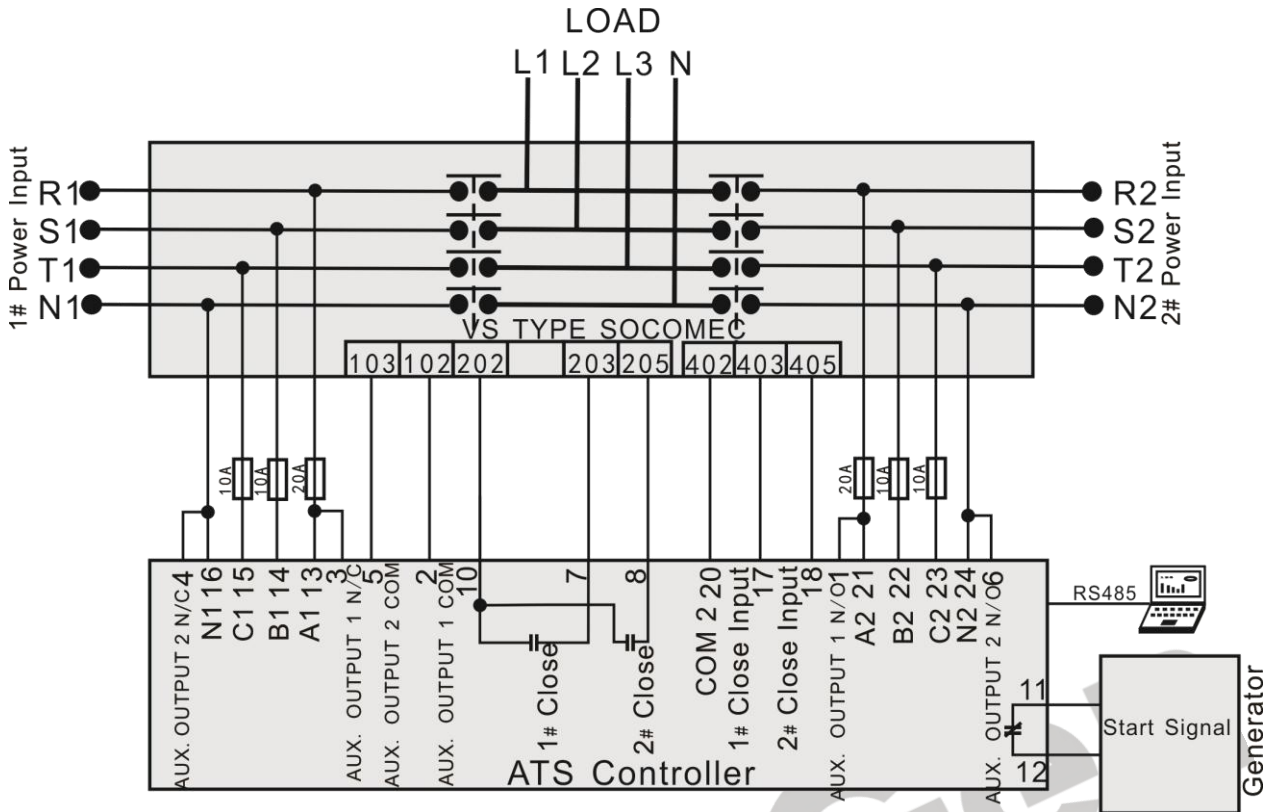

Fig. 7 - SOCOMEC VS Wiring Diagram

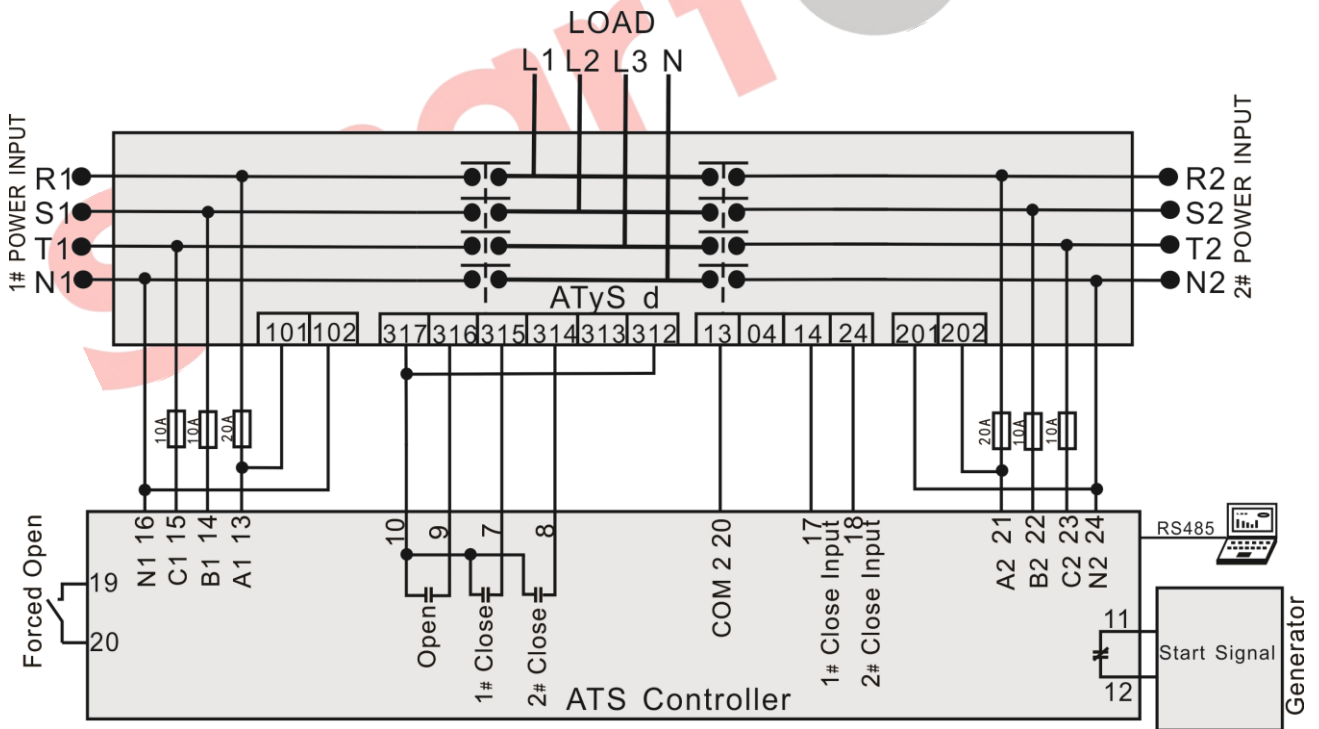

Fig. 8 - ATyS d Wiring Diagram

NOTE: The diagram is for reference only. The actual wiring shall follow the ATS instruction. Users should choose proper fuse capacity according to the actual power consumption. If SOCOMEC VS is applied, the Close delay and Open delay must be no less than 5s (Default: 5s).

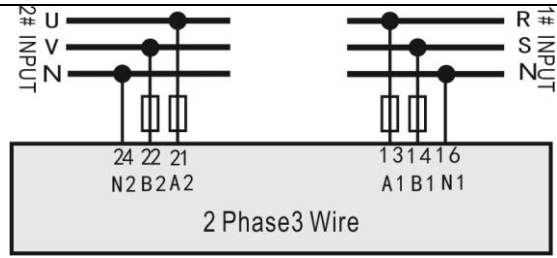

Fig. 9 - 2-phase 3-wire Wiring Diagram

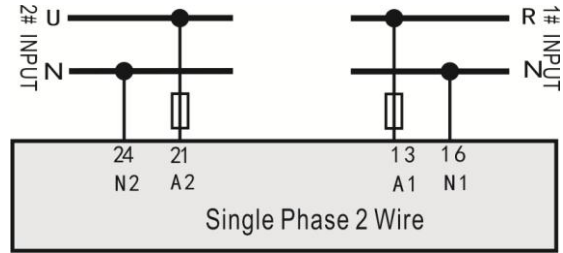

Fig. 10 - Single phase 2-wire Wiring Diagram

NOTE: Above pictures take the AC 220V voltage as example. If AC 110V voltage is applied in actual use, please contact with SmartGen technical staff to get the specific wiring methods.

SmartGen

11 INSTALLATION

Unit: mm

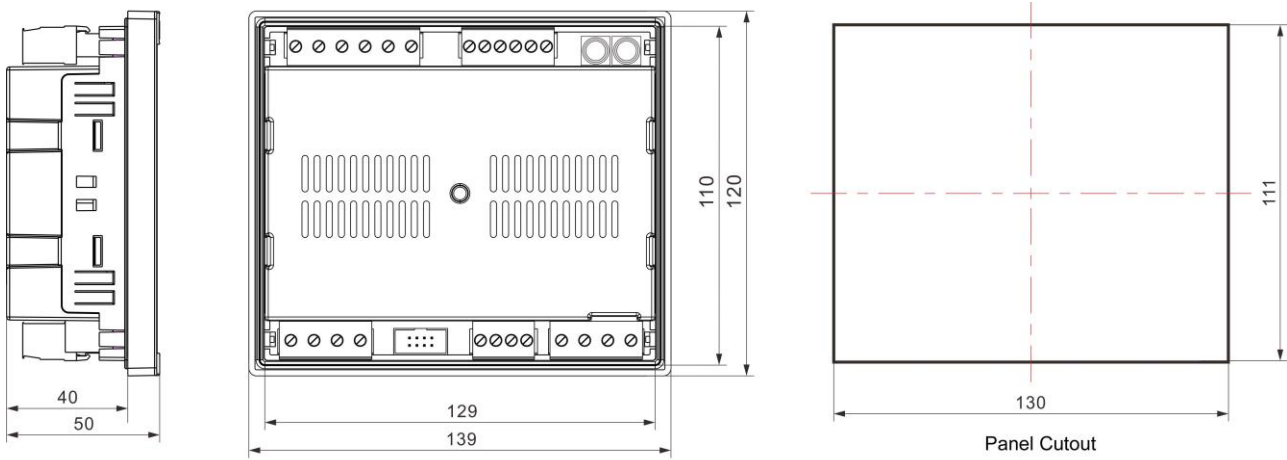

Fig. 11 - Installation Dimensions

12 FAULT FINDING

Table 7 – Fault Finding

Symptom	Possible Solutions
Controller no response with power.	Check controller wiring.
ATS not transfer	Check ATS; Check the connection wirings between the controller and the ATS.
Electrical parameters detection error	Check controller wiring; Modify electrical parameters detection value.
PC software communication failure	Check communication port setting and connections.