

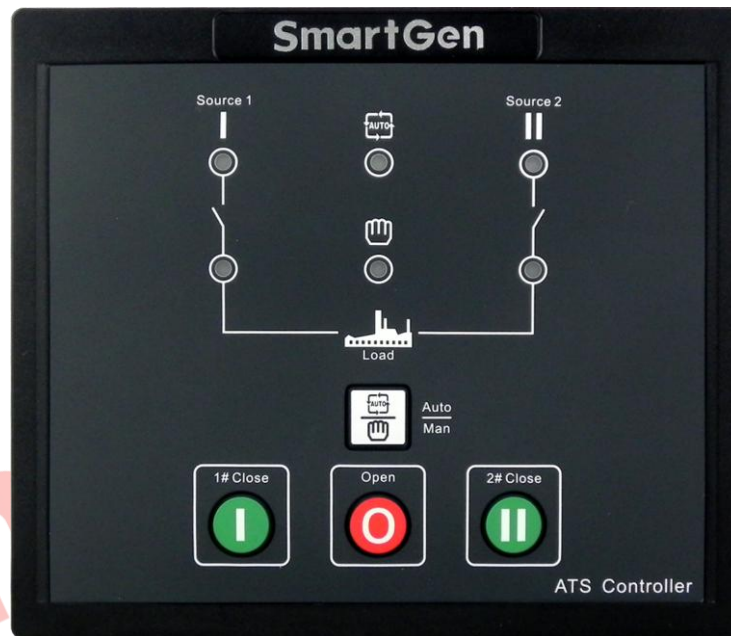

SmartGen
ideas for power

HAT530N ATS CONTROLLER USER MANUAL



SMARTGEN (ZHENGZHOU) TECHNOLOGY CO., LTD.



Chinese trademark

SmartGen English trademark

SmartGen — make your generator *smart*

SmartGen Technology Co., Ltd.

No.28 Jinsuo Road

Zhengzhou City

Henan Province

P. R. China

Tel: 0086-371-67988888/67981888

0086-371-67991553/67992951

0086-371-67981000(overseas)

Fax: 0086-371-67992952

Web: www.smartgen.com.cn

www.smartgen.cn

Email: sales@smartgen.cn

All rights reserved. No part of this publication may be reproduced in any material form (including photocopying or storing in any medium by electronic means or other) without the written permission of the copyright holder.

Applications for the copyright holder's written permission to reproduce any part of this publication should be addressed to SmartGen Technology at the address above.

Any reference to trademarked product names used within this publication is owned by their respective companies.

SmartGen Technology reserves the right to change the contents of this document without prior notice.

Table 1 - Software Version

Date	Version	Note
2016-07-04	1.0	Original release.
2018-05-25	1.1	Modify function of terminal 1 as normally open, and terminal 3 as normally close.
2019-05-22	1.2	Add AtyS d wiring diagram.



CONTENT

1	OVERVIEW	4
2	PERFORMANCE AND CHARACTERISTICS.....	4
3	SPECIFICATION	5
4	OPERATING.....	6
4.1	OPERATION PANEL.....	6
4.2	INDICATORS DESCRIPTION.....	6
5	PANEL BUTTON OPERATION	7
5.1	PANEL OPERATION	7
5.2	PRIORITY SETTING.....	7
5.3	AC SYSTEM SETTING.....	8
5.4	DELAY ADJUSTMENT.....	8
5.5	FACTORY RESET DELAY VALUE	9
6	PARAMETER CONFIGURATION	10
6.1	PARAMETERS TABLE.....	10
6.2	OUTPUT FUNCTION DESCRIPTION.....	12
7	OPERATION CONTROL.....	12
8	DESCRIPTION OF CONNECTING TERMINALS.....	13
9	ATS POWER SUPPLY	14
10	TYPICAL WIRING DIAGRAM	15
11	INSTALLATION.....	18
12	FAULT FINDING	18

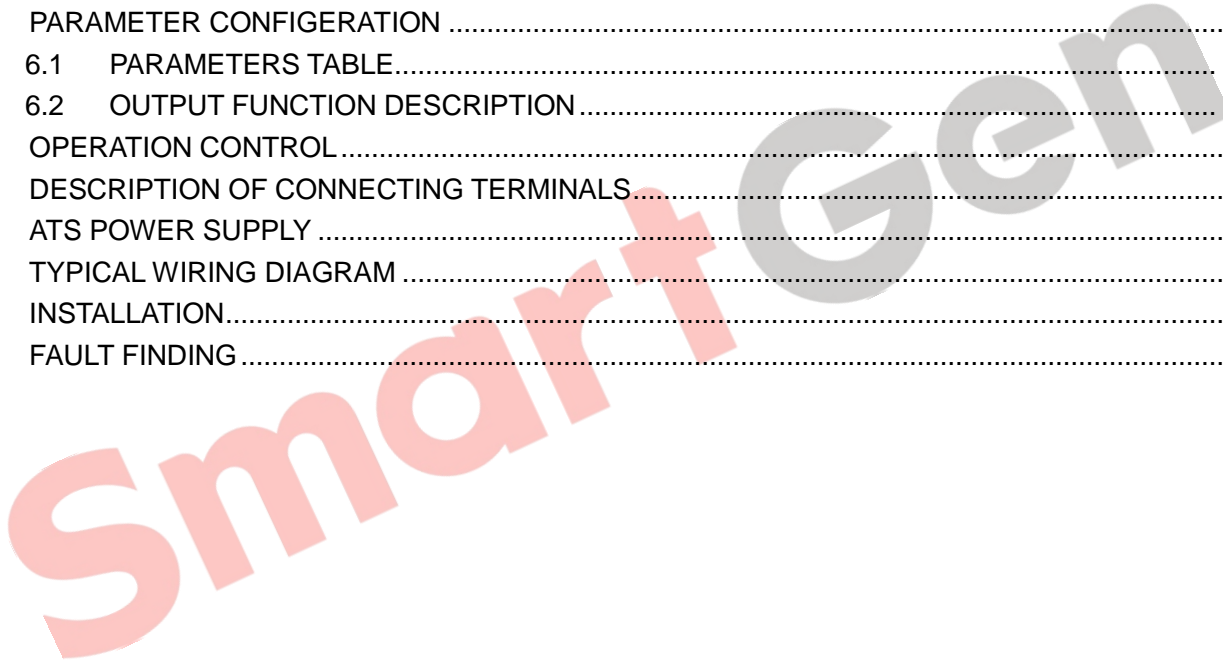

1 OVERVIEW

The powerful Microprocessor contained within the HAT530N ATS controller allows for precision voltage (2-way 3-phase/single phase) measuring and make accurate judgment on abnormal voltage (power lost, over/under voltage, over/under frequency, loss of phase, phase sequence wrong) and control ATS to transfer after the delay has expired. This controller is suitable for NO Breaking ATS and ONE Breaking ATS. When #1 power is abnormal, the controller will send signal to start genset after the “#1 abnormal delay” has expired. “Three remote” (remote control, remote measurement and remote communication) functions can be implemented with the help of LINK communication port.

2 PERFORMANCE AND CHARACTERISTICS

Its performance and characteristics are shown as below,

- Measure and display 2-way 3 phase Voltage and Frequency:

1#		2#	
Line voltage	(Uab, Ubc, Uca)	Line voltage	(Uab, Ubc, Uca)
Phase voltage	(Ua, Ub, Uc)	Phase voltage	(Ua, Ub, Uc)
Frequency	Hz	Frequency	Hz
- Over/under voltage, loss of phase, phase sequence wrong, over/under frequency protection function. As default, phase reverse sequence protection and over/under frequency protection are disable; however, users can set the protection function as need.
- Parameters can be set via PC software using SG72 module (USB to LINK) or other converse module.
- The voltage normal delay of 1# or 2# can be set in (0~60) seconds and the Genset start delay can be set in (0~3600) seconds.
- The voltage abnormal delay of 1# or 2# can be set in (0~60) seconds and the Genset stop delay can be set in (0~3600) seconds.
- “1# power priority”, “Auto/Manual”, “No priority” and “2# power priority” can be set via controller front panel.
- Closing output signal can be set as on intervals or as continuous output.
- Applicable for 2 isolated neutral line.
- Auto/Manual mode. In manual mode, ATS transfer can be implemented via panel pushbutton.
- LEDs mounted on front panel can clearly show ATS running status.
- Forced Open input port been designed; When the input port is active, the switch will be Breaking position forcedly (woks for the ATS with Breaking Position).
- AUX.OUTPUT 1 and AUX.OUTPUT 2 can be configured to make it easy to transfer power supply.
- The output contact capacity of 1# and 2# power supply transfer relay (1#CLOSE, 2#CLOSE) is 5A AC250V, passive contact, can be directly used in driving switch to transfer.
- The output contact capacity of Genset start relay (GENS START) is 7A AC250V/7A DC28V, passive N/C contact.
- Suitable for various AC systems (3 phase 4-wires, 2-phase 3-wires and single-phase 2-wire).
- Modular design, retardant ABS plastic shell, pluggable terminal, built-in mounting , compact structure with easy installation.

3 SPECIFICATION

Table 2 – Product Specification

Items	Contents
Operating Voltage	AC170V~277V during AC power L1N1/L2N2 supply.
Power Consumption	<3W (Standby mode: <1W)
AC Voltage Input	
3P4W (ph-N)	AC170V~AC277V(ph-N)
1P2W (ph-N)	AC170V~AC277V (ph-N)
2P3W (ph-N)	AC170V~AC277V(ph-N)
Rated Frequency	50/60Hz
1# Close Relay Output	5A AC250V Volts free output
2# Close Relay Output	5A AC250V Volts free output
Open Relay Output	5A AC250V Volts free output
AUX.OUTPUT 1	16A AC250V Volts free output
AUX.OUTPUT 2	16A AC250V Volts free output
Gen Start Relay	7A AC250V Volts free output
1# Close Input	COM2 connect is active.
2# Close Input	COM2 connect is active.
Forced Breaking Input	COM2 connect is active.
Communication	LINK interface, MODBUS Protocol
Case Dimensions	139mmx120mmx50mm
Panel Cutout	130mmx111mm
Working Conditions	Temperature: (-25~+70)°C; Relative humidity: (20~93)%RH
Storage Condition	Temperature: (-25~+70)°C
Protection Level	IP65 Gasket
Insulation Strength	Apply AC2.2kV voltage between high voltage terminal and low voltage terminal; The leakage current is not more than 3mA within 1min.
Weight	0.51kg

4 OPERATING

4.1 OPERATION PANEL

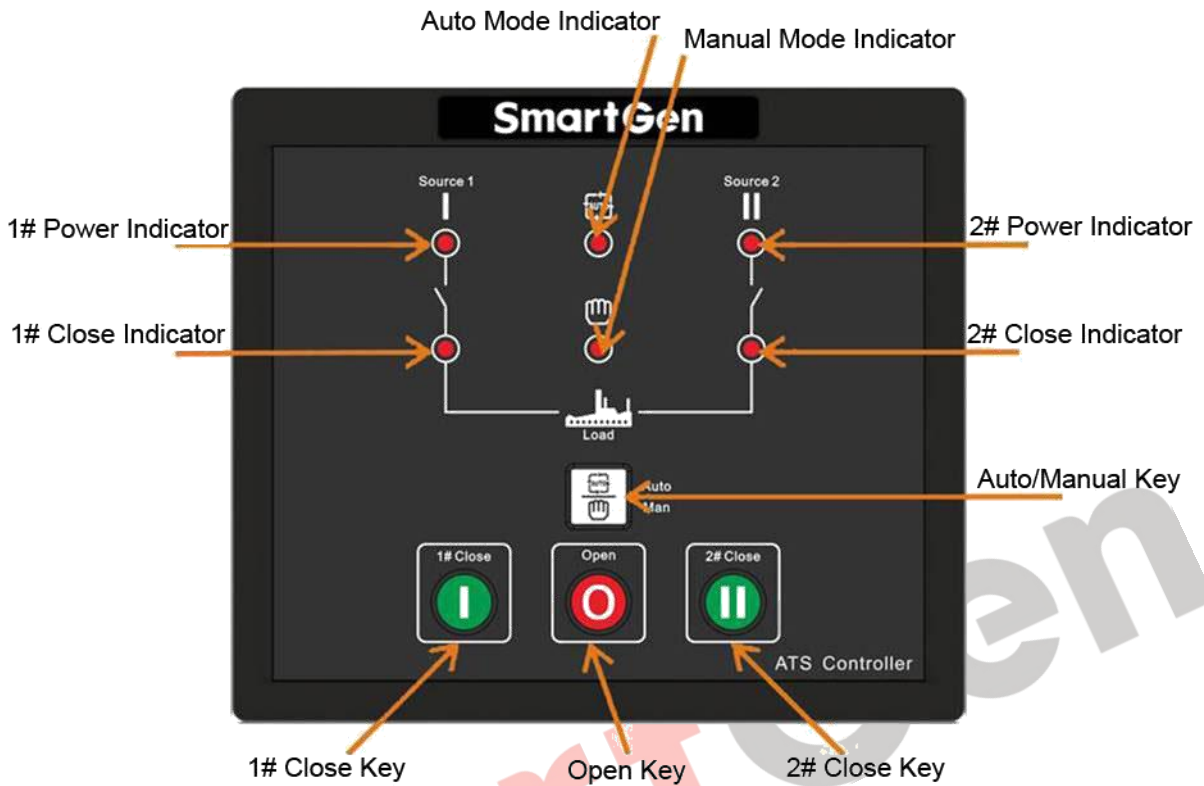

Fig.1 – HAT530N Panel Drawing

4.2 INDICATORS DESCRIPTION





Table 3 – Indicator Function Description in Normal Testing Mode

Items	Description
1# Power Indicator	It is illuminated when 1# power is normal; flashing when 1# power state is abnormal; off when there is no 1# power.
2# Power Indicator	It is illuminated when 2# power is normal; flashing when 2# power state is abnormal; off when there is no 2# power.
1# Close Indicator	It is illuminated when 1# power auxiliary contactor is active while off when it is deactivated.
2# Close Indicator	It is illuminated when 2# power auxiliary contact is active while off when it is deactivated.
Auto Mode Indicator	It is illuminated when the controller is in auto mode while off the controller is in manual mode.
Manual Mode Indicator	It is illuminated when the controller is in manual mode while off the controller is in auto mode.

▲ NOTE: More details please refer to the following description of “Panel Button Operation”.

5 PANEL BUTTON OPERATION

5.1 PANEL OPERATION





Pressing and holding the  button for more than 3s, all LEDs are illuminated to enter into lamp test mode; under this mode, the controller will back to normal status automatically after release the  button. Pressing and holding the  button for more than 7s, all LEDs are flashing (500ms per time) to enter into parameter setting status, users can set the parameters after release the  button. If users don't want to set the parameters under this status:

- 1) Pressing and holding the  button again until all LEDs are flashing 5 times rapidly (200ms per time) which means the controller enter into normal status;
- 2) Or the controller will back to normal status automatically about 90s later.

5.2 PRIORITY SETTING

Power priority can be set only when the controller is in parameters setting status.

Procedures of setting "1# power priority", "2# power priority" and "No priority":

- a) Press ,  and  at the same time, when 1#/2# power indicator and auto indicator are illuminated; release the three buttons, then the auto indicator and 2# power indicators extinguish, 1# power indicator illuminates, which means controller priority can be set.
- b) Pressing  can circularly set 3 priority conditions of power supply.
 - **1# Power Priority:** 1# power indicator illuminates and 2# power indicator extinguishes;
 - **2# Power Priority:** 2# power indicator illuminates and 1# power indicator extinguishes;
 - **No Priority:** 1# power and 2# power indicators are illuminating at the same time;
- c) After adjusting, press , when 1# power indicator, auto indicator and 2# power indicator are illuminated, the adjusted power priority has been saved. The controller will back to normal status automatically after all LEDs are flashing 5 times rapidly and controller will work according to the priority.







Once the controller is power on, its priority can be judged by the following three conditions.

 - If 1# power supply indicator flashes rapidly for three times, indicating 1# power supply for priority transfer.
 - If 2# power supply indicator flashes rapidly for three times, indicating 2# power supply for priority transfer.
 - If 1# and 2# power supply indicators flash simultaneously for three times, indicating there is no priority transfer.

5.3 AC SYSTEM SETTING

AC system can be set only when the controller is in parameters setting status.

Procedures of setting “Single-phase 2-wire”, “3-phase 4-wire” and “2-phase 3-wire”:

- a) Press ,  and  at the same time, when 1#/2# power indicator and auto indicator are illuminated; release the three buttons, then the auto indicator and 2# power indicators extinguish, 1# power indicator illuminates.
- b) Press , when 1#/2# power indicator and auto indicator are illuminated; release the button, then the auto indicator and 1#/2# power indicators are extinguished simultaneously, which means controller AC system can be set.
- c) Pressing  can circularly set three AC systems.
 - **Single-phase 2-wire:** 1# close indicator illuminates;
 - **3-phase 4-wire:** 1# close indicator, 2# close indicator and manual mode indicator illuminates simultaneously;
 - **2-phase 3-wire:** 1# close indicator and manual mode indicator illuminates simultaneously;
- d) After adjusting, press , when 1# power indicator, auto indicator and 2# power indicator are illuminating, the adjusted AC system has been saved. The controller will back to normal status automatically after all LEDs are flashing 5 times rapidly and controller will work according to the set AC system.

Once the controller is power on, its AC system can be judged by the following three conditions.

- If 1# close indicator illuminates means **Single-phase 2-wire** system is selected.
- If 1# close indicator, manual mode indicator and 2# close indicator illuminate simultaneously means **3-phase 4-wire** system is selected.
- If 1# close indicator and manual mode indicator illuminate simultaneously means **2-phase 3-wire** system is selected.



5.4 DELAY ADJUSTMENT

Delay value can be set only when the controller is in parameters setting status.

Adjusting “1# power normal delay” potentiometer (locate nearby the back panel terminal) can set output delay after 1# power supply is normal.

Adjusting “2#power normal delay” potentiometer (locate nearby the back panel terminal) can set output delay after 2#power supply is normal.

Setting Procedures of “1# power abnormal delay” and “2#power abnormal delay”:



- a) Press  and  at the same time, when 1#/2#power indicator and auto indicator are illuminated; release the two buttons, then the auto indicator and 1#/2#power indicators are extinguished simultaneously which means the delay timer of the controller can be set.
 - 1# power abnormal delay: adjust “1# Power Normal Delay” potentiometer;
 - 2#power abnormal delay: adjust “2#Power Normal Delay” potentiometer;
- b) After adjusting the delays, press . When 1#/2#power indicator and automatic indicator are

illuminated simultaneously, the adjusted value has been saved. The controller will back to normal status automatically after all LEDs are flashing 5 times rapidly and controller will work according to the set delay values.

NOTE: 1# Normal Delay set value must be no less than 1# Abnormal Delay, otherwise, 1# Normal Delay set value will be forced set as 1# Abnormal Delay set value. The matters need attention of 2# is same as 1#.

5.5 FACTORY RESET DELAY VALUE

Delay value can be set only when the controller is in parameters setting status.

a) Press  and  at the same time, when 1#/2# power indicator and auto indicator are illuminated; release the two buttons, then the auto indicator and 1#/2# power indicators are extinguished simultaneously which means the delay timer of the controller can be set.

b) After adjusting the delays, press . When 1#/2# power indicator and automatic indicator are illuminated simultaneously, the adjusted value has been saved. The controller will back to normal status automatically after all LEDs are flashing 5 times rapidly and controller will work according to the set delay values.

NOTE: Factory settings 1#/2# power abnormal delay 5s and genset stop delay 90s.

SmartGen

6 PARAMETER CONFIGURATION

6.1 PARAMETERS TABLE

Table 4 – Parameters Setting Table

No.	Item	Range	Default	Description
01	1# Normal Delay	(0-60)s	Can be set via controller potentiometer	It is the delay of #1 power from voltage abnormal to voltage normal. Generally, it is 10s.
02	1# Abnormal Delay	(0-60)s	5	It is the delay of #1 power from voltage normal to voltage abnormal.
03	2# Normal Delay	(0-60)s	Can be set via controller potentiometer	It is the delay of #2 power from voltage abnormal to voltage normal. Generally, it is 10s.
04	2# Abnormal Delay	(0-60)s	5	It is the delay of #1 power from voltage normal to voltage abnormal.
05	Close Delay	(0-20)s	5	Closing relay output pulse. If set as zero, it is continuous output.
06	Open Delay	(1-20)s	5	Open relay output pulse.
07	Transfer Interval	(0-60)s	1	It is the delay from 1# power open to 2# power close or from 2# power open to 1# power close.
08	Exceed Transfer	(0-20.0)s	0.0	It is the extra output delay of the close relay after the closing signal has received.
09	Start Delay	(0-3600)s	1	When voltage is abnormal, start delay begins; start signal is initiated after the delay has expired.
10	Stop Delay	(0-3600)s	90	When starting, if the mains voltage is normal, stop delay begins; stop signal is initiated after the delay has expired.
11	AC System	(0-2)	0	0. 3-phase 4 wires 1. 2-phase 3 wires 2. Single phase
12	Rated Volt	(100-240)V	230	AC system rated voltage.
13	Rated Frequency	(50.0-60.0) Hz	50.0	To offer standards for detecting of over/under frequency.
14	Over Volt Enable	(0-1)	1	0: Disable; 1: Enable
15	Over Voltage	(100-120)%	115	Voltage upper limit; it is abnormal when the voltage has exceeded the set value.
16	Over Volt Return	(100-120)%	113	Voltage upper limit return value; it is normal only when the voltage fallen below the set value.



No.	Item	Range	Default	Description
17	Under voltage	(70-100)%	75	Voltage lower limit; it is abnormal when the voltage has fallen below the set value.
18	Under Volt Return	(70-100)%	77	Voltage lower limit return value; it is normal only when the voltage has exceeded the set value.
19	Over Freq. Enable	(0-1)	0	0: Disable; 1: Enable
20	Over Frequency	(100-120)%	110	Frequency upper limit; it is abnormal when the frequency has exceed the set value.
21	Over Freq. Return	(100-120)%	104	Frequency upper limit return value; it is normal only when the frequency fallen below the set value.
22	Under Freq. Enable	(0-1)	0	0: Disable; 1: Enable
23	Under Frequency	(80-100)%	90	Frequency lower limit; it is abnormal when the frequency has fallen below the set value.
24	Under Freq. Return	(80-100)%	96	Frequency lower limit return value; it is normal only when the frequency has exceeded the set value.
25	Loss of Phase	(0-1)	1	0: Disable; 1: Enable
26	Reverse Phase Sequence	(0-1)	0	0: Disable; 1: Enable
27	Priority Select	(0-2)	0	0. 1# Priority; 1. 2# Priority; 2. NO Priority
28	Neutral Position	(0-1)	0	0. One Breaking; 1. No Breaking
29	Aux. Output 1	(0-23)	20	More details please refer to the following OUTPUT FUNCTION DESCRIPTION
30	Aux. Output 2	(0-23)	23	More details please refer to the following OUTPUT FUNCTION DESCRIPTION

NOTE1: Parameters above are configured via PC software of SmartGen. The PC programming connection is use LINK interface of SG72 module connect with LINK interface of controller.

NOTE2: "1# Normal Delay" and "2# Normal Delay" can be set only via the potentiometer which locate nearby the back panel terminal. "1# Abnormal Delay" and "2# Abnormal Delay" can be set via the PC software or potentiometer which locate nearby the back panel terminal. AC system and priority selection can be set via panel button or PC software while other parameters can be set via PC software only.



NOTE3: 1# Normal Delay set value must be no less than 1# Abnormal Delay, otherwise, 1# Normal Delay set value will be forced set as 1# Abnormal Delay set value. The matters need attention of 2# is same as 1#. If motor driving type ATS (e.g. SOCOMEC VS) is applied, the Close delay and Open delay must be no less than 5s; If magnet driving type ATS (e.g. SOCOMEC ATySM3s) is applied, the Exceed Transfer delay must be set as 0.

6.2 OUTPUT FUNCTION DESCRIPTION

Table 5 – Output Function Description

Items	Description
00. Not used	Invalid.
01. 1# Normal volt	It will output when 1# voltage is normal.
02. 1# Abnormal volt	It will output when 1# voltage is abnormal.
03. 2# Normal volt	It will output when 2# voltages is normal.
04. 2# Abnormal volt	It will output when 2# voltages is abnormal.
05. 1#2# Abnormal volt	It will output when 1#2# voltages are abnormal simultaneously.
06. Auto Mode	In will output in automatic mode.
07. Manual Mode	In will output in manual mode.
08. Gens start (N/O)	When generator starts output (Relay closed).
09. Gens start (N/C)	When generator starts output (Relay released).
10. 1# Close Output	1# Switch ON signal output.
11. Open Output	Switch OFF signal output.
12. 2# Close Output	2# Switch ON signal output.
13. Reserved	
14. Reserved	
15. Reserved	
16. 1# Close Status Output	The close status of 1# switch.
17. 2# Close Status Output	The close status of 2# switch.
18. Reserved	
19. Reserved	
20. ATS Power A Phase	ATS power supply.
21. ATS Power B Phase	
22. ATS Power C Phase	
23. ATS Power N Phase	

7 OPERATION CONTROL

When controller is running, pressing  key can set the controller as Auto mode or Manual mode (indicate by automatic and manual indicators). In Auto mode, controller can transfer the load to 1# or 2# power. In Manual mode, press  key, load will be transferred to 1# power supply; press  key, load will be transferred to 2# power supply.

8 DESCRIPTION OF CONNECTING TERMINALS

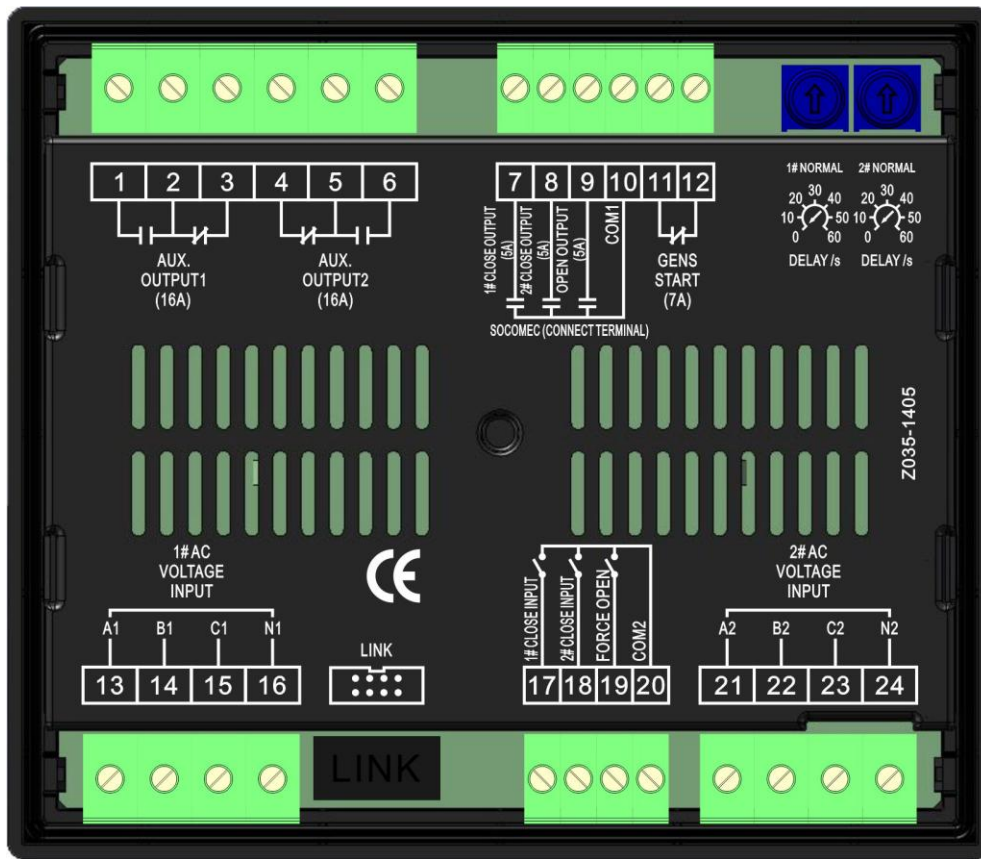

Fig.2 – HAT530N Rare Panel Drawing



Table 6 - Terminal Function Table

No.	Items	Description	Remark
1	Aux. Output 1	NO	Default: ATS Power A Phase Volt-free relay contact output; Rated 16A.
2		COM	
3		NC	
4	Aux. Output 2	NC	Default: ATS Power N Phase Volt-free relay contact output; Rated 16A.
5		COM	
6		NO	
7	1# Close Output	Volt-free relay contact output;	Normally Open Output; Rated 5A.
8	2# Close Output	Volt-free relay contact output;	Normally Open Output; Rated 5A.
9	Open Output	Volt-free relay contact output;	Normally Open Output; Rated 5A.
10	COM1	Output COM of close switch and open switch	COM1
11	GEN Start	Volt-free relay contact output;	Normally Close Output; Rated 7A.
12			
13	A1	1# AC 3-phase 4 wire voltage input	For single phase, only connect A1, N1.
14	B1		
15	C1		
16	N1		
17	1# Close Input	Detection of 1# ATS closing status; auxiliary contact input	Connect COM2 is active.
18	2# Close Input	Detection of 2# ATS closing status; auxiliary contact input	Connect COM2 is active.
19	Force Open	When active, the ATS is in Neutral Position.	Connect COM2 is active.
20	COM Port	Input COM	COM2
21	A2	2# AC 3-phase 4 wire voltage input	For single phase, only connect A2, N2.
22	B2		
23	C2		
24	N2		
LINK	Communication Port	Communicate with PC/Program update	

9 ATS POWER SUPPLY

The power of ATS is supplied by controller, as long as one power is normal, this can ensure ATS power supply normally and can be transferred properly.

Users should select power supply voltage (phase voltage or line voltage) based on ATS type. If choose phase voltage, connect the phase voltage of 1# and 2# (e.g. A phase) to normally close (Pin3) and normally open (Pin1) contact of auxiliary output 1; connect N phase of 1# and 2# to normally close (Pin4) and normally open (Pin6) contact of auxiliary output 2. And then connect the common output of auxiliary output 1 and auxiliary output 2 to ATS power supplies. When controller power is ON, the default configuration of auxiliary output 1 is "ATS power A" while s auxiliary output 2 is "ATS power N". If the ATS power supplied by Line Voltage, same procedures as above but change phase N to phase voltage and

the auxiliary output 2 should be configured as “ATS power B”. Parameters can be set via PC software. Wiring diagrams are shown as following:

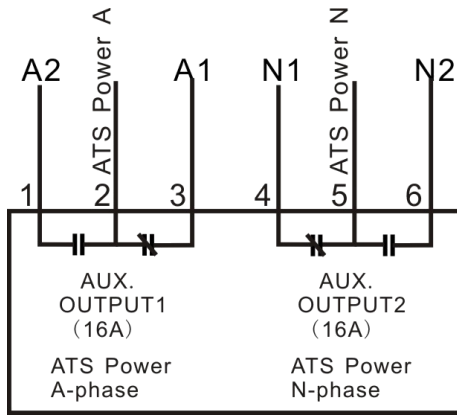

Fig. 3 - ATS phase voltage power supply

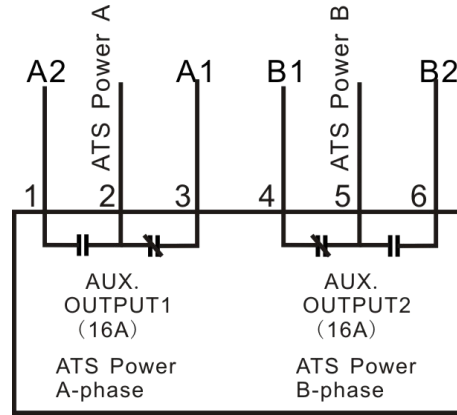

Fig. 4 - ATS line voltage power supply

NOTE: If there is no need to control ATS Power Supply, then the above terminals are not connected and the Auxiliary Output 1 and Auxiliary Output 2 should be set as “Not used”. If the Auxiliary output 1 and Auxiliary Output 2 are used for something function other than the “ATS Power Supply”, corresponding function items should be set.

10 TYPICAL WIRING DIAGRAM

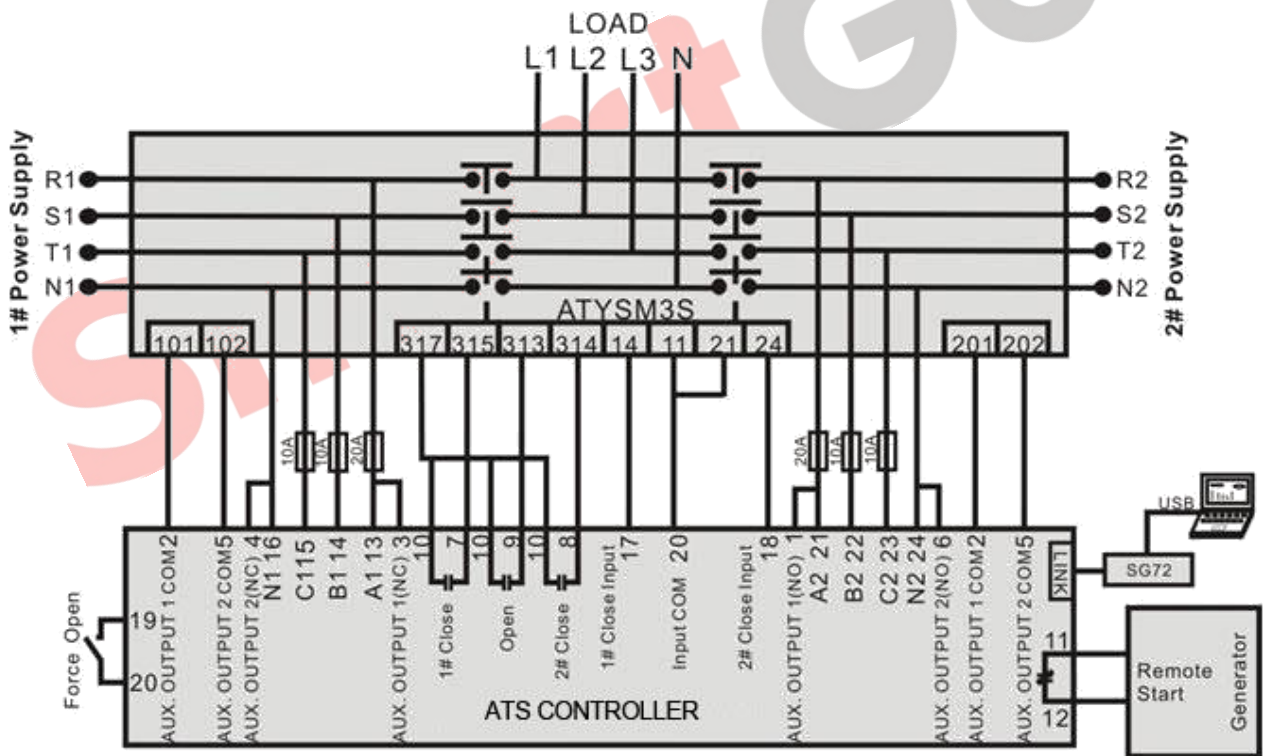

Fig. 5 - ATySM3s Wiring Diagram

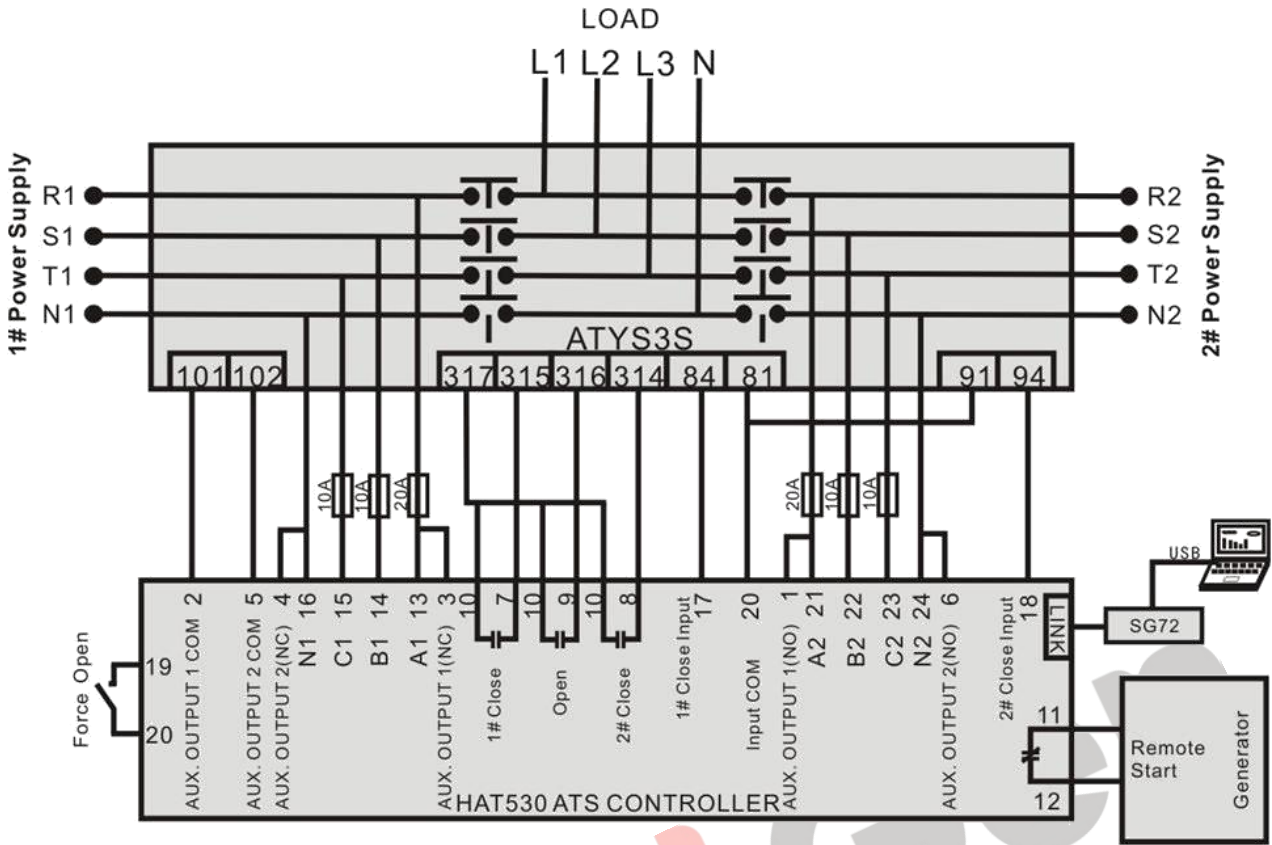

Fig. 6 - ATYS3s Wiring Diagram

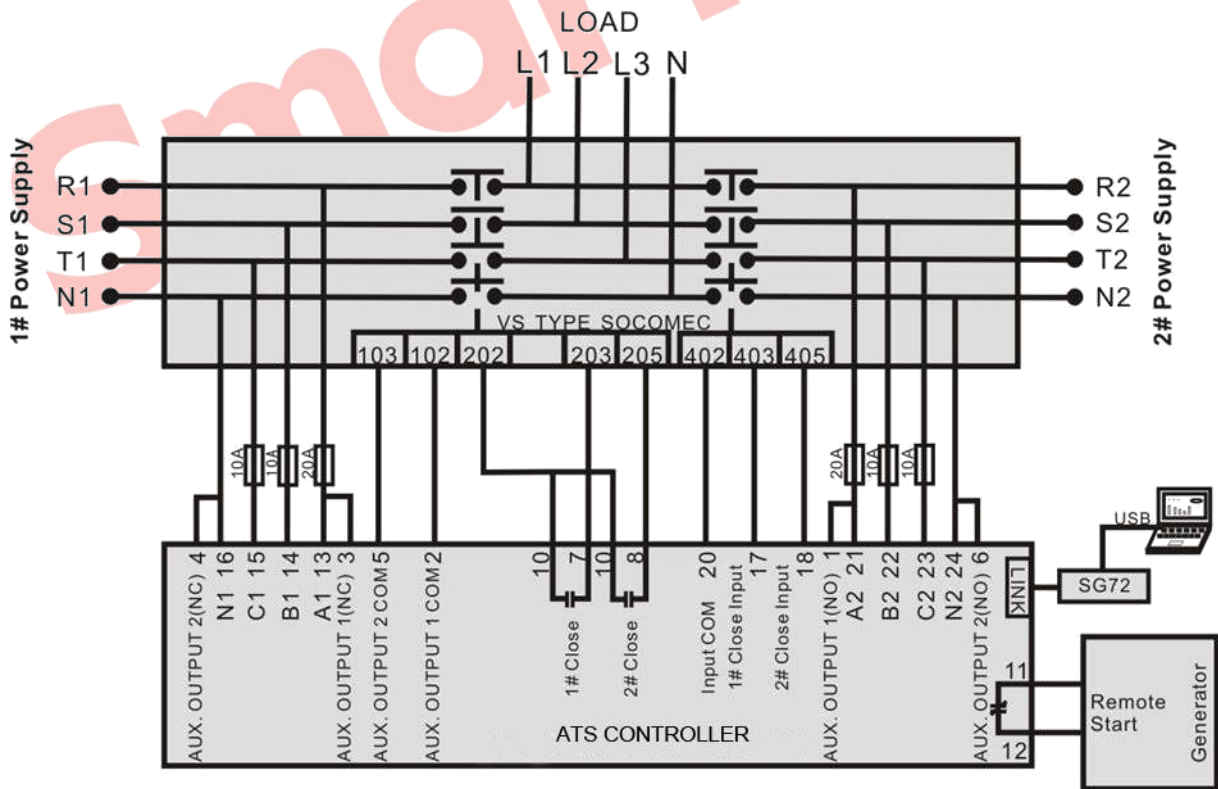

Fig. 7 - SOCOME VS Wiring Diagram

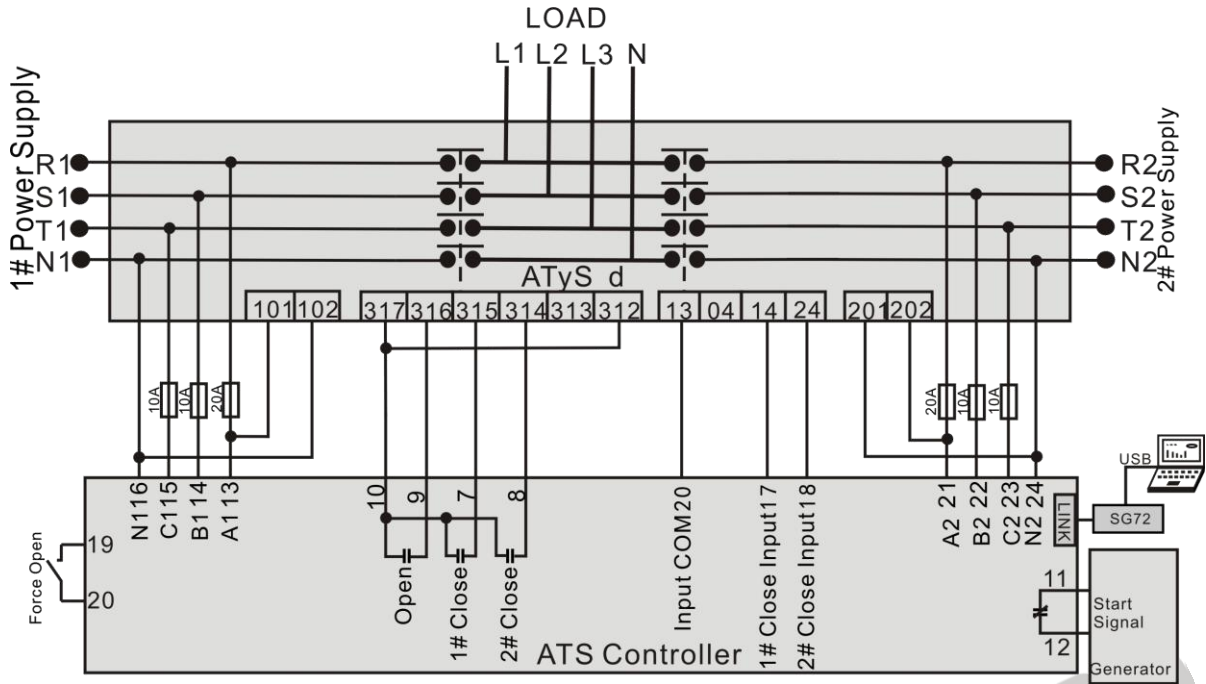

Fig. 8 – AtyS d Wiring Diagram

NOTE: The diagram is for reference only. The actual wiring shall follow the ATS instruction. Users should choose proper fuse capacity according to the actual power consumption. If SOCOMEC VS is applied, the Close delay and Open delay must be no less than 5s (Default: 5s).

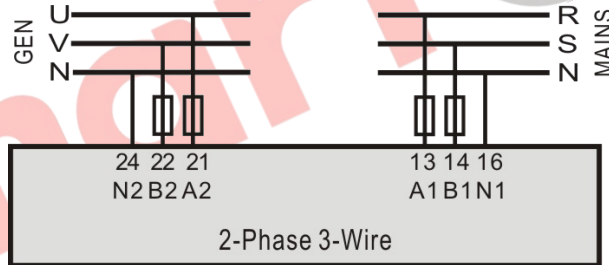

Fig. 9 - 2-phase 3-wire Wiring Diagram

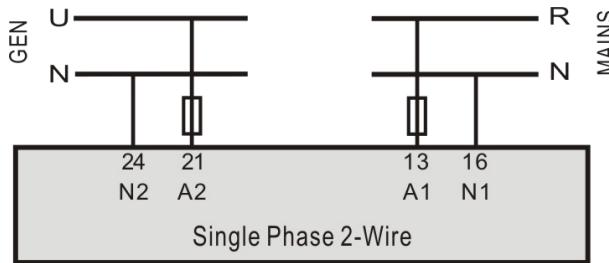

Fig. 10 - Single phase 2-wire Wiring Diagram

NOTE: Above pictures take the AC 220V voltage as example. If AC 110V voltage is applied in actual use, please contact with SmartGen technical staff to get the specific wiring methods.

11 INSTALLATION

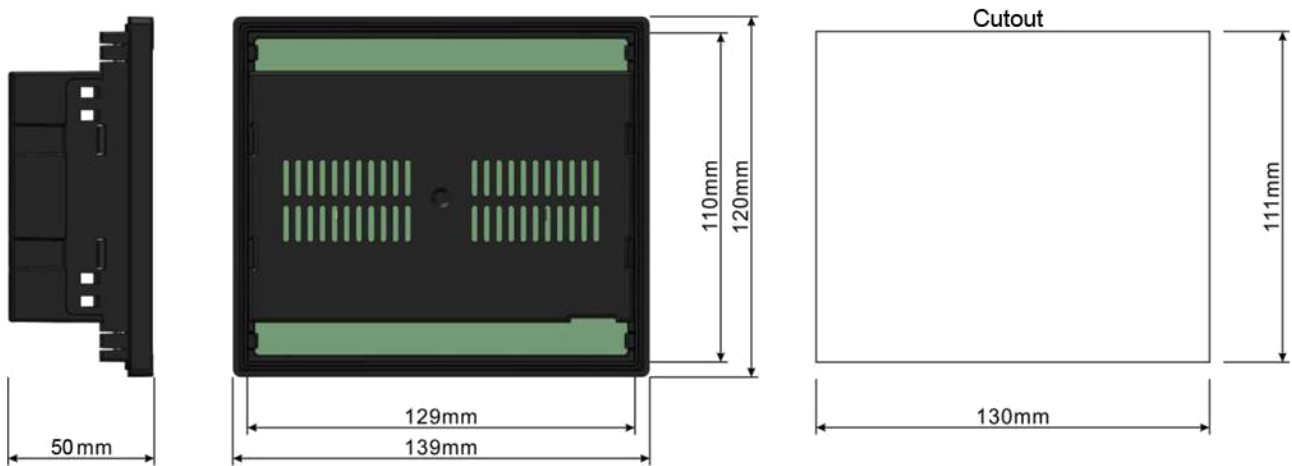

Fig. 11 - Installation Dimensions

12 FAULT FINDING

Table 7 – Fault Finding

Symptom	Possible Solutions
Controller no response with power.	Check controller wiring.
Genset running while ATS not transfer	Check ATS; Check the connection wirings between the controller and the ATS.
Electrical parameters detection error	Check controller wiring; Modify electrical parameters detection value.
PC software communication failure	Check communication port setting and connections.