

SmartGen

MAKING CONTROL SMARTER

HAT520N

ATS CONTROLLER

USER MANUAL

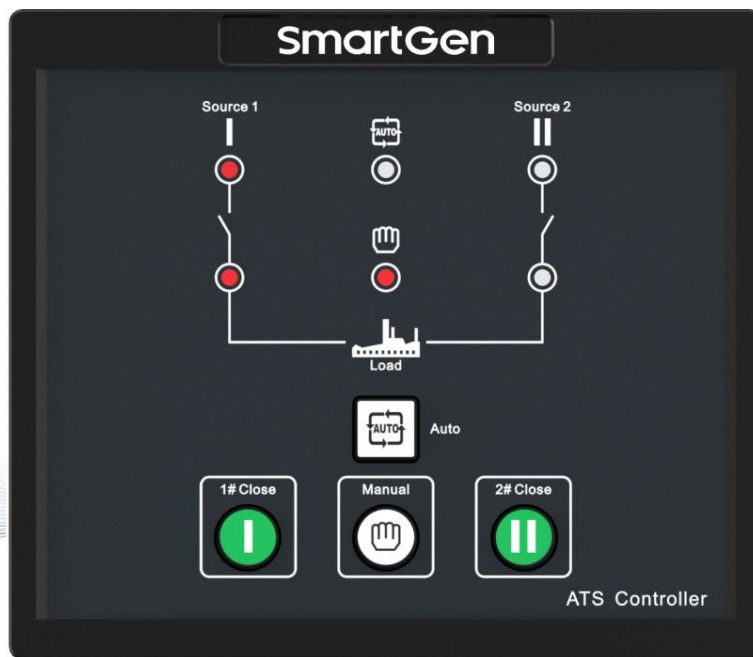

郑州众智科技股份有限公司
SMARTGEN(ZHENGZHOU)TECHNOLOGY CO.,LTD.

SmartGen 众智 Chinese trademark

SmartGen English trademark

SmartGen – make your generator *smart*

SmartGen Technology Co., Ltd.

No.28 Jinsuo Road

Zhengzhou

Henan Province

P. R. China

Tel: +86-371-67988888/67981888/67992951

+86-371-67981000 (overseas)

Fax: +86-371-67992952

Web: www.smartgen.com.cn/

www.smartgen.cn/

Email: sales@smartgen.cn

All rights reserved. No part of this publication may be reproduced in any material form (including photocopying or storing in any medium by electronic means or other) without the written permission of the copyright holder.

Applications for the copyright holder's written permission to reproduce any part of this publication should be addressed to Smartgen Technology at the address above.

Any reference to trademarked product names used within this publication is owned by their respective companies.

SmartGen Technology reserves the right to change the contents of this document without prior notice.

Table 1 Software Version

Date	Version	Note
2016-06-24	1.0	Original release.
2017-08-02	1.1	Modified SGQ-M diagram: added a cross wire dot of 1# close and A1 and a cross wire dot of 2# close and A2.
2020-04-17	1.2	Added Auto Trans. Auto Restore/Auto Trans. Non-Restore function description.
2020-06-05	1.3	Added Auto Trans. Auto Restore/Auto Trans. Non-Restore parameters instruction for panel setting steps.
2022-06-15	1.4	Updated manual format and company logo.

CONTENT

1	OVERVIEW.....	4
2	PERFORMANCE AND CHARACTERISTICS.....	4
3	SPECIFICATION	5
4	PANEL DESCRIPTION.....	6
4.1	PANEL OPERATION	6
4.2	INDICATOR LIGHT FUNCTION DESCRIPTION.....	6
5	PANEL OPERATION SETTING.....	7
5.1	PANEL OPERATION	7
5.2	MASTER SETTING.....	7
5.3	AC SYSTEM SETTING	8
5.4	DELAY ADJUSTMENT	9
5.5	RESTORE FACTORY DEFAULT	9
5.6	AUTO TRANS. AUTO RESTORE SETTING	10
6	PARAMETER CONFIGURATION.....	11
7	OPERATION CONTROL.....	13
8	DESCRIPTION OF CONNECTING TERMINALS.....	13
8.1	BACK PANEL	13
8.2	TERMINAL FUNCTION DESCRIPTION	14
9	TYPICAL APPLICATION DIAGRAM.....	15
10	INSTALLATION.....	17
11	FAULT FINDING.....	17

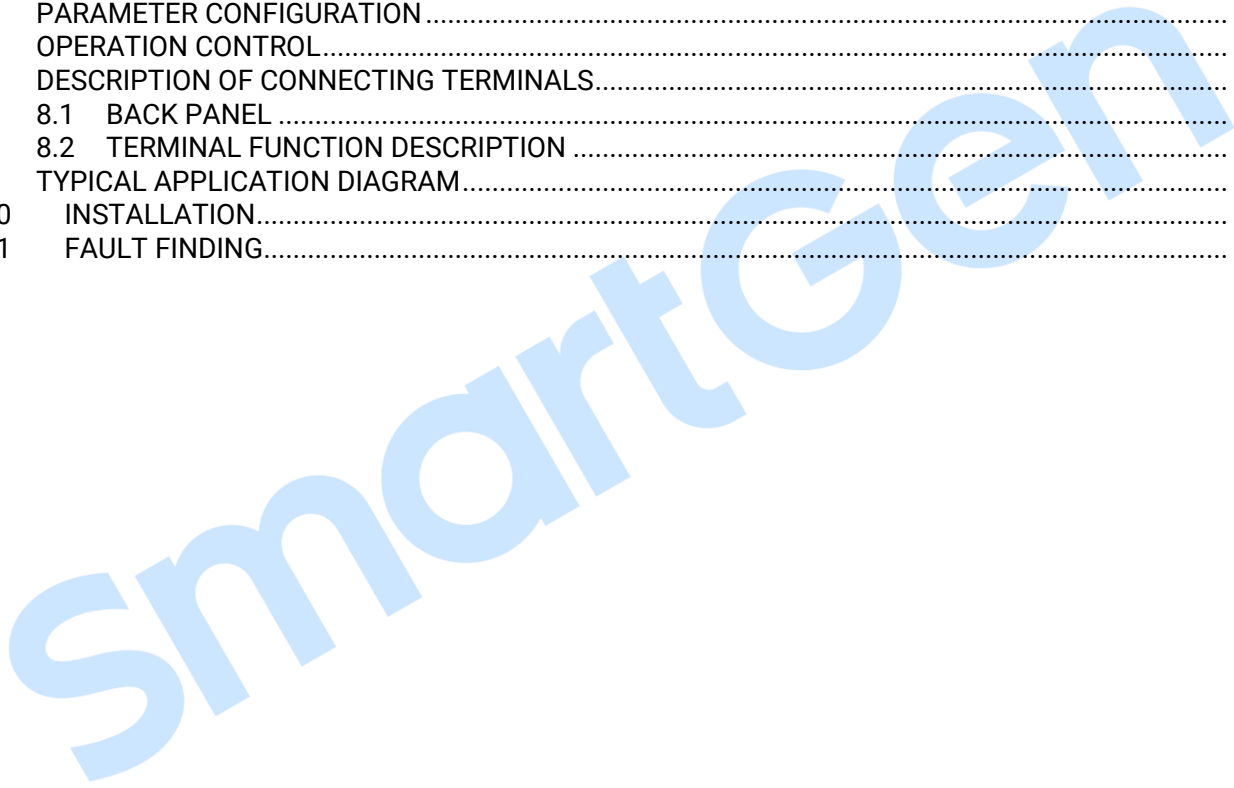

1 OVERVIEW

HAT520N Dual Power ATS Controller is made by the core of the microprocessor, which can precisely detect 2-way 3-phase voltages, 2-way single phase voltages and make accurate judgment for the occurred abnormal voltages (lost of power, over voltage, under voltage, over frequency, under frequency, loss of phase, reverse phase sequence), controlling ATS switchover after delay. It is suitable for controlling No Breaking ATS, and it has the function of issuing genset start signal after abnormal delay of one way. By LINK communication port, "Three Remote" (remote measurement, remote communication and remote control) function can be realized.

2 PERFORMANCE AND CHARACTERISTICS

It has the following characteristics:

- Measure and display 2-way 3-phase voltage and frequency:

1#	2#
Line voltage (Uab, Ubc, Uca)	Line voltage (Uab, Ubc, Uca)
Phase voltage (Ua, Ub, Uc)	Phase voltage (Ua, Ub, Uc)
Frequency Hz	Frequency Hz

- Over/under voltage, loss of phase, reverse phase sequence, over/under frequency protection function. As default, reverse phase sequence protection and over/under frequency protection are disabled; however, users can set the protection function as you need.
- LINK communication port (SmartGen SG72 adapter is needed), with which controller parameters can be set and firmware update also can be realized.
- The voltage normal delay of 1# or 2# can be set (Range: 0s~60s) and Genset start delay can be set (Range: 0s~3600s).
- The voltage abnormal delay of 1# or 2# can be set (Range: 0s~60s) and Genset stop delay can be set (Range: 0s~3600s).
- "1# Master", "Mutual Backup" and "2# Master" can be set via controller front panel, so that 1# power master supply, or 2# power master supply, or mutual backup power supply for each other can be realized.
- Close output signal can be set as pulse or continuous output.
- 2-way N-wire isolated design.
- Auto/Manual mode transfer. In manual mode, ATS transfer 1# switch or 2# switch can be implemented via panel pushbutton.
- LEDs mounted on front panel can clearly show ATS running status.
- The output contactor capacity of 1# and 2# power transfer relay (1# CLOSE, 2# CLOSE) is 16A AC250V, volts-free contact, which can be directly used in driving switch to transfer.
- The output contactor capacity of Genset start relay (GENS START) is 7A AC250V/7A DC28V, volts-free N/C contact.
- Suitable for various AC systems (3-phase 4-wire, 2-phase 3-wire and single-phase 2-wire).
- Modular design, flame retardant ABS plastic shell, pluggable terminal, built-in mounting, compact structure with easy installation.

3 SPECIFICATION

Table 2 Technical Parameters

Items	Contents
Operating Voltage	AC170V~277V during AC power L1N1/L2N2 supply.
Power Consumption	<2W (Standby mode: <1W)
AC Voltage Input	
3P4W (ph-N)	AC170V~AC277V(ph-N)
1P2W (ph-N)	AC170V~AC277V (ph-N)
2P3W (ph-N)	AC170V~AC277V(ph-N)
Rated Frequency	50/60Hz
1# Close Relay Output	16A AC250V Volts free output
2# Close Relay Output	16A AC250V Volts free output
Gen Start Relay	7A AC250V Volts free output
1# Close Input	COM connect is active.
2# Close Input	COM connect is active.
Communication	LINK interface, MODBUS Protocol
Case Dimensions	139mmx120mmx50mm
Panel Cutout	130mmx111mm
Working Temperature	(-25~+70)°C
Working Humidity	(20~93)%RH
Storage Temperature	(-30~+80)°C
Protection Level	IP55 Gasket: when waterproof gasket is installed between controller and control window.
Insulation Strength	Apply AC1.5kV voltage between high voltage terminal and low voltage terminal and the leakage current is not more than 3mA within 1min.
Weight	0.49kg

4 PANEL DESCRIPTION

4.1 PANEL OPERATION

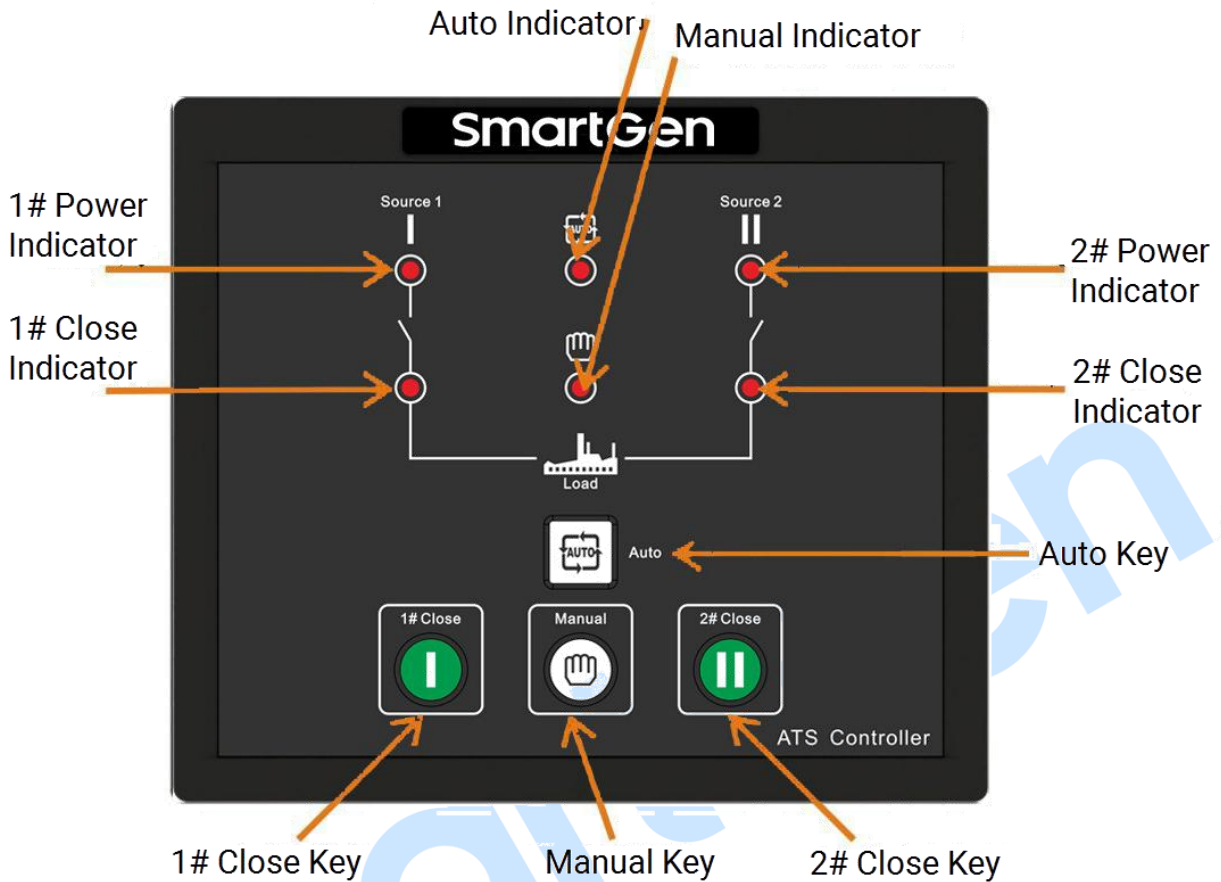

Fig.1 Panel Description

4.2 INDICATOR LIGHT FUNCTION DESCRIPTION





Table 3 Indicator Function Description Under Normal Test Mode

Item	Function Description
1# Power Indicator	It is illuminated when 1# power is normal; flashing when 1# power state is abnormal; off when there is no 1# power.
2# Power Indicator	It is illuminated when 2# power is normal; flashing when 2# power state is abnormal; off when there is no 2# power.
1# Close Indicator	It is illuminated when 1# power auxiliary contactor is active while off when it is deactivated.
2# Close Indicator	It is illuminated when 2# power auxiliary contactor is active while off when it is deactivated.
Auto Indicator	It is illuminated when the controller is in auto mode while off the controller is in manual mode.
Manual Indicator	It is illuminated when the controller is in manual mode while off the controller is in auto mode.

NOTE: For indicator description under parameter setting mode, please refer to following "Panel Operation Setting".





5 PANEL OPERATION SETTING

5.1 PANEL OPERATION

Pressing and holding the  button for more than 3s, all LEDs are illuminated to enter into lamp test mode; Keep holding  and do not release, after 7s all LEDs are flashing (once per 500ms) to enter into parameter setting status and release ; If you are not trying to set parameters, press  and all LEDs flash quickly for 5 times (once per 200ms) to return to normal test mode. Under lamp test status, release  and controller returns back to normal test mode. After entering parameter setting, if you are not setting, controller will automatically return back to normal test mode after about 1 minute and 30 seconds.

5.2 MASTER SETTING

First of all, make controller enter parameter setting state, and then conduct the settings. Procedures of setting "1# Master", "2# Master", and "Mutual Backup" power supply:







- a) Press ,  and  at the same time, when 1#/2# power indicator and auto indicator are illuminated; release the three buttons, then the auto indicator and 2# power indicators extinguish, 1# power indicator illuminates, which means controller master setting is entered.
- b) Pressing  can circularly set 3 conditions of power supply.
 - 1# Master:** 1# power indicator illuminates and 2# power indicator extinguishes;
 - 2# Master:** 2# power indicator illuminates and 1# power indicator extinguishes;
 - Mutual Backup:** 1# power and 2#power indicators are illuminating at the same time;
- c) After adjusting, press , when 1# power indicator, auto indicator and 2# power indicator are illuminating, the adjusted master power supply has been saved. The controller will back to normal status automatically after all LEDs are flashing for 5 times rapidly. Controller will work according to the master setting.

▲NOTE: Once the controller is power on, master status can be judged by the following three conditions.

- If 1# power supply indicator flashes rapidly for three times, it indicates 1# power supply is master.
- If 2# power supply indicator flashes rapidly for three times, it indicates 2# power supply is master.
- If 1# and 2# power supply indicators flash simultaneously for three times, it indicates it is mutual backup state.

5.3 AC SYSTEM SETTING

First of all, make controller enter parameter setting status and then conduct the settings. Procedures of setting “Single-phase 2-wire”, “3-phase 4-wire” and “2-phase 3-wire”:

- a) Press ,  and  at the same time, when 1#/2# power indicator and auto indicator are illuminated, release the three buttons, then the auto indicator and 2# power indicators extinguish, 1# power indicator illuminates.
- b) Press , when 1#/2# power indicator and auto indicator are illuminated, release the button, then the auto indicator and 1#/2# power indicators are extinguished simultaneously, which means controller AC system can be set.
- c) Pressing  can circularly set three AC systems.
Single-phase 2-wire: 1# close indicator illuminates;
3-phase 4-wire: 1# close indicator, 2# close indicator and manual mode indicator illuminates simultaneously;
2-phase 3-wire: 1# close indicator and manual mode indicator illuminates simultaneously.
- d) After adjusting, press , when 1# power indicator, auto indicator and 2# power indicator are illuminating, the adjusted AC system setting has been saved. The controller will back to normal status automatically after all LEDs are flashing 5 times rapidly. Controller will work according to the set AC system.

▲NOTE: Once the controller is power on, its AC system can be judged by the following three conditions.

- If 1# close indicator illuminates it means Single-phase 2-wire system is selected.
- If 1# close indicator, manual mode indicator and 2# close indicator illuminate simultaneously it means 3-phase 4-wire system is selected.
- If 1# close indicator and manual mode indicator illuminate simultaneously it means 2-phase 3-wire system is selected.



5.4 DELAY ADJUSTMENT

Adjusting “1# power normal delay” potentiometer (located nearby the back panel terminal) can set output delay after 1# power supply is normal.

Adjusting “2# power normal delay” potentiometer (located nearby the back panel terminal) can set output delay after 2# power supply is normal.

First of all, make controller enter parameter setting status, and then conduct the setting.



Setting Procedures of “1# power abnormal delay” and “2# power abnormal delay”:

- a) Press  and  at the same time, when 1#/2# power indicator and auto indicator are illuminated, release the two buttons, then the auto indicator and 1#/2# power indicators are extinguished simultaneously, which means the delay timer of the controller can be set.
1# power abnormal delay: adjust “1# Power Normal Delay” potentiometer;
2#power abnormal delay: adjust “2#Power Normal Delay” potentiometer.
- b) After adjusting the delays, press , when 1#/2# power indicator and automatic indicator are illuminated simultaneously, the adjusted value has been saved. The controller will back to normal status automatically after all LEDs are flashing 5 times rapidly. Controller will work according to the set delay values.

NOTE: 1# Normal Delay set value must be no less than 1# Abnormal Delay, otherwise, 1# Normal Delay set value will be forced to set as 1# Abnormal Delay set value. 2# Normal Delay set value must be no less than 2# Abnormal Delay, otherwise, 2# Normal Delay set value will be forced to set as 2# Abnormal Delay set value.

5.5 RESTORE FACTORY DEFAULT

First of all, make controller enter parameter setting status and then conduct the setting.





- a) Press  and  at the same time, when 1#/2# power indicator and auto indicator are illuminated, release the two buttons, then the auto indicator and 1#/2# power indicators are extinguished simultaneously, which means the default delay value of the controller can be set.
- b) Press , when 1#/2# power indicator and auto indicator are illuminated simultaneously, the factory default has been restored. The controller will back to normal status automatically after all LEDs are flashing 5 times rapidly. Controller will work according to the set delay values.

NOTE: By default, 1# and 2# abnormal delay is 5s and genset stop delay is 90s.

5.6 AUTO TRANS. AUTO RESTORE SETTING

First of all, make controller enter parameter setting status and then conduct the setting.

Set "Auto Trans. Auto Restore", "Auto Trans. Non-Restore" steps:

- a) Press  and  at the same time, when 1#/2# power indicators and auto indicator are illuminated, release the two buttons, then the auto indicator and 2# power indicator are extinguished, 1# power indicator and 1# close indicator are illuminated, which means the auto trans. auto restore of the controller can be set.
- b) Press  can circularly set two states:
Auto trans. non-restore when 1# power indicator and 1# close indicator are illuminated, 2# power indicator and 2# close indicator are extinguished.
Auto trans. auto restore when 2# power indicator and 2# close indicator are illuminated, 1# power indicator and 1# close indicator are extinguished.
- c) After adjustment, press . When the 1#/2# power indicators and auto indicator are illuminated at the same time, it indicates that the set parameter value has been saved successfully; all indicators on the panel flash 5 times quickly to return to normal test mode. The controller works according to the set state of auto trans. auto-restore/auto trans. non-restore.

▲NOTE: Turn on the power supply of the controller, auto trans. auto-restore/auto trans. non-restore set by the controller can be judged by the following two situations:

If 1# power indicator and 1# close indicator flash quickly three times at the same time, it is auto trans. non-restore.

If 2# power indicator and 2# close indicator flash quickly three times at the same time, it is auto trans. auto restore.

6 PARAMETER CONFIGURATION

Table 4 Parameter Configuration

No.	Item	Range	Default	Description
01	1# Normal Delay	(0-60)s	Can be set via controller potentiometer	It is the delay of 1# power from voltage abnormal to voltage normal. Generally, it is 10s.
02	1# Abnormal Delay	(0-60)s	5	It is the delay of 1# power from voltage normal to voltage abnormal.
03	2# Normal Delay	(0-60)s	Can be set via controller potentiometer	It is the delay of 2# power from voltage abnormal to voltage normal. Generally, it is 10s.
04	2# Abnormal Delay	(0-60)s	5	It is the delay of 2# power from voltage normal to voltage abnormal.
05	Close Delay	(0-20)s	5	Closing relay output pulse. If set as zero, it is continuous output.
06	Exceed Transfer	(0-20.0)s	0.0	It is the continuous output delay of the close relay after the closing signal has received.
07	Start Delay	(0-3600)s	1	When voltage is abnormal, start delay begins; start signal is initiated after the delay has expired.
08	Stop Delay	(0-3600)s	90	When starting, if the voltage is normal, stop delay begins; stop signal is initiated after the delay has expired.
09	AC System	(0-2)	0	0. 3-phase 4 wires 1. 2-phase 3 wires 2. Single phase 2 wire
10	Rated Volt	(100-240)V	230	AC system rated voltage.
11	Rated Frequency	(50.0-60.0)Hz	50.0	To offer standards for detecting of over/under frequency.
12	Over Volt Enable	(0-1)	1	0: Disable; 1: Enable
13	Over Voltage	(100-120%)	115	Voltage upper limit; it is abnormal when the voltage has exceed the set value.
14	Over Voltage Return	(100-120%)	113	Voltage upper limit return value; it is normal only when the voltage fallen below the set value.
15	Under voltage	(70-100%)	75	Voltage lower limit; it is abnormal when the voltage has fallen below the set value.
16	Under Voltage Return	(70-100%)	77	Voltage lower limit return value; it is normal only when the voltage has exceeded the set value.
17	Over Freq Enable	(0-1)	0	0: Disable; 1: Enable
18	Over Frequency	(100-120%)	110	Frequency upper limit; it is abnormal when the frequency has exceed the set value.

No.	Item	Range	Default	Description
19	Over Frequency Return	(100-120%)	104	Frequency upper limit return value; it is normal only when the frequency fallen below the set value.
20	Under Freq Enable	(0-1)	0	0: Disable; 1: Enable
21	Under Frequency	(80-100%)	90	Frequency lower limit; it is abnormal when the frequency has fallen below the set value.
22	Under Frequency Return	(80-100%)	96	Frequency lower limit return value; it is normal only when the frequency has exceeded the set value.
23	Loss of Phase	(0-1)	1	0: Disable; 1: Enable
24	Phase Sequence Wrong	(0-1)	0	0: Disable; 1: Enable
25	Master-Slave Set	(0-2)	0	0. 1# Master; 1. 2# Master; 2. Mutual Backup.
26	Auto Trans. Auto Restore Set	(0-1)	1	0: Auto Trans. Non-Restore; 1: Auto Trans. Auto Restore.



NOTE1: Parameters above are configured by SmartGen PC software. PC program connection: LINK interface of SG72 connects with the interface of controller.

NOTE2: "1# Normal Delay" and "2# Normal Delay" can be set only via the potentiometer which locates nearby the back panel terminal. "1# Abnormal Delay" and "2# Abnormal Delay" can be set via the PC software or potentiometer which locates nearby the back panel terminal. AC system and master-slave set can be set via panel button or PC software. And other parameters can be set via PC software only.



NOTE3: 1# Normal Delay set value must be no less than 1# Abnormal Delay, otherwise, 1# Normal Delay set value will be forced to set as 1# Abnormal Delay set value. 2# Normal Delay set value must be no less than 2# Abnormal Delay, otherwise, 2# Normal Delay set value will be forced to set as 2# Abnormal Delay set value. If motor driving type ATS (e.g. SOCOMEC VS) is applied, the Close delay and Open delay must be no less than 5s; If magnet driving type ATS (e.g. SGQ-N) is applied, the Exceed Transfer delay must be set as 0.

NOTE4: "Priority Select" in last version is changed to "Master-Slave Set"; Set contents "0: 1# Priority; 1: 2# Priority; 2: No Priority" are changed to "0: 1# Master; 1: 2# Master; 2: Mutual backup".

7 OPERATION CONTROL

When controller is running, press  and auto indicator is illuminated, controller switches to auto status; Press , manual status indicator is illuminated, and controller switches to manual status.

In Auto mode, controller can automatically transfer load to 1# power or 2# power; when Auto Trans, Auto Restore is set, master power is normal, and controller will transfer to master power in priority; When Auto Trans. Non Restore is set, controller will only transfer to backup power, and master power can only be controlled manually. Each Backup is for two powers to be backup; When 1# power is abnormal, and 2# power is normal, switch will transfer to 2# power supply, and vice versa. When it is set to Each Backup, controller will not detect Auto Trans. Auto Restore setting.

In Manual mode, press  key, load will be transferred to 1# power supply; press  key, load will be transferred to 2# power supply.

8 DESCRIPTION OF CONNECTING TERMINALS

8.1 BACK PANEL

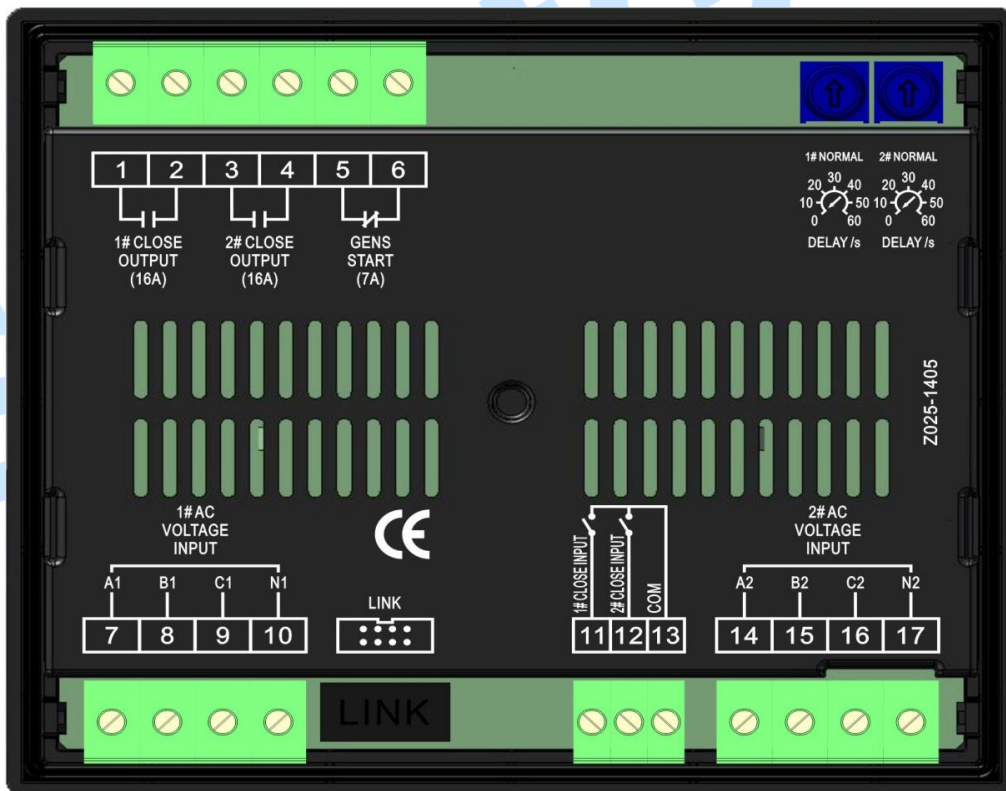

Fig.2 HAT520N Back Panel

8.2 TERMINAL FUNCTION DESCRIPTION

Table 5 Terminal Description

No.	Items	Description	Remark
1	1# Close Output	Volt-free relay contact output	N/O contact output; rated 16A.
2			
3	2# Close Output	Volt-free relay contact output	N/O contact output; rated 16A.
4			
5	Gens Start	Volt-free relay contact output	N/O contact output; rated 7A.
6			
7	A1	1# AC 3-phase 4 wire voltage input	For single phase, only connect A1, N1.
8	B1		
9	C1		
10	N1		
11	1# Close Input	Detection of 1# ATS closing status; auxiliary contact input	Connect COM is active.
12	2# Close Input	Detection of 2# ATS closing status; auxiliary contact input	Connect COM is active.
13	COM	COM	
14	A2	2# AC 3-phase 4 wire voltage input	For single phase, only connect A2, N2.
15	B2		
16	C2		
17	N2		
LINK	Communication Port	Communicate with PC/Program update	

9 TYPICAL APPLICATION DIAGRAM

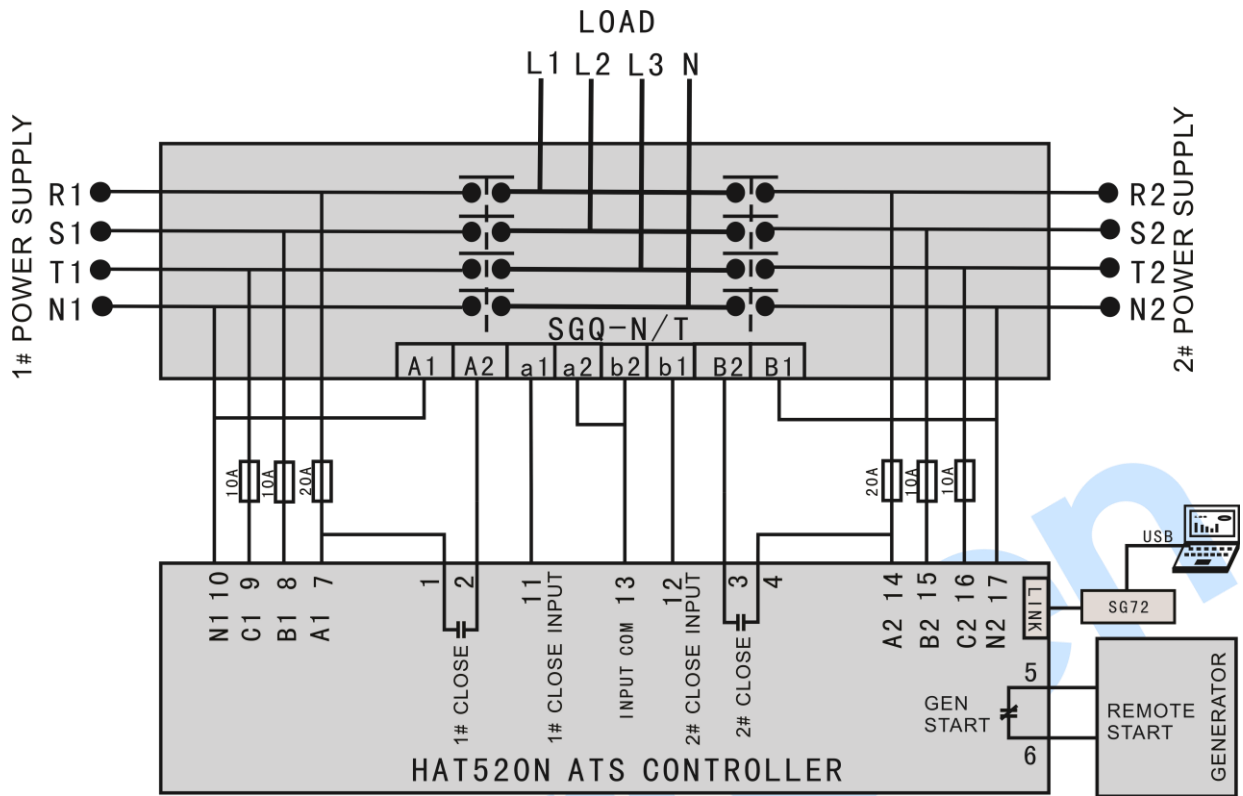

Fig.3 SGQ-N/T Application Diagram

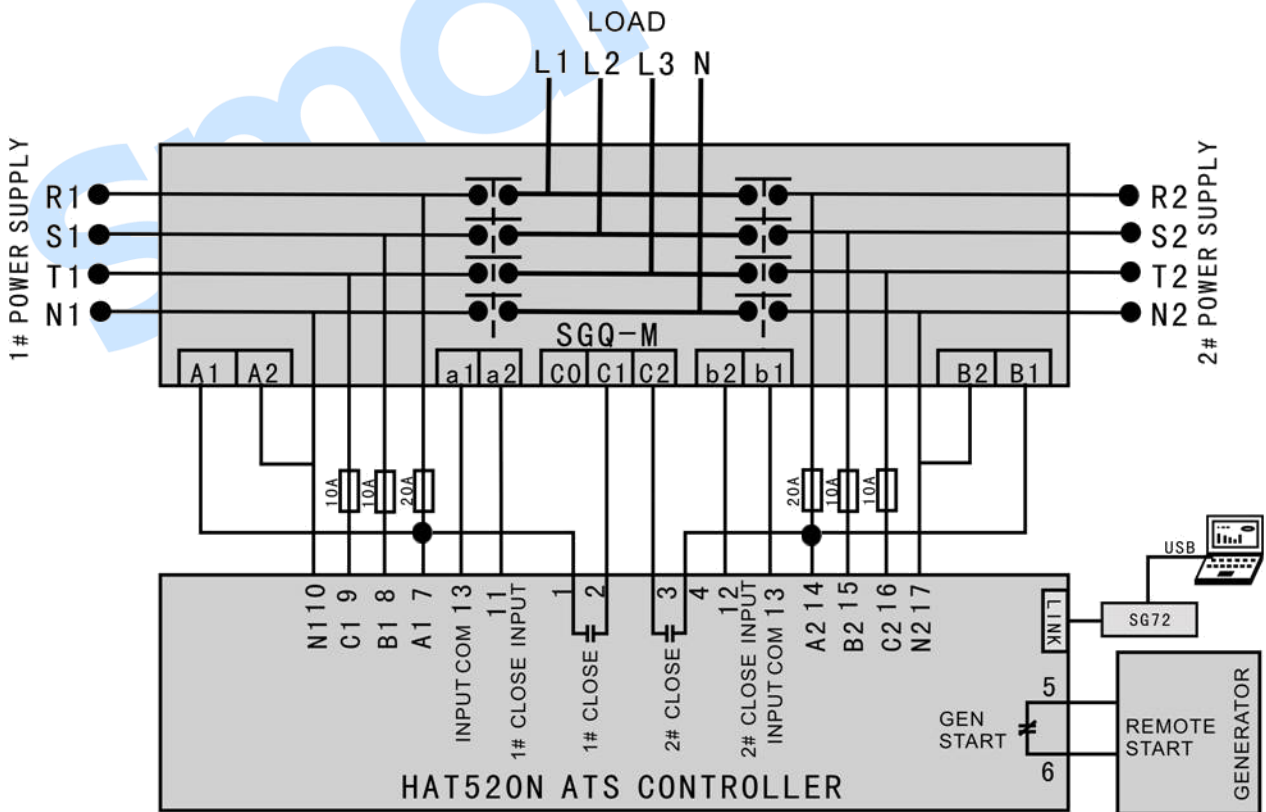

Fig.4 SGQ-M Application Diagram

NOTE: The diagram is for reference only. The actual wiring shall follow the ATS instruction. Users should choose proper fuse capacity according to the actual power consumption.

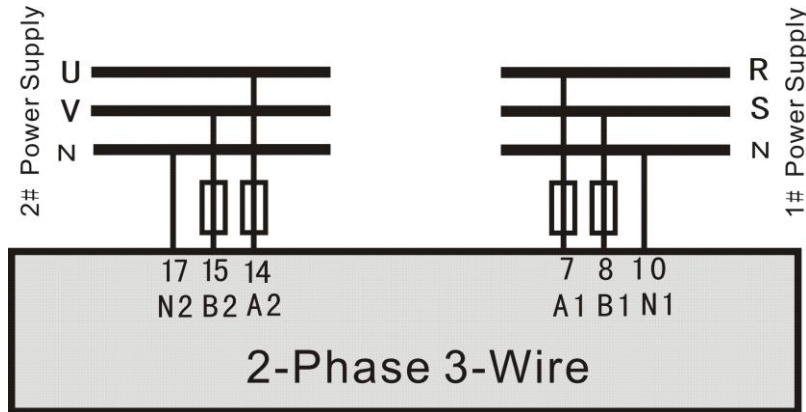

Fig.5 2-phase 3-wire Wiring Diagram

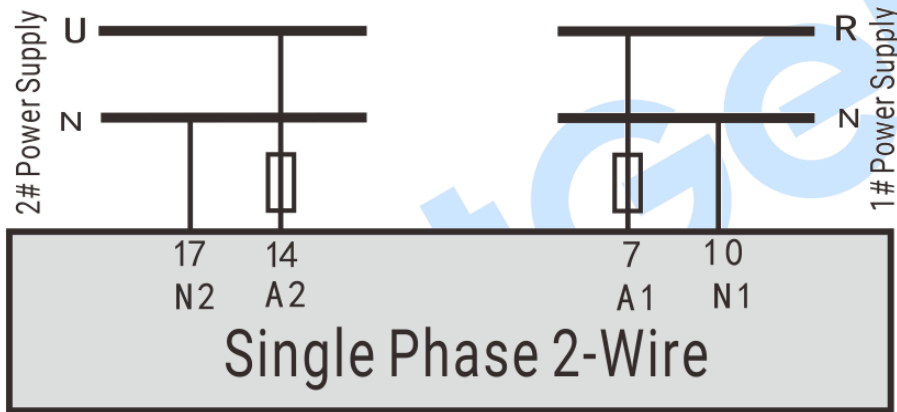

Fig.6 Single phase 2-wire Wiring Diagram

NOTE: Above pictures take the AC 220V voltage as example. If AC 110V voltage is applied in actual use, please contact with SmartGen technical staff to get the specific wiring methods.

10 INSTALLATION

Unit: mm

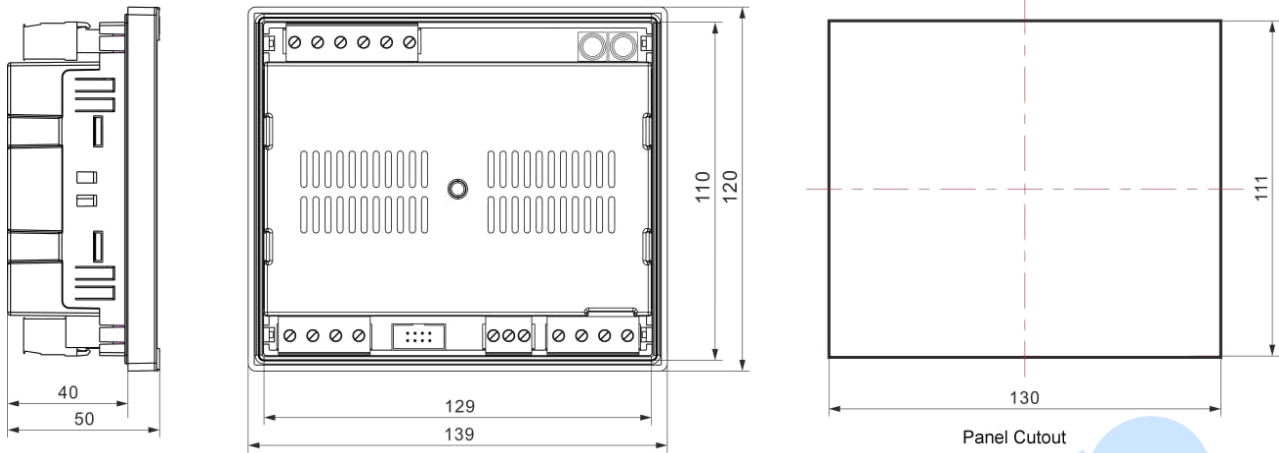

Fig.7 Installation Dimension

11 FAULT FINDING

Table 6 Common Faults

Symptom	Possible Solutions
Controller no response with power	Check starting batteries.
ATS not transfer	Check ATS; Check the connection wirings between the controller and the ATS.
Electrical parameters detection error	Check controller wiring; Modify electrical parameters detection value
PC software communication failure	Check communication port setting and connections.