

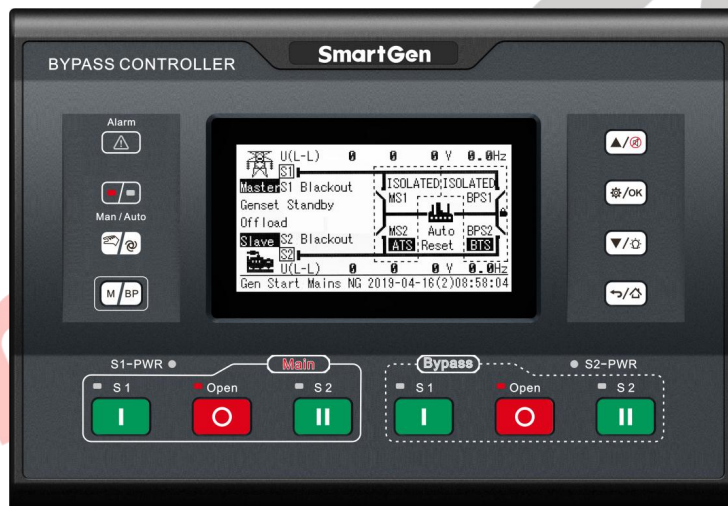

**SmartGen**  
ideas for power

**HAT880 SERIES**  
**(HAT880/HAT880S)**  
**DUAL POWER BYPASS ATS CONTROLLER**  
**USER MANUAL**



**SMARTGEN (ZHENGZHOU) TECHNOLOGY CO., LTD.**



Chinese trademark

**SmartGen** English trademark

SmartGen – make your generator *smart*

SmartGen Technology Co., Ltd.

No.28 Jinsuo Road, Zhengzhou, Henan Province, China

Tel: +86-371-67988888/67981888/67992951

+86-371-67981000(overseas)

Fax: +86-371-67992952

Email: [sales@smartgen.cn](mailto:sales@smartgen.cn)

Web: [www.smartgen.com.cn](http://www.smartgen.com.cn)

[www.smartgen.cn](http://www.smartgen.cn)

All rights reserved. No part of this publication may be reproduced in any material form (including photocopying or storing in any medium by electronic means or other) without the written permission of the copyright holder.

Applications for the copyright holder's written permission to reproduce any part of this publication should be addressed to SmartGen Technology at the address above.

Any reference to trademarked product names used within this publication is owned by their respective companies.

SmartGen Technology reserves the right to change the contents of this document without prior notice.

**Table 1 - Software Version**

Date	Version	Note
2019-04-25	1.0	Original release.
2019-07-12	1.1	Add Synchronous switchover function description.
2021-04-07	1.2	Modify the front panel drawing, back panel drawing, overall dimension & panel cutout drawing of the controller; Upgrade the translation, font and format of the manual.

# CONTENT

1 OVERVIEW .....	4
2 NAME CONVENTION AND MODEL CONTRAST .....	4
2.1 NAME CONVENTION.....	4
2.2 MODEL CONTRAST .....	4
3 PERFORMANCE AND CHARACTERISTICS .....	5
4 SPECIFICATION.....	6
5 MEASURE AND DISPLAY DATA .....	7
6 OPERATION .....	8
6.1 INDICATORS .....	8
6.2 KEY FUNCTION DESCRIPTION .....	9
7 LCD DISPLAY .....	10
7.1 MAIN SCREEN .....	10
7.2 STATUS DESCRIPTION .....	11
7.3 MAIN MENU.....	16
8 START/STOP OPERATION.....	17
8.1 MANUAL START/STOP.....	17
8.2 AUTO START/STOP .....	18
9 PARAMETERS CONFIGURATION .....	20
9.1 ILLUSTRATION .....	20
9.2 PARAMETER CONFIGURATION TABLE .....	20
9.3 DIGITAL INPUT/OUTPUT FUNCTION DESCRIPTION .....	30
9.4 DEFINITE TIME AND INVERSE DEFINITE TIME OF OVER CURRENT .....	35
10 HISTORICAL RECORDS.....	36
11 BLACK BOX RECORDS.....	38
12 SWITCH OPERATION .....	39
12.1 MANUAL OPERATION.....	39
12.2 AUTOMATIC OPERATION.....	39
12.3 SYNCHRONING CLOSE.....	39
13 ATS POWER SUPPLY .....	42
14 NEL CONTROL.....	43
14.1 ILLUSTRATION .....	43
14.2 AUTO OPERATION .....	43
14.3 MANUAL OPERATION.....	43
15 COMMUNICATION CONFIGURATION .....	44
16 TERMINALS .....	44
17 TYPICAL WIRING DIAGRAM .....	47
18 INSTALLATION.....	48
19 TROUBLE SHOOTING.....	49

## 1 OVERVIEW

**HAT880 Series Dual Power Bypass ATS Controller** is an intelligent dual power bypass switch module which integrates programmable function with automatic measurement, LCD display and digital communication. It is with qualities of digitalization, intelligence, and network. Measurement and control automation is realized for reducing human operation mistakes, so it is the ideal device for dual power bypass switch.

**HAT880 Series Dual Power Bypass ATS Controller** is composed of micro-processor, which is the core in the controller, and can precisely detect 2-way 3-phase power, making correct judgment for abnormal power statuses (over voltage, under voltage, loss of phase, over frequency, under frequency) and outputting free voltage control signals. After overall consideration about its bypass switch application, it can be used directly on single and dual bypass switches, and manual or remote control switches. It is with compact structure, advanced circuit, simple wiring, and high reliability, and can be widely used in electrics, telecommunications, petroleum, coal, metallurgy, railway, municipal administration, intelligent building fields, electric installations, servicer power supply and debug system.

## 2 NAME CONVENTION AND MODEL CONTRAST

### 2.1 NAME CONVENTION

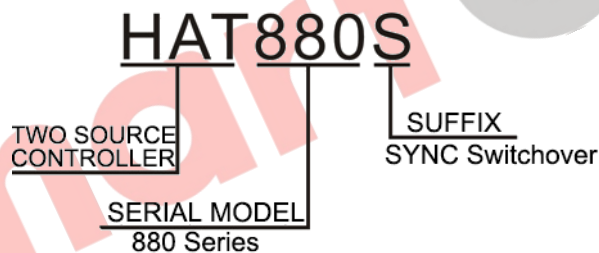

Fig. 1 - Name Convention Diagram

### 2.2 MODEL CONTRAST

Table 2 - Model

FUNCTION							
Model	DC Supply	AC Supply	AC Current and Power	SYNC Close	Input No. (Fixed. + Flex.)	Output No. (Flex.)	RS485
HAT880	•	• (90~305)V	•		12	12	•
HAT880S	•	• (90~305V)	•	•	12	12	•



### 3 PERFORMANCE AND CHARACTERISTICS

- System type can set as: S1 Mains S2 Mains, S1 Mains S2 Gen, S1 Gen S2 Mains, S1 Gen S2 Gen;
- 4.3 inchs solid color 240x128 pixel LCD display with white backlit, multilingual interface (including English, Simplified Chinese and other languages), push-button operation;
- Collect and display voltage, frequency and phase sequence of 2-way 3-phase;
- Collect and display active power, reactive power, apparent power, power factor and current of load;
- Display position of main switch (working, testing, insulated), and position of bypass switch (working, testing, insulated);
- Independent S1/S2 over current warning or trip alarm functions;
- NEL (Non-essential Load) trip function;
- Display S1/S2 total kW energy, total kvar energy;
- Display S1/S2 accumulated close times of main switch and bypass switch;
- Display continuous power supply time at present and last time, and S1/S2 total power supply time;
- Can realize synchronous switchover function, and display voltage difference, frequency difference and phase difference of 2 circuits;
- For energy-accumulated ATS, it shall close when switch PF(close is prepared well) signal is active;
- Over/under voltage, over/under frequency, over current, loss of phase, inverse phase sequence protection functions;
- Automatic/Manual mode switchover; In manual mode, close or open can be controlled manually;
- All parameters can be set on site. Password validation is applied to prevent wrong operations for non-professionals;
- The genset can be tested manually on site to achieve start/stop operation;
- Re-close function of main switch and bypass switch in auto mode when power outage occurs;
- Applicable for single bypass, double bypass and alternate dual spare bypass switch;
- Applicable for bypass switch of manual control and remote control
- 2-way N wire isolated design;
- Real-time clock (RTC); event log function, which can record 200 items circularly;
- Black box record function, which can record 5 events circularly, 60 data of 50s before each event record, and 10s after each event record;
- Scheduled routing start & scheduled not start function for the genset, which can be set as start once a day/week/month; and running with load or not;
- Can control two generators to work in the mode of circular running, master running and balanced running;
- Wide DC power supply range, which allows the controller to bear instantaneous 80V DC current input;
- Large terminal space allows the controller to bear maximum 625V AC voltage input;
- Dual isolated RS485 communication interface, having the functions of "remote control, remote measuring, remote communication, remote regulating" by the ModBus-RTU

- communication protocol, which can remotely start/stop the genset and control the breaker to close or open;
- Suitable for multiples of AC systems (3-phase 4-wire, 3-phase 3-wire, single-phase 2-wire, and 2-phase 3-wire);
  - Modular design, antifraining ABS plastic shell, pluggable terminals, built-in mounting, compact structure and easy installation.

#### 4 SPECIFICATION

**Table 3 - Performance Parameters**

Items	Contents	
Operating Voltage	1. DC8.0V~35.0V, continuous power supply 2. AC(90~305)V power supply A1N1/A2N2	
Power Consumption	<7W(Standby mode:≤2W)	
AC Voltage Input	AC system	
	3P4W (L-L)	(80~530)V
	3P3W (L-L)	(80~625)V DC supply
	1P2W (L-N)	(50~305)V
	2P3W (A-B)	(80~530)V
Rated Frequency	50/60Hz	
Programmable Output 1~6 Relay Capacity	16A AC250V Volts free output	
Programmable Output 7~12 Relay Capacity	8A AC250V Volts free output	
Digital Input	GND (B-) connected is active.	
Communication	1. Dual-RS485 isolated interface, MODBUS Protocol 2. Form D USB port	
Case Dimensions	260mmx180mmx54mm	
Panel Cutout	242mmx161mm	
Working Conditions	Temperature: (-25~+70)°C; Relative Humidity: (20~95)%RH	
Storage Condition	Temperature: (-30~+80)°C	
Protection Level	IP65: when water proof gasket ring inserted between screen and housing.	
Insulation Strength	Apply AC1.5kV voltage between high voltage terminal and low voltage terminal, and the leakage current is not more than 3mA within 1min.	
Weight	1.2kg	

## 5 MEASURE AND DISPLAY DATA

**Table 4 - Display Parameters**

No.	Measure & Display Data Items
1	S1/S2 Power Phase Voltage
2	S1/S2 Power Line Voltage
3	S1/S2 Power Voltage Phase
4	S1/S2 Power Frequency
5	Load 3-Phase Current
6	Load 3-Phase Active Power kW
7	Load Total Active Power kW
8	Load 3-Phase Reactive Power kvar
9	Load Total Reactive Power kvar
10	Load 3-Phase Apparent Power kVA
11	Load Total Apparent Power kVA
12	Load 3-Phase Power Factor PF
13	Load Average Power Factor PF
14	Continuous Power Supply Time (Currently)
15	Continuous Power Supply Time (Last Time)
16	S1 Total Power Supply Time
17	S2 Total Power Supply Time
18	S1 Total kW Energy kWh
19	S2 Total kW Energy kWh
20	S1 Total kvar Energy kvarh
21	S2 Total kvar Energy kvarh
22	MS1 Total Close Times
23	MS2 Total Close Times
24	BPS1 Total Close Times
25	BPS2 Total Close Times
26	Digital Input/Output Port Status
27	Real Time Clock
28	Historical Records
29	Black Box Records
30	Communication Status
31	Sync. information (HAT880S)

## 6 OPERATION

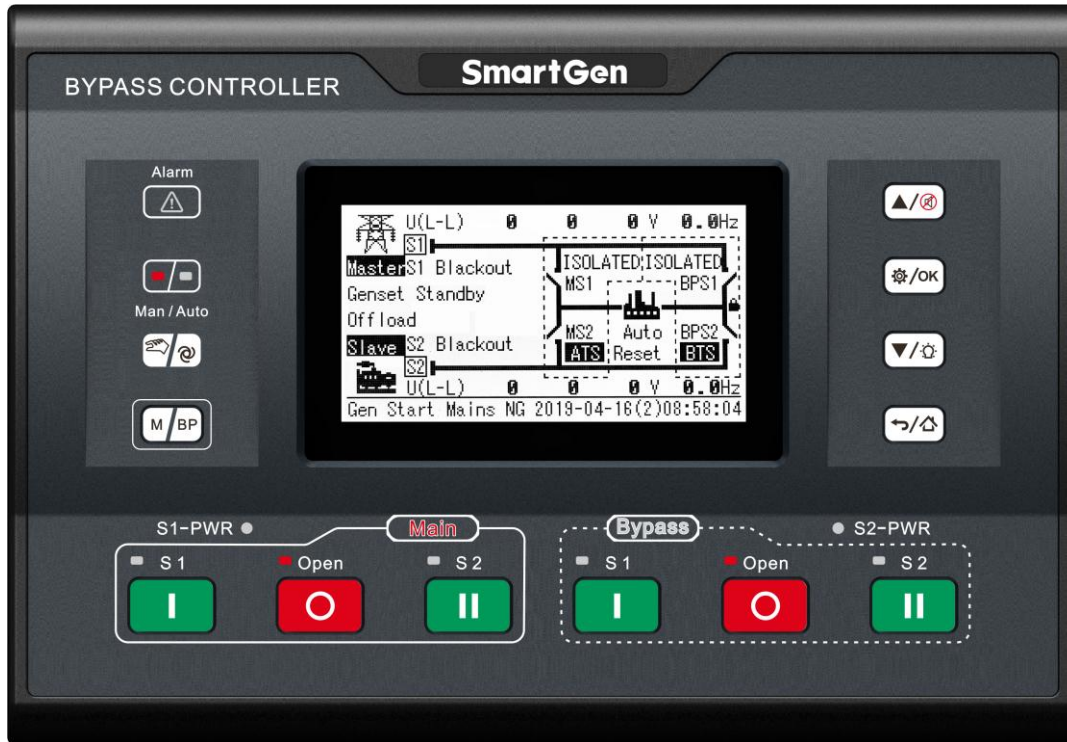

Fig. 2 - Panel Indication Diagram

### 6.1 INDICATORS













Table 5 - Indicators Description

Indicator Type	Description
Alarm	Slow flashing (1 time per sec) when warning alarm occurs. Fast flashing (5 times per sec) when fault alarm occurs.
Man	Light on when the module is in Manual mode.
Auto	Light on when the module is in Auto mode.
S1-PWR	S1 power indicator: always illuminated when S1 is normal; slow flashing (1 time per sec) when voltage is abnormal; extinguished when S1 is no power.
S2-PWR	S2 power indicator: always illuminated when S2 is normal; slow flashing (1 time per sec) when voltage is abnormal; extinguished when S2 is no power.
Main	When main switch is unlocked, main indicator is always illuminated.
Bypass	When bypass switch is unlocked, bypass indicator is always illuminated.
Main S1	Always illuminated: Main S1 closes, load is supplied by S1.
Main Open	Always illuminated: Main is open.
Main S2	Always illuminated: Main S2 closes, load is supplied by S2.
Bypass S1	Always illuminated: Bypass S1 closes, load is supplied by S1.
Bypass Open	Always illuminated: Bypass is open.
Bypass S2	Always illuminated: Bypass S2 closes, load is supplied by S2.



## 6.2 KEY FUNCTION DESCRIPTION





**Table 6 – Buttons Function Description**

Icon	Buttons	Function Description
	Main Close S1	Active when bypass is locked (main is unlocked) in manual mode; Press and if main S1 has opened, main S1 close outputs; When Sync close is active, if main S2 has closed, press and main S1 sync close outputs; when main S1 is waiting for Sync, press again and it shall stop main S1 Sync close.
	Main Open	Active when bypass is locked (main is unlocked) in manual mode; Press and main switch shall open.
	Main Close S2	Active when bypass is locked (main is unlocked) in manual mode; Press and if main S2 has opened, main S2 close outputs; When Sync close is active, if main S1 has closed, press and main S2 sync close outputs; when main S2 is waiting for Sync, press again and it shall stop main S2 Sync close.
	Bypass Close S1	Active when main is locked (bypass is unlocked) in manual mode; Press and if bypass S1 has opened, bypass S1 close outputs; When Sync close is active, if bypass S2 has closed, press and bypass S1 sync close outputs; when bypass S1 is waiting for Sync, press again and it shall stop bypass S1 Sync close.
	Bypass Open	Active when main is locked (bypass is unlocked) in manual mode; Press and bypass switch shall open.
	Bypass Close S2	Active when main is locked (bypass is unlocked) in manual mode; Press and if bypass S2 has opened, bypass S2 close outputs; When Sync close is active, if bypass S1 has closed, press and bypass S2 sync close outputs; when bypass S2 is waiting for Sync, press again and it shall stop bypass S2 Sync close.
	Manual/ Auto	Manual mode and Auto mode switchover.
	Main/ Bypass	Main switch and bypass switch switchover.
	Return/ Homepage	When parameters are being set, press it and the page shall return back. In main screen, press the key to return the first screen; in other screen, press the key to return to main screen.
	Set/Confirm	In main screen, press the key to enter into menu. In menu screen, press this key can move cursor and confirm set information.
	Up/Mute	In main screen, press the key to scroll up screen. In menu interface, press this key to move up cursor or increase value. In main interface, press longer to mute alarm.
	Down/ Lamp Test	In main screen, press the key to scroll down screen. In menu interface, press this key to move down cursor or decrease value. In main screen, press the key longer to enter lamp test mode, LCD is backlit and all LED lamps are lit and LCD screen display goes black.

## 7 LCD DISPLAY

### 7.1 MAIN SCREEN

**Table 7 - Screen Display**

Items	Display Contents
Homepage	S1 power status, S2 power status, switch status; Supply system diagram; S1/S2 voltage and frequency; S1/S2 switching priority; Genset status; Breaker position information; AutoTrans/Restore status;
S1 Power S2 Power	S1 line voltage, phase voltage and frequency, phase angle. S2 line voltage, phase voltage and frequency, phase angle.
Load 	3-phase current (I1,I2,I3); 3-Phase Active Power kW (P1,P2,P3); 3-Phase Reactive Power Kvar (Q1,Q2,Q3); 3-Phase Apparent Power kVA(S1,S2,S3); Total Active Power kW (sum of P1,P2,P3); Total Reactive Power kvar (sum of Q1,Q2,Q3); Total Apparent Power kVA(sum of S1,S2,S3); 3-Phase Power Factor PF(PF1,PF2,PF3); Average Power Factor PF(average of PF1,PF2,PF3);
S1 Total  S2 Total	S1 Total Active Power; S1 Total Reactive Power; MS1 Close Times; BPS1 Close Times; S2 Total Active Power; S2 Total Reactive Power; MS2 Close Times; BPS2 Close Times;
Supply Time 	S1 Total Supply Time; S2 Total Supply Time; Power Supply Time (currently); Continuous Power Supply Time (Last Time);
I/O 	Programmable digital input status and auxiliary status; Programmable digital output status and LONO supply status;
Comm. 	RS485-1 Comm. Status and Baud Rate; RS485-2 Comm. Status and Baud Rate; USB Comm. Status
Alarms 	Present alarm informations (Warning Alarm and Fault Alarm)

Items	Display Contents
SYNC 	Voltage difference; Frequency difference; Phase difference; Only for HAT880S.
Status	Alarm status/working status; Real-time clock; Status line is showed below in each main screen page.

## 7.2 STATUS DESCRIPTION

**Table 8 - S1 Voltage Status**

No.	Item	Description
1	S1 Available	S1 Normal Delay;
2	S1 Unavailable	S1 Abnormal Delay;
3	S1 Available	Power supply voltage is within the setting range.
4	S1 Blackout	Voltage is 0;
5	S1 Over Volt	Voltage is higher than the set upper value;
6	S1 Under Volt	Voltage is below the set lower value;
7	S1 Over Freq	Frequency is higher than the set upper value;
8	S1 Under Freq	Frequency is below the set lower value;
9	S1 Loss of Phase	Loss of one or two phases among A, B and C;
10	S1 Phase Seq Wrong	A-B-C phase sequence is wrong.

**Table 9 - S2 Voltage Status**

No.	Item	Description
1	S2 Available	S2 Normal Delay;
2	S2 Unavailable	S2 Abnormal Delay;
3	S2 Available	Power supply voltage is within the setting range.
4	S2 Blackout	Voltage is 0.
5	S2 Over Volt	Voltage is higher than the set upper value.
6	S2 Under Volt	Voltage is below the set lower value.
7	S2 Over Freq	Frequency is higher than the set upper value.
8	S2 Under Freq	Frequency is below the set lower value.
9	S2 Loss of Phase	Loss of one or two phases among A, B and C;
10	S2 Phase Seq Wrong	A-B-C phase sequence is wrong.



**Table 10 - Genset Status**

No.	Item	Description
1	Genset Start Delay	Delay time before genset start;
2	Genset Stop Delay	Delay time before genset stop;
3	Scheduled Not Work	When scheduled not run is active, its duration time will be displayed.
4	Scheduled Work	When scheduled run is active, its duration time will be displayed.
5	S1 Cycle Run	S1 cycle run countdown will be terminated when cycle start is active.
6	S2 Cycle Run	S2 cycle run countdown will be terminated when cycle start is active.
7	S1 Genset Working	Active only when system has 2 gensets and S1 is generating.
8	S2 Genset Working	Active only when system has 2 gensets and S2 is generating.
9	Genset Working	Genset start signal outputs.
10	Genset Standby	There is no start genset signal output.

SmartGen



**Table 11 - Switch Status**

No.	Item	Description
1	Ready to Transfer	Switch transfer begins.
2	Closing MS1	MS1 closing delay is in progress.
3	Opening MS1	MS1 opening delay is in progress.
4	Closing MS2	MS2 closing delay is in progress.
5	Opening MS2	MS2 opening delay is in progress.
6	Transfer Rest	Interval time between switch transfer
7	Closing MS1 Again	It's the second close time when first MS1 open fails if the re-close delay is not 0.
8	Opening MS1 Again	It's the second open time when first MS1 close fails if the re-open delay is not 0.
9	Closing MS2 Again	It's the second close time when first MS2 open fails if the re-close delay is not 0.
10	Opening MS2 Again	It's the second open time when first MS2 close fails if the re-open delay is not 0.
11	Waiting for Sync	Delay time for waiting sync conditions (volt difference, freq. difference, and phase difference) of MS1 and MS2 are satisfied.
12	MS1 Sync Close	After Sync conditions are satisfied, MS1 Sync close outputs.
13	MS2 Sync Close	After Sync conditions are satisfied, MS2 Sync close outputs.
14	Waiting MS1 PF	Before MS1 is closed, it's the delay time to confirm "S1 PF Input" signal is active.
15	Waiting MS2 PF	Before MS2 is closed, it's the delay time to confirm "S2 PF Input" signal is active.
16	Elevator Delay	Delay time before ATS transfer, and elevator control outputs.
17	MS1 On Load	Main switch S1 was already closed and S1 is taking load.
18	MS2 On Load	Main switch S2 was already closed and S2 is taking load.
19	Offload	Switch was already opened and load is disconnected.
20	Closing Bypass S1	Delay for bypass S1 closing.
21	Opening Bypass S1	Delay for bypass S1 opening.
22	Closing Bypass S2	Delay for bypass S2 closing.
23	Opening Bypass S2	Delay for bypass S2 opening.
24	Bypass S1 On Load	Bypass S1 was closed and S1 is taking load.
25	Bypass S2 On Load	Bypass S2 was closed and S2 is taking load.
26	S1 Parallel On Load	Main and bypass in parallel provides power supply.
27	S2 Parallel On Load	Main and bypass in parallel provides power supply.
28	Waiting for Sync	Delay time for waiting sync conditions (volt difference, freq. difference, and phase difference) of BPS1 and BPS2 are satisfied.
29	BPS1 Sync Close	After Sync conditions are satisfied, BPS1 Sync close outputs.
30	BPS2 Sync Close	After Sync conditions are satisfied, BPS2 Sync close outputs.

Warning alarms are active when controller detects the alarm signals, and alarm indicator will flash slowly (1 time per sec). When alarm is reset, indicator is extinguished, which means warn alarms are not latched.

**Table 12 - Warning Alarms**

No.	Item	Description
1	S1 Over Current Warn	When the S1 current has exceeded the pre-set value and the action selects "Warn", it will initiate a warning alarm.
2	S2 Over Current Warn	When the S2 current has exceeded the pre-set value and the action selects "Warn", it will initiate a warning alarm.
3	Forced Open Warn	When the input is active and the action (cut off non-fire supply) selects "Warn", it will initiate a warning alarm.
4	Battery Under Volt	When the battery voltage has fallen below the pre-set value, it will initiate a warning alarm.
5	Battery Over Volt	When the battery voltage has exceeded the pre-set value, it will initiate a warning alarm.
6	Fail to Sync	When sync waiting is overtime and fail to sync action selects "Warn", it will initiate a warning alarm.

Fault alarms are active when controller detects the alarm signals. Alarm indicator will flash rapidly (5 times per sec) and the alarm will last until it was removed manually. Fault alarms are latched.

**Table 13 - Fault Alarms**

No.	Item	Description
1	S1 Failed to Close	S1 fails to close when S1 is closing.
2	S1 Failed to Open	S1 fails to open when S1 is opening.
3	S2 Failed to Close	S2 fails to close when S2 is closing.
4	S2 Failed to Open	S2 fails to open when S2 is opening.
5	S1 Over Current Trip	When the S1 is taking load and its current has exceeded the pre-set value, and the action selects "Trip", it will initiate a trip alarm.
6	S2 Over Current Trip	When the S2 is taking load and its current has exceeded the pre-set value and the action selects "Trip", it will initiate a trip alarm.
7	Forced Open Fault	When the input is active and the action (cut off non-fire supply) selects "Fault", it will initiate a fault alarm.
8	S1 Genset Fault	Only when system has 2 gensets and S1 is generating, S1 fails to start.
9	S2 Genset Fault	Only when system has 2 gensets and S2 is generating, S2 fails to start.
10	Switch Trip Alarm	It will initiate a fault alarm, when the input is active.
11	Fail to Sync	When sync waiting is overtime and fail to sync action selects "Fault", it will initiate a fault alarm. (only active in auto mode)

The indication information will continuously display for 2s after it is active.

**Table 14 - Indication Information**

No.	Item	Description
1	Please Reset The Alarm	When there is fault alarm occurs, the indication will be displayed when the genset mode is changed to Auto Mode manually.
2	S1 Already Closed.	The indication information for pressing S2 Close key when S1 is already closed.
3	S2 Already Closed.	The indication information for pressing S1 Close key when S2 is already closed.
5	Panel Locked	The information when panel lock is active and keys are pressed (except for Up/Down/Confirm/Return keys).

**Table 15 - Other Status Information**

No.	Item	Description
1	Start Inhibit	Genset start inhibit input is active.
2	Remote Inhibit	Remote control inhibit input is active.
3	S1 Load Inhibit	S1 load inhibit input is active.
4	S2 Load Inhibit	S2 load inhibit input is active.
5	NEL 1 Trip	NEL1 off load signal is outputted.
6	NEL2 Trip	NEL2 off load signal is outputted.
7	NEL3 Trip	NEL3 off load signal is outputted.
8	Remote Gen On Load	Remote start (on load) signal is active.
9	Remote Gen Off Load	Remote start (off load) signal is active.
10	Gen Start Mains NG	Start genset when Mains is abnormal.
11	Cycle Start Mode	Active when S1 and S2 are both generating.
12	Balanced Running Start Mode	Active when S1 and S2 are both generating.
13	Master/Backup Start Mode	Active when S1 and S2 are both generating.
14	Auto Mode	Current mode is Auto mode.
15	Manual Mode	Current mode is Manual mode.



### 7.3 MAIN MENU

In main screen, press  key to enter into the menu interface.

<ul style="list-style-type: none"><li>1. Configuration</li><li>2. Data Calibration</li><li>3. Historical Records</li><li>4. Black Box Records</li><li>5. AutoTrans./Restore</li><li>6. Start/Stop Genset</li><li>7. Language</li><li>8. About</li></ul>	<p>Press <b>Up/Down</b> key to choose parameters (the current line was highlighted with black) and then press <b>Confirm</b> key to enter into the corresponding display screen.</p>
---	--

**NOTE1:** Default password is 01234 before going into parameter setting, users can change it to prevent others changing the parameter settings. Please clearly remember the password after changing. If you forget it, please contact SmartGen services.

**NOTE2:** Data Calibration is for factory use only and factory password must be inputted before using it.







## 8 START/STOP OPERATION

### 8.1 MANUAL START/STOP

#### 8.1.1 PANEL START/STOP

In the main screen, press Set key to enter menu interface, and choose “Manual Test Genset” and press Confirm key, manual start operation interface is entered.

Manual Test Genset	Press “Up/Down” key to choose parameters (the current line was highlighted with black) and then press “Confirm” key to confirm.
0. Return 1. Genset Stop 2. Genset Start	

**Genset Stop:** Disconnect the start signal, i.e. stop the running genset.

**Genset Start:** Output the start signal, i.e. start the genset.

When system is “S1 Gens S2 Gens S3 Mains”, manual start/stop menu interface is as follows:

Manual Test Genset	Press “Up/Down” key to choose parameters (the current line was highlighted with black) and then press “Confirm” key to confirm.
0. Return 1. S1 Genset Stop 2. S1 Genset Start 3. S2 Genset Stop 4. S2 Genset Start	

**S1 Genset Stop:** Disconnect the S1 start signal, i.e. stop the running S1 genset.

**S1 Genset Start:** Output the S1 start signal, i.e. start the S1 genset.

**S2 Genset Stop:** Disconnect the S2 start signal, i.e. stop the running S2 genset.

**S2 Genset Start:** Output the S2 start signal, i.e. start the S2 genset.

#### 8.1.2 REMOTE START/STOP

Send remote start/stop signals using MODBUS protocol via RS485 port.

**Remote Stop:** Disconnect the start signal, i.e. stop the running genset.

**Remote Start:** Output the start signal, i.e. start the genset.

## 8.2 AUTO START/STOP

### 8.2.1 START CONDITIONS

#### 8.2.1.1 INPUT START

Set input port as “Remote Start On Load” or “Remote Start Off Load”, both could not be set simultaneously.

**Remote Start on Load:** Genset start is outputted and generating is normal, generating closes; when it is inactive, disconnect the genset start signal.

**Remote Start off Load:** Genset start is outputted and mains is normal, mains closes; when mains is abnormal and generating is normal, generating closes, and when it is inactive, the genset start signal is disconnected.

#### 8.2.1.2 Gen Start Mains NG

When mains is abnormal and the genset start is outputted; when generating is normal, generating closes.

#### 8.2.1.3 Gen Start Master

The start signal is outputted when generator has master priority.

### 8.2.2 GEN-GEN START/STOP

When system is “S1 Gens S2 Gens”, input port start/stop function is as follows:

**Remote Start on Load:** Detect S1 or S2 start output according to start mode. Genset close relay will active after genset is normal.

**Remote Start off Load:** Detect S1 or S2 start output according to start mode. Both genset S1 close relay and S2 close relay are deactivated after genset start.

S1 Gens S2 Gens start mode: Cycle Gen Start, Master-slave Gen Start, Balance Gen Hours, Not Used.

#### **Cycle Gen Start:**

When remote start is active, S1 and S2 starts according to circular running time. At the first time to start the genset, choose “S1 Start” or “S2 Start” depends on “Priority”. e.g. S1 starts firstly if “S1” has higher priority. Then S1 circular running countdown is started according to the preset delay. At the same time, genset fault check countdown starts. Before fault check if S1 is normal, then S1 takes load; when S1 circular running time is over, then S2 starts. S2 circular running countdown is initiated, at the same time genset fault check countdown is initiated. Before fault check countdown is over, if S2 is normal, S2 starts taking load and S1 stops. In such way, it lasts until remote start is inactive.

During the start process, if there is genset fault alarm (genset fault delay is overtime or genset fault input is active), fail to close or load inhibit alarm occurs, the starting genset will be stopped immediately and the additional genset will be started automatically.

During the circular running process, if “Manual Mode” is selected, the current status will be hold and the “cycle work time” will be suspended.

#### **Master-Slave Gen Start**

When remote start is active, master genset starts, during which if current genset faults (power supply delay is overtime or genset fault inputs occur for input ports), close failure, load inhibition occur, current genset is stopped immediately and start the other genset, otherwise master genset starts until remote start is inactive.

## Balance Gen Hours

The genset which has the shortest running hours will be started when remote start signal is active. During the start process, if current genset faults (power supply delay is overtime or ), close failure, load inhibition occur, current genset is stopped immediately and start the other genset, otherwise master genset starts until remote start is inactive.

For the system of "S1 Gens S2 Gens" to start/stop genset, it should meet following several conditions:

- 1) It is active in Auto mode;
- 2) System type is set as "S1 Gens S2 Gens";
- 3) Output port is set as "S1 genset start" and "S2 genset start";
- 4) Input port is set as "S1 genset fault input", "S2 genset fault input", and "remote start on load" or "remote start off load";
- 5) It is need to set "S1 Gen S2 Gen Start Mode";
- 6) It needs to configure and set "Genset Supply Delay". If start mode is cycle gen start, "S1 Cycle Work Time", "S2 Cycle Work Time" are also needed to set.

Among input ports, "S1 Genset Fault Input", "S2 Genset Fault Input" are optional settings, Genset faults can be judged by "Genset Supply Delay" and there is no need to inquire the fault alarm via input port.

When S1 Gen S2 Gen start type is configured as "Not Used", there is no genset start signals output.

### 8.2.3 SCHEDULED RUN

Once "Scheduled Run" is enabled, users can set the scheduled start time. Controller will send start signal at preset start time. Start signal will deactivated after the start delay has expired. "Scheduled Run On Load" or "Scheduled Run Off Load" can be set.

**Scheduled Run On Load:** When the input is active, genset close relay will active after genset is normal.

**Scheduled Run Off Load:** When the input is active, mains close relay will active after mains is normal.

Circular time of Scheduled Start can be set as start monthly, weekly and daily.

**Start Monthly:** start month, start date and time can be set.

**Start Weekly:** Same start time of several days in a week can be set. e. g. Start the genset at 8:00 a.m. from Monday to Friday and it keeps 10 hours.

**Start Daily:** start the genset at same time everyday can be set.

### 8.2.4 SCHEDULED NOT RUN

Once "Scheduled Not Run" is enabled, users can set the "Scheduled Not Start" time. Start signal will deactivated at preset time and it will be inhibited before the delay has expired.

Circular time of "Scheduled Not Run" can be set as monthly, weekly and daily.

**Not Run Monthly:** not start month, not start date and time can be set.



**Not Run Weekly:** genset start at the same time in couple days of a week can be set. e. g. genset not start at 19:00 p.m. from Monday to Friday and it keeps 12 hours.

**Not Run Daily:** genset not start at same time everyday can be set.

 **NOTE3:** "Scheduled Not Run" operation is prior to "Scheduled Run" operation.

## 9 PARAMETERS CONFIGURATION

### 9.1 ILLUSTRATION

In the main interface, press /OK key to enter menu interface; choose **Configuration** and press /OK again to enter into password confirmation interface. If password is correct, enter into parameter setting interface, otherwise, exit to main interface directly. Factory default password is **01234**. In parameter configuration interface, press  key to return to the prior menu.

### 9.2 PARAMETER CONFIGURATION TABLE

**Table 16 - Parameter Configuration Form**

No.	Paramter Name	Range	Default	Description
<b>AC Setting</b>				
1	S1 Volt Normal	(0~3600) s	10	The delay from S1 voltage abnormal to normal.
2	S1 Volt Abnormal	(0~3600)s	5	The delay from S1 voltage normal to abnormal.
3	S2 Volt Normal	(0~3600)s	10	The delay from S2 voltage abnormal to normal.
4	S2 Volt Abnormal	(0~3600)s	5	The delay from S2 voltage normal to abnormal.
5	Master Set	(0~1)	0	0: S1 Master 1: S2 Master
6	System Type	(0~3)	0	0: S1M S2G 1: S1G S2M 2: S1M S2M 3: S1G S2G
7	AC System	(0~3)	0	0: 3 Phase,4 Wire (3P4W) 1: 3 Phase,3 Wire (3P3W) 2: 2 Phase,3 Wire (2P3W) 3: Single Phase,2 Wire (1P2W)
8	PT Fitted	(0~1)	0	0: Disable; 1: Enable
9	PT Primary	(30~30000)V	100	Primary voltage of potential transformer
10	PT Secondary	(30~1000)V	100	Secondary voltage of potential transformer
11	Rated Voltage	(0~30000)V	220	Rated voltage of AC system
12	Over Volt Warn	(0~1)	1	0: Disable ; 1: Enable
13	Set Value	(0~200)%	120	Upper limit value of voltage; it is abnormal if the value has exceeded the set value.
14	Return	(0~200)%	115	Upper limit return value of voltage; it is normal only when the value has fallen below the set value.



No.	Parameter Name	Range	Default	Description
15	Under voltage Warn	(0~1)	1	0: Disable ; 1: Enable
16	Set Value	(0~200)%	80	Lower limit value of voltage; it is abnormal if the value has fallen below the set value.
17	Return Value	(0~200)%	85	Lower limit return value of voltage; it is normal only when the value has exceeded the set value.
18	Rated Frequency	(10.0~75.0)Hz	50.0	Rated frequency of AC system
19	Over Frequency Warn	(0~1)	1	0: Disable ; 1: Enable
20	Set Value	(0~200)%	110	Upper limit value of frequency; it is abnormal if the value has exceeded the set value.
21	Return Value	(0~ 200)%	104	Upper limit return value of frequency; it is normal only when the value has fallen below the set value.
22	Under Frequency Warn	(0~1)	1	0: Disable ; 1: Enable
23	Set Value	(0~ 200)%	90	Lower limit value of frequency; it is abnormal if the value has fallen below the set value.
24	Return Value	(0~ 200)%	96	Lower limit return value of frequency; it is normal only when the value has exceeded the set value.
25	Phase Sequence Wrong	(0~1)	1	0: Disable ; 1: Enable
<b>Switch</b>				
1	Bypass Function Type	(0~1)	0	0:DBTSE 1: SBTSE
2	Bypass Switch Type	(0~2)	1	0:MTSE 1:RTSE 2: Mutual Backup RTSE
3	ATS Power Type	(0~1)	1	0: DC Power Supply 1: AC Power Supply
4	ATS Power Low Point	(0~100)%	70	The lowest AC voltage supply; Switch can't be transferred if it is lower than it.
5	ATS Power High Point	(0~200)%	130	The highest AC voltage supply; Switch can't be transferred if it is higher than it.
6	Auto Trans./Restore	(0~1)	1	0: Auto Trans./Non-Res. 1: Auto Trans./Restore
7	Fixed Close/Open Time	(0~1)	0	0: Disable ; 1: Enable Disable: The output time was judged by the close relay; the longest output time is up to the set delay. Enable: The output time lasts for the



No.	Paramter Name	Range	Default	Description
				preset time.
8	Close Delay	(0.1~20.0)s	5.0	Pulse time of close relay.
9	Open Delay	(0.1~20.0)s	5.0	Pulse time of open relay.
10	Transfer Interval	(1~9999)s	1	Interval time from S1 switch open to S2 switch close; or from S2 switch open to S1 switch close.
11	Again Close Time	(0~20.0)s	1.0	Close again occurs when the first open fails, and close again delay also starts. When the delay is over, then open occurs again. If open cannot happen, then failed to open alarm signal is sent.
12	Again Open Time	(0~20.0)s	1.0	Open again occurs when the first close fails, and open again delay also starts. When the delay is over, then close occurs again. If close cannot happen, then failed to close alarm signal is sent.
13	Switch Type	(0~1)	0	0: Two Breakings 1: One Breaking
14	Forced Open Action	(0~1)	0	0: Warn Alarm 1: Fault Alarm
15	Continually Close	(0~1)	0	0: Disable ; 1: Enable If close control is continous signal, and this function is needed, close time and open time are inactive.
16	Sync Enabled	(0~1)	0	0: Disable 1: Enable
17	Volt Diff. Enabled	(0~1)	0	0: Disable 1: Enable
18	Volt Diff.	(0~50)V	5	Max. volt difference at sucessful sync.
19	Freq Diff.	(0~0.50)Hz	0.20	Max. freq difference at sucessful sync.
20	Phase Diff.	(0~20) °	5	Max. phase difference at sucessful sync.
21	Fail to Sync Action	(0~1)	0	0: Warn Alarm 1: Fault Alarm After sync failed, it still waits to sync; until sync is finished it closes. For warning alarm, it is cleared when sync is finished or it exits from sync; For fault alarm, press alarm reset key to clear the alarm; In manual mode, only warning alarm is active; it is not based on set alarm actions.
22	Transfer On Sync Fail	(0~1)	0	0: Disable 1: Enable After sync fails, non-sync close shall be executed and none fail to sync alarms shall be issued (only active in auto mode).
23	Fail to Sync Delay	(0~9999)s	120	Waiting time for sucessful sync; sync fails when it is overtime.



No.	Parameter Name	Range	Default	Description
24	Breaker Feedback Time	(0.1~1.0)s	0.6	Sync close/open output delay starts at sync transfer, during which if correct close status is detected, stop to close/open pulse outputs; if delay is over, correct close status is not detected still, then fail to close/open alarm is initiated.
<b>Generator</b>				
1	Start Delay	(0~9999)s	1	When the genset is ready to start, start delay begins, after the start delay has expired, start signal will be initiated.
2	Stop Delay	(0~9999)s	5	When the genset is ready to stop, stop delay begins, after the stop delay has expired, stop signal will be initiated.
3	S1 Gen S2 Gen Start Mode	(0~3)	0	0: Cycle Gens 1: Master-Slave Gens 2: Balance Gens Hours 3: Not Used
4	S1 Cycle Work Time	(0~9999)min	720	S1 running time for cycle start
5	S2 Cycle WorkTime	(0~9999)min	720	S2 running time for cycle start
6	Supply Delay	(0~9999)s	120	Time from genset signal is sent to gen voltage is normal; if delay is over and voltage is still not abnormal, genset fault alarm occurs.
7	Battery Volt Enable	(0~1)	0	0: Disable ; 1: Enable
8	Battery LV Warn Enable	(0~1)	0	0: Disable ; 1: Enable
9	Battery LV Warn	(0~100.0)V	10.0	When battery voltage is below the set return, LV warning occurs.
10	Battery LV Return	(0~100.0)V	10.5	When voltage is above the set return, LV warning is removed.
11	Battery LV Delay	(0~3600)s	60	Delay time when voltage is below the LV warning limit; when delay is over, LV warning occurs.
12	Battery OV Warn Enable	(0~1)	0	0: Disable 1: Enable
13	Battery OV Warn	(0~100.0)V	30.0	When voltage is above the set limit, OV warning occurs.
14	Battery OV Return	(0~100.0)V	29.5	When voltage is below the set return, OV warning is removed.
15	Battery OV Delay	(0~3600)s	60	Delay time when voltage is above the OV warning limit; when the delay is over, OV warning occurs.
<b>Scheduler</b>				
1	Schedule Gen Enable	(0~1)	0	0: Disable ; 1: Enable



No.	Paramter Name	Range	Default	Description
2	Schedule Load	(0~1)	0	0: Off Load 1: On Load
3	Schedule Period	(0~2)	0	0: Monthly 1: Weekly 2: Daily
4	Schdule Monthly	Optional month		<input checked="" type="checkbox"/> January <input checked="" type="checkbox"/> February <input checked="" type="checkbox"/> March <input checked="" type="checkbox"/> April <input checked="" type="checkbox"/> May <input checked="" type="checkbox"/> June <input checked="" type="checkbox"/> July <input checked="" type="checkbox"/> August <input checked="" type="checkbox"/> September <input checked="" type="checkbox"/> October <input checked="" type="checkbox"/> November <input checked="" type="checkbox"/> December
		Day(1~31)	1	Date for genset start in every month.
5	Schedule Weekly	Optional week		<input checked="" type="checkbox"/> Sunday <input type="checkbox"/> Monday <input type="checkbox"/> Tuesday <input type="checkbox"/> Wednesday <input type="checkbox"/> Thursday <input type="checkbox"/> Friday <input type="checkbox"/> Saturday
6	Schdule Hours	(0~23)h	0	Scheduled time for starting genset.
7	Schdule Minutes	(0~59)min	0	
8	Schdule Work Time	(0~30000)min	30	Lasting time for scheduled running.
9	Gen Inhibit Work Set	(0~1)	0	0: Disable 1: Enable
10	Inhibit Period	(0~2)	0	0: Monthly 1: Weekly 2: Daily
11	Inhibit Monthly	Optional month		<input checked="" type="checkbox"/> January <input checked="" type="checkbox"/> February <input checked="" type="checkbox"/> March <input checked="" type="checkbox"/> April <input checked="" type="checkbox"/> May <input checked="" type="checkbox"/> June <input checked="" type="checkbox"/> July <input checked="" type="checkbox"/> August <input checked="" type="checkbox"/> September <input checked="" type="checkbox"/> October <input checked="" type="checkbox"/> November <input checked="" type="checkbox"/> December
		Day(1~31)	1	Date for not starting genset in each month
12	Inhibit Weekly	Optional week		<input checked="" type="checkbox"/> Sunday <input type="checkbox"/> Monday <input type="checkbox"/> Tuesday <input type="checkbox"/> Wednesday <input type="checkbox"/> Thursday <input type="checkbox"/> Friday <input type="checkbox"/> Saturday
13	Inhibit Hours	(0~23)h	0	Date of not starting the genset
14	Inhibit Minutes	(0~59)min	0	
15	Inhibit Rest Time	(0~30000)s	30	Lasting time of not starting the genset
<b>Load</b>				
1	Elevator Enable	(0~1)	0	0: Disable ; 1: Enable
2	Elevator Delay	(0~300)s	300	Delay time before load is power off and switch transfer, which is used to control the running elevator stops at the nearest floor until switch transfer is over.
3	Current CT Enable	(0~1)	1	0: Disable ; 1: Enable
4	CT Primary	(5~6000)A	500	CT primary current
5	S1 Full Load Rating	(5~6000)A	500	Full load current of S1 taking load
6	S2 Full Load Rating	(5~6000)A	500	Full load current of S2 taking load
7	S1 Max kW Rating	(1~20000)kW	200	The maximum active power of S1 taking load
8	S2 Max kW Rating	(1~20000)kW	200	The maximum active power of S2 taking





No.	Parameter Name	Range	Default	Description
				load
9	Over Current Enable	(0~1)	1	0: Disable ; 1: Enable
10	Over Load Current	(0~200)%	120	Over current set limit values
11	Over Current Action	(0~1)	0	0: Warn 1: Trip
12	Over Current Type	(0~1)	0	0: Definite Time 1: IDT(Inverse DefiniteTime)
13	Over Current Delay (value)	(0~3600)s	10	It's the over current delay time when "Definite Time" is selected.
14	Inverse Definite Delay (Multiplier)	(1~36)	36	It's the over current multiplier when "IDT" is selected.
15	NEL Trip Enable	(0~1)	0	0: Disable ; 1: Enable
16	NEL OverPower Val 1	(0~200)%	90	When load power is above the set value, and delay is over, unload control outputs.
17	NEL OverPowerDelay1	(0~3600)s	5	
18	NEL OverPower Val 2	(0~200)%	100	When load power is above the set value, and delay is over, unload control outputs.
19	NEL OverPowerDelay2	(0~3600)s	1	
20	NEL Return Enable	(0~1)	0	0: Disable ; 1: Enable
21	NEL Return Value	(0~200)%	50	When load power is below the set value, and delay is over, trip disconnection control outputs.
22	NEL Return Delay	(0~3600)s	5	
23	NEL Num	(1~3)	3	NEL number
24	Mains Load NEL Enable	(0~1)	0	0: Disable ; 1: Enable
<b>Digit Inputs</b>				
1	Digital Input 1	(0~50)	1	Forced Open
2	Active Type	(0~1)	0	0: Close to activate; 1: Open to activate
3	Digital Input 2	(0~50)	8	Breaker Trip Input
4	Active Type	(0~1)	0	0: Close to activate; 1: Open to activate
5	Digital Input 3	(0~50)	30	BTS Unlocked
6	Active Type	(0~1)	0	0: Close to activate; 1: Open to activate
7	Digital Input 4	(0~50)	31	ATS In Work
8	Active Type	(0~1)	0	0: Close to activate; 1: Open to activate
9	Digital Input 5	(0~50)	32	ATS In Test
10	Active Type	(0~1)	0	0: Close to activate;



No.	Paramter Name	Range	Default	Description
				1: Open to activate
11	Digital Input 6	(0~50)	35	ATS Unlocked
12	Active Type	(0~1)	0	0: Close to activate; 1: Open to activate
13	Digital Input 7	(0~50)	36	BTS In Work
14	Active Type	(0~1)	0	0: Close to activate; 1: Open to activate
15	Digital Input 8	(0~50)	37	BTS In Test
16	Active Type	(0~1)	0	0: Close to activate; 1: Open to activate
<b>Relay Outputs</b>				
1	Relay Output 1 Active Type	(0~1)	0	0: Output (NO) 1: Output (NC)
2	Relay Output 1	(0~105)	34	MS1 Close Control
3	Relay Output 2 Active Type	(0~1)	0	0: Output (NO) 1: Output (NC)
4	Relay Output 2	(0~105)	36	MS2 Close Control
5	Relay Output 3 Active Type	(0~1)	0	0: Output (NO) 1: Output (NC)
6	Relay Output 3	(0~105)	35	MS1 Open Control
7	Relay Output 4 Active Type	(0~1)	0	0: Output (NO) 1: Output (NC)
8	Relay Output 4	(0~105)	37	MS2 Open Control
9	Relay Output 5 Active Type	(0~1)	0	0: Output (NO) 1: Output (NC)
10	Relay Output 5	(0~105)	90	BPS1 Close Control
11	Relay Output 6 Active Type	(0~1)	0	0: Output (NO) 1: Output (NC)
12	Relay Output 6	(0~105)	92	BPS2 Close Control
13	Relay Output 7 Active Type	(0~1)	0	0: Output (NO) 1: Output (NC)
14	Relay Output 7	(0~105)	91	BPS1 Open Control
15	Relay Output 8 Active Type	(0~1)	0	0: Output (NO) 1: Output (NC)
16	Relay Output 8	(0~105)	93	BPS2 Open Control
17	Relay Output 9 Active Type	(0~1)	0	0: Output (NO) 1: Output (NC)
18	Relay Output 9	(0~105)	89	Parallel Power Supply Warning
19	Relay Output 10 Active Type	(0~1)	0	0: Output (NO) 1: Output (NC)
20	Relay Output 10	(0~105)	0	Not Used
21	Relay Output 11	(0~1)	1	0: Output (NO)



No.	Paramter Name	Range	Default	Description
	Active Type			1: Output (NC)
22	Relay Output 11	(0~105)	32	Genset start Output
23	Relay Output 12 Active Type	(0~1)	0	0: Output (NO) 1: Output (NC)
24	Relay Output 12	(0~105)	0	Not Used
25	Combined 1 Or Out 1 Active Type	(0~1)	0	0: Output (NO) 1: Output (NC)
26	Combined 1 Or Out 1 Contents Setting	(0~105)	23	S1 Available
27	Combined 1 Or Out 2 Active Type	(0~1)	0	0: Output (NO) 1: Output (NC)
28	Combined 1 Or Out 2 Contents Setting	(0~105)	25	S2 Available
29	Combined 1 And Out Active Type	(0~1)	1	0: Output (NO) 1: Output (NC)
30	Combined 1 And Out Contents Setting	(0~105)	0	Not Used
31	Combined 2 Or Out 1 Active Type	(0~1)	0	0: Output (NO) 1: Output (NC)
32	Combined 2 Or Out 1 Contents Setting	(0~105)	0	Not Used
33	Combined 2 Or Out 2 Active Type	(0~1)	0	0: Output (NO) 1: Output (NC)
34	Combined 2 Or Out 2 Contents Setting	(0~105)	0	Not Used
35	Combined 2 And Out Active Type	(0~1)	0	0: Output (NO) 1: Output (NC)
36	Combined 2 And Out Contents Setting	(0~105)	0	Not Used
37	Combined 3 Or Out 1 Active Type	(0~1)	0	0: Output (NO) 1: Output (NC)
38	Combined 3 Or Out 1 Contents Setting	(0~105)	0	Not Used
39	Combined 3 Or Out 2 Active Type	(0~1)	0	0: Output (NO) 1: Output (NC)
40	Combined 3 Or Out 2 Contents Setting	(0~105)	0	Not Used
41	Combined 3 And Out Active Type	(0~1)	0	0: Output (NO) 1: Output (NC)
42	Combined 3 And Out Contents Setting	(0~105)	0	Not Used
43	Combined 4 Or Out 1 Active Type	(0~1)	0	0: Output (NO) 1: Output (NC)



No.	Paramter Name	Range	Default	Description
44	Combined 4 Or Out 1 Contents Setting	(0~105)	0	Not Used
45	Combined 4 Or Out 2 Active Type	(0~1)	0	0: Output (NO) 1: Output (NC)
46	Combined 4 Or Out 2 Contents Setting	(0~105)	0	Not Used
47	Combined 4 And Out Active Type	(0~1)	0	0: Output (NO) 1: Output (NC)
48	Combined 4 And Out Contents Setting	(0~105)	0	Not Used
49	Combined 5 Or Out 1 Active Type	(0~1)	0	0: Output (NO) 1: Output (NC)
50	Combined 5 Or Out 1 Contents Setting	(0~105)	0	Not Used
51	Combined 5 Or Out 2 Active Type	(0~1)	0	0: Output (NO) 1: Output (NC)
52	Combined 5 Or Out 2 Contents Setting	(0~105)	0	Not Used
53	Combined 5 And Out Active Type	(0~1)	0	0: Output (NO) 1: Output (NC)
54	Combined 5 And Out Contents Setting	(0~105)	0	Not Used
55	Combined 6 Or Out 1 Active Type	(0~1)	0	0: Output (NO) 1: Output (NC)
56	Combined 6 Or Out 1 Contents Setting	(0~105)	0	Not Used
57	Combined 6 Or Out 2 Active Type	(0~1)	0	0: Output (NO) 1: Output (NC)
58	Combined 6 Or Out 2 Contents Setting	(0~105)	0	Not Used
59	Combined 6 And Out Active Type	(0~1)	0	0: Output (NO) 1: Output (NC)
60	Combined 6 And Out Contents Setting	(0~105)	0	Not Used
<b>Module Settings</b>				
1	Power On Mode	(0~2)	0	0: Last Mode (Keep the working mode before power off) 1: Manual Mode 2: Auto Mode
2	Language	(0~2)	0	0: Chinese 1: English 2: Other (Language can be set via PC software, Default: Traditional Chinese)
3	Password	(00000~65535)	01234	For entering parameter setting.



No.	Parameter Name	Range	Default	Description
4	Module Address	(1~254)	1	RS485 communication address (one module address is shared)
5	RS485-1 Baud	(0~3)	2	0: 2400 bps 1: 4800 bps 2: 9600 bps 3: 19200 bps
6	RS485-1 Stop Bit	(1~2)	2	2 stop bits or 1 stop bit can be set.
7	RS485-1 Parity	(0~2)	0	0:None Parity 1:Odd Parity 2:Even Parity
8	RS485-1 COM Set	(0~3)	0	0:Enable COMAdj/Ctrl 1:Disable COMControl 2:Disable COM Adjust 3:DisableCOMAdj/Ctrl
9	RS485-2 Baud Rate	(0~3)	2	0: 2400 bps 1: 4800 bps 2: 9600 bps 3: 19200 bps
10	RS485-2 Stop Bit	(1~2)	2	2 stop bits or 1 stop bit can be set.
11	RS485-2 Parity	(0~2)	0	0:None Parity 1:Odd Parity 2:Even Parity
12	RS485-2 COM Set	(0~3)	0	0:Enable COMAdj/Ctrl 1:Disable COMControl 2:Disable COM Adjust 3:DisableCOMAdj/Ctrl
13	Date/Time Set			
14	Key Tips Enable Set	(0~1)	0	0: Disable 1: Enable (Note: All keys except Return/Home, Set/Confirm, Up/Mute, Down/Lamp Test, are pressed and "Sure To Press?" reminder shall appear; Press Up, Down to confirm or cancel, and press Set to confirm the setting and the reminder shall disappear.
15	Controller Description 1	(0~20) characters		"About" information is displayed. Any characters can be inputted via PC software (letter occupies 1 character, Chinese character occupies 2.).
16	Controller Description 2	(0~20) characters		

### 9.3 DIGITAL INPUT/OUTPUT FUNCTION DESCRIPTION

#### 9.3.1 INPUT PORTS FUNCTION

**Table 17 - Input Port Function Description**

No.	Item	Description
0	Not Used	Invalid
1	Forced Open	No matter the genset is in manual mode or auto mode, when the input is active, this will force the breaker to transfer the ATS to OFF position. "No Breaking" ATS is unavailable.
2	Remote StartOnLoad	Genset start output: when Mains is normal, gen breaker closes.
3	Remote StartOffLoad	Genset start output: when Mains is abnormal, mains breaker closes.
4	Lamp Test	All indicators on the panel are light on; LCD backlight is on; LCD is dark.
5	Gen1 Fault Input	In cycle start, if the input is active, S1 Gens start will be inhibited.
6	Gen2 Fault Input	In cycle start, if the input is active, S2 Gens start will be inhibited.
7	Start Inhibit Input	Inhibit genset start signal output; in auto mode, after stop delay, it will disconnect genset start signal output; in manual mode, if genset has started, then it needs to stop the genset manually; when it is stopped, start is inactive.
8	Breaker Trip Input	Trip failure input
9	S1 Close Inhibit	In manual mode, S1 manual close is inhibited; if breaker is already closed, users should open it manually. In auto mode, if breaker is already closed, then close relay will deactivated or S2 take load.
10	S2 Close Inhibit	In manual mode, S2 manual close is inhibited; if breaker is already closed, users should open it manually. In auto mode, if breaker is already closed, then close relay will deactivated or S1 take load.
11	QS1 Breaker PF Input	When the S1 PF input is active, S1 close relay will be activated.
12	QS2 Breaker PF Input	When the S2 PF input is active, S2 close relay will be activated.
13	Reserved	
14	Reserved	
15	Alarm Reset	Reset the current alarm.
16	Alarm Mute	Silence the audible alarm.
17	NEL Trip Key	Control the NEL off load manually. Self-reset button is recommended.
18	NEL Return Key	Control the NEL on load again manually. Self-reset button is recommended.
19	S1 Master Input	Set S1 master use compulsively.
20	S2 Master Input	Set S2 master use compulsively.
21	Forced Manual Mode	Set the controller in Manual mode compulsively.
22	Forced Auto Mode	Set the controller in Auto mode compulsively.
23	Panel Lock	Panel button operation is inhibited (Except Up, Down, Confirm, Return, Reset and Mute keys)
24	Sync Transfer Inhibit	When it is active, sync transfer function is inactive. (HAT880S)
25	Scheduler Inhibit	Schedule Start and Schedule Not Start function are deactivated.
26	Simulate S1 OK	Simulate S1 voltage is normal; the S1 voltage abnormal delay is



No.	Item	Description
		deactivated.
27	Simulate S2 OK	Simulate S2 voltage is normal; the S2 voltage abnormal delay is deactivated.
28	Reserved	
29	Reserved	
30	BTS Unlocked Out	BTS unlocked status input; bypass indicator shall be illuminated and bypass switch is available when it is active.
31	ATS In Work	Main ATS is in working position.
32	ATS In Test	Main ATS is in testing position.
33	Reserved	
34	Reserved	
35	ATS Unlocked Out	ATS unlocked status input; ATS indicator shall be illuminated and main switch is available when it is active.
36	BTS In Work	BTS is in working position.
37	BTS In Test	BTS is in testing position.
38	Overhaul Unlock	Overhaul unlock output lasts for 1min when its input port (Self-recover button) is triggered and active.
39	AutoTrans./Rec.	Active when it is active, and Auto transfer and non-recover when it is not active.
40	Reserved	
41	MS1 Close Key	Same as MS1 Close key on the panel, which is used to control S1 close, and Self-recover button shall be chosen.
42	Main Open Key	Same as open key of main switch, which is used to control switch open, and Self-recover button shall be chosen.
43	MS2 Close Key	Same as MS2 Close key on the panel, which is used to control S2 close, and Self-recover button shall be chosen.
44	BPS1 Close Key	Same as bypass S1 Close key on the panel, which is used to control bypass S1 close, and Self-recover button shall be chosen.
45	Bypass Open Key	Same as open key of bypass switch, which is used to control bypass switch open, and Self-recover button shall be chosen.
46	BPS2 Close Key	Same as bypass S2 Close key on the panel, which is used to control bypass S2 close, and Self-recover button shall be chosen.
47	M/BP Key	Same as unlock key of main/bypass on the panel to transfer between main/bypass switch status, and Self-recover button shall be chosen.
48	MAN/AUTO Key	Same as Manual/Auto key, which is used to control simulate manual/auto mode transfer, and Self-recover button shall be chosen.
49	Remote Control Inhibit	Remote control is invalid when the input is active.
50	Reserved	

### 9.3.2 OUTPUT PORTS FUNCTION

**Table 18 - Output Port Function Description**

No.	Items	Description
0	Not Used	Invalid
1	Custom Combined 1	For details please refer to the back description.
2	Custom Combined 2	
3	Custom Combined 3	
4	Custom Combined 4	
5	Custom Combined 5	
6	Custom Combined 6	
7	Reserved	
8	Reserved	
9	Reserved	
10	Reserved	
11	Common Alarm	It includes fault alarm and warning alarm.
12	Common Fault Alarm	It includes Transition Fault alarm and Over Current Trip alarm.
13	Common Warn Alarm	It includes "S1 Phase Sequence Wrong" alarm, "S2 Phase Sequence Wrong" alarm, and "Forced Open" alarm.
14	Transition Fault	It includes "S1 Fail to Close" alarm, "S1 Fail to Open" alarm, "S2 Fail to Close" alarm, "S2 Fail to Open" alarm.
15	Audible Alarm	When common alarm is active, annunciator can be connected externally. When "alarm mute" input is active in input port or 60s delay has expired, it can remove the alarm.
16	Reserved	
17	Genset Start Delay	Output when start signal is initiated.
18	Genset Stop Delay	Output when stop signal is initiated.
19	Elevator Control	Output before the load disconnected or switch transfer. Used to control the running elevator stop at the nearest floor until the switch transfer is terminated.
20	Overhaul Unlock Out	Unlock output lasts for 1min when input port (Self-recover button) is triggered and active.
21	Reserved	
22	Reserved	
23	S1 Available	Output when S1 power is normal.
24	S1 Unavailable	Output when S1 power is abnormal.
25	S2 Available	Output when S2 power is normal.
26	S2 Unavailable	Output when S2 power is abnormal.
27	S1 Over Current	Output when S1 over current occurs.
28	S2 Over Current	Output when S2 over current occurs.
29	Reserved	
30	Auto Mode	Output when the genset is in Auto mode.
31	Manual Mode	Output when the genset is in Manual mode.
32	Genset Start Output	Control the genset to start.





No.	Items	Description
33	Reserved	
34	MS1 Close Control	Control the MS1 switch to close.
35	MS1 Open Control	Control the MS1 switch to open.
36	MS2 Close Control	Control the MS2 switch to close.
37	MS2 Open Control	Control the MS2 switch to open.
38	Reserved	
39	Reserved	
40	NEL 1 Trip	It controls NEL offload when output is active; it controls NEL offload return (on load) when output is inactive.
41	NEL 2 Trip	
42	NEL 3 Trip	
43	Reserved	
44	Reserved	
45	MS1 On Feedback	The close status of S1 switch
46	MS2 On Feedback	The close status of S2 switch
47	S1 Genset Start	When the system type is "S1 Gen S2 Gen", it controls the S1 genset start.
48	S2 Genset Start	When the system type is "S1 Gen S2 Gen", it controls the S2 genset start.
49	Reserved	
50	Reserved	
51	Reserved	
52	Reserved	
53	Remote Control	Control the output via remote communication command.
54	Input 1 Status	Configurable Input status.
55	Input 2 Status	
56	Input 3 Status	
57	Input 4 Status	
58	Input 5 Status	
59	Input 6 Status	
60	Input 7 Status	
61	Input 8 Status	
62	Reserved	
63	Reserved	
64	S1 Blackout	S1 power supply status
65	S1 Over Volt	
66	S1 Under Volt	
67	S1 Over Freq	
68	S1 Under Freq	
69	S1 Loss Of Phase	
70	S1 Phase Seq Wrong	
71	Reserved	
72	Reserved	
73	S2 Blackout	S2 power supply status



No.	Items	Description
74	S2 Over Volt	
75	S2 Under Volt	
76	S2 Over Freq	
77	S2 Under Freq	
78	S2 Loss Of Phase	
79	S2 Phase Seq Wrong	
80	Reserved	
81	Reserved	
82	Fail to Sync	Output when sync fails (HAT880S);
83	Waiting for Sync	Output when it is waiting for sync (HAT880S);
84	Switching	Output during the switch transfer process.
85	Battery Under Volt	Output when battery under voltage alarm occurs.
86	Battery Over Volt	Output when battery over voltage alarm occurs.
87	Gen Inhibit Work	Output during the Schedule Not Run process.
88	Scheduler Gen Start	Output during the Schedule Run process.
89	Parallel Supply	Both of S1 close for main and bypass switches when they are in working position.
90	BPS1 Close Out	Control bypass S1 close.
91	BPS1 Open Out	Control bypass S1 open.
92	BPS2 Close Out	Control bypass S2 close.
93	BPS2 Open Out	Control bypass S2 open.
94	BPS1 On Feedback	Output when bypass S1 is already closed.
95	BPS2 On Feedback	Output when bypass S2 is already closed.
96	BTS Unlocked Out	Output when bypass BTS is unlocked.
97	ATS In Work	Position status for main ATS.
98	ATS In Test	
99	ATS In Isolation	
100	ATS Unlocked Out	Output when main ATS is unlocked.
101	BTS In Work	Position status for bypass switch BTS.
102	BTS In Test	
103	BTS InIsolated	
104	Reserved	
105	Reserved	

### 9.3.3 CUSTOM COMBINATION OUTPUT

Defined combination output is composed by 3 parts, OR conditional output SW1, OR conditional output SW2, AND conditional output SW3.

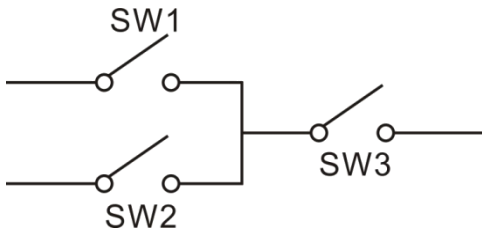

SW1 or SW2 is **TRUE**, while SW3 is **TRUE**, defined combination output is active;

SW1 and SW2 are **FALSE**, or SW3 is **FALSE**, defined combination output is deactivated.

**NOTE4:** SW1, SW2, SW3 can be set as any contents except for “defined combination output” in the output setting.

**NOTE5:** 3 parts of defined combination output (SW1, SW2, SW3) couldn't include or recursively include themselves.

Example:

Contents of OR condition output SW1: output port 1 is active;

Close when OR condition output SW1 is active /inactive: close when active (disconnect when inactive);

Contents of OR condition output SW2, output port 2 is active;

Close when OR condition output SW2 is active /inactive: close when active (disconnect when inactive);

Contents of AND condition output SW3: output port 3 is active;

Close when AND condition output SW3 is active /inactive: close when active (disconnect when inactive);

When input port 1 is active or input port 2 is active, if input port 3 is active, defined combination output is outputting; If input port 3 is inactive, defined combination output is not outputting;

When input port 1 is inactive and port 2 is inactive, no matter port 3 is active or not, defined combination output is not outputting.

### 9.4 DEFINITE TIME AND INVERSE DEFINITE TIME OF OVER CURRENT

**Definite Time:** overcurrent delay is definite time. Different overcurrent value has the same preset delay.

**Inverse Definite Time :** overcurrent delay decreases as overcurrent increases. Different overcurrent value has different corresponding delay.

Inverse overcurrent delay formula:

$$T = t / ((IA/IT)-1)^2$$

T: Overcurrent delay (second)

t: Timing multiplier ratio

IA: Current max. load current (L1/L2/L3)

IT: Set overcurrent value

Example:

$$t = 36$$



$$IA = 550A$$

$$IT = 500A$$

$$\text{Conclusion: } T = 3600s(1\text{hour})$$



## 10 HISTORICAL RECORDS

In the main screen press  key to enter menu page and select **Historical Records**, and then press  key to confirm, the screen will show the historical records interface.

Each record includes:

- Record date and time
- Record type
- Event log
- S1 power supply status
- S2 power supply status
- S1 3-phase voltage
- S2 3-phase voltage
- S1 frequency
- S2 frequency
- Current IA、IB、IC
- Active power
- Power factor

Maximum pieces of historical record are 200. The first record is latest, and users could check every record by dredging up/down. The latest record will cover the oldest one when record amount exceeds 200.



Event log type includes: Action Event, Warning Event and Fault Event. All fault event actions are fault alarms while all warning event actions are warning alarm.



**Table 19 – Action Event List**

No.	Action Events	Description
1	MS1 Closing	Record when the MS1 close outputs.
2	MS2 Closing	Record when the MS2 close outputs.
3	Main Opening	Record when main switch open outputs.
4	MS1 Sync Close	Record when MS1 sync close occurs;
5	MS2 Sync Close	Record when MS2 sync close occurs;
6	NEL 1 UnLoad	Record when NEL 1 unload control outputs.
7	NEL 2 UnLoad	Record when NEL 2 unload control outputs.
8	NEL 3 UnLoad	Record when NEL 3 unload control outputs.
9	Genset Start	Record when genset start signal outputs.
10	S1 Genset Start	Record when S1 genset start signal outputs.
11	S2 Genset Start	Record when S2 genset start signal outputs.
12	Genset Stop	Record when genset start signal is deactivated.
13	S1 Genset Stop	Record when S1 genset start signal is deactivated.
14	S2 Genset Stop	Record when S2 genset start signal is deactivated.
15	Auto Mode	Record when the genset mode transferred to Auto Mode.
16	Manual Mode	Record when the genset mode transferred to Module Mode.
17	BPS1 Close	Record when BPS1 close outputs.
18	BPS2 Close	Record when BPS2 close outputs.
19	Bypass Open	Record when bypass switch open outputs.
20	BPS1 Sync Close	Record when BPS1 close outputs;
21	BPS2 Sync Close	Record when BPS2 close outputs;
22	Manual MS1 Close	Operate MS1 close manually.
23	Manual MS2 Close	Operate MS2 close manually.
24	Manual Main Open	Operate main switch open manually.
25	Manual BPS1 Close	Operate BPS1 close manually.
26	Manual BPS2 Close	Operate BPS2 close manually.
27	Manual Bypass Open	Operate bypass switch open manually.
28	Auto MS1 Close	MS1 close in auto mode.
29	Auto MS2 Close	MS2 close in auto mode.
30	Auto Main Open	Main switch open in auto mode.
31	Auto BPS1 Close	BPS1 close in auto mode.
32	Auto BPS2 Close	BPS2 close in auto mode.
33	Auto Bypass Open	Bypass switch open in auto mode.

## 11 BLACK BOX RECORDS

In the main screen press /OK key to enter menu page and select **Black Box Records**, and then press /OK key again to confirm, the screen will show the black box records interface.

Each record includes:

- Record date and time
- Record type
- Event log
- S1 power supply status
- S2 power supply status
- S1 3-phase voltage
- S2 3-phase voltage
- S1 frequency
- S2 frequency
- Current IA、IB、IC
- Active power
- Power factor

Maximum pieces of black box record are 5. Every event records all data information of this event in previous and backward 60s, and record once per second. The latest record will cover the oldest one when record amount exceeds 5. The first record is latest. Users could check details by pressing Confirm key, and check the 60 datas by dredging up/down.

Event log type: the action event of close/open switching in auto mode.

**Table 20 – Action Event List**

No.	Action Events	Description
1	Auto MS1 Close	MS1 close in auto mode.
2	Auto MS2 Close	MS2 close in auto mode.
3	Auto Main Open	Main switch open in auto mode.
4	Auto BPS1 Close	BPS1 close in auto mode.
5	Auto BPS2 Close	BPS2 close in auto mode.
6	Auto Bypass Open	Bypass switch open in auto mode.

## 12 SWITCH OPERATION

### 12.1 MANUAL OPERATION

Controller shall be in manual mode by pressing  button and a LED beside the button will illuminate.

In manual mode users can control switch transfer by the keys on the panel.

Manual Bypass Switch:

Bypass switch transfer can only operated manually and bypass close/open keys are inactive.

Remote Bypass Switch:

Main switch and bypass switch both can be operated to close or open on the controller. Switch transfer can also be realized manually via panel keys under the following conditions.

**Table 21 – Manual Remote Control of Dual Bypass Switch**

Switch	Bypass Switch Locked			Bypass Switch Unlocked		
	Main Switch Work	Main Switch Test	Main Switch Isolation	Main Switch Work	Main Switch Test	Main Switch Isolation
Main Switch	Operable	Operable	Inoperable	Inoperable	Inoperable	Inoperable
Bypass Switch	Inoperable	Inoperable	Inoperable	Operable	Operable	Operable

Mutual Backup Bypass Switch:

Mutual backup bypass switch means main switch and bypass switch can be backup mutually, and main switch and bypass switch can separately be master and backup.

**Table 22 – Mutual And Dual Backup Bypass Switchs**

Manual Close/Open	Master Unlocked, Bypass Locked			Master Locked, Bypass Unlocked		
	Main Switch Work	Main Switch Test	Main Switch Isolation	Main Switch Work	Main Switch Test	Main Switch Isolation
Bypass Work	▲	▲		■	■	■
Bypass Test	▲	▲		■	■	■
Bypass Isolation	▲	▲				

▲ Manual operation for master switch close/open; ■ Manual operation for bypass switch close/open

For single bypass system, only bypass S1 close/open can be operated, and bypass S2 close/open can't be operated and the corresponding S2 close/open keys are invalid.

### 12.2 AUTOMATIC OPERATION

Controller shall be in auto mode by pressing the  button and a LED beside the button will illuminate. Controller can automatically transfer S1 or S2 power supply according to master settings and other conditions, meanwhile automatically control genset start according to main abnormal start and other start conditions.

### 12.3 SYNCHRONIZING CLOSE

Synchronizing close is transferring current power side to the other power supply under normal condition of both S1 and S2. During this process synchronizing transfer is needed.

**Sync. Close Enable:** when this is active, sync close function is active, otherwise sync. close function cannot be executed.

**Sync. Volt Difference:** Maximum volt difference between S1 and S2 at synchronization; if it is enabled, volt difference won't be detected in synchronizing process.

**Sync. Freq. Difference:** Maximum frequency difference between S1 and S2 at synchronization.

**Sync. Phase Difference:** Maximum phase difference between S1 and S2 at synchronization. Usually phase difference shall not be set too big. Otherwise, load impact will be too big at closing.

**Fail To Sync Action:** Warning alarm or fault alarm can be set; after sync failure, it continues waiting for sync until sync close is finished. For warning alarm when sync is completed or it exits from sync, alarm shall be cleared; for fault alarm, it needs alarm reset key to clear the alarm.

**Transfer On Sync Fail:** When this is enabled, after sync fails, non sync close will be conducted and no sync failure alarm shall be issued.

**Fail To Sync Delay:** Waiting time for sync; it shall issue sync failure alarm when it is overtime.

**Breaker Feedback Time:** Pulse time for synchronizing close; at the time of synchronizing transfer, sync close/open output delay starts; in the delay process if correct close status is detected, then stop the close/open pulse output; if after delay is over, correct close status still cannot be detected, close/open failure alarm shall be initiated.

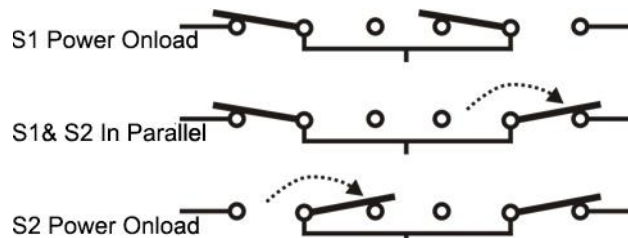

**Fig. 3 - Sync Transfer Diagram**

### 12.3.1 S1 SYNC CLOSE

S1&S2 power voltages are normal. S2 is onload, and S1 close pulse outputs. Until S1 close status is detected or delay is up to sync close/open detection time, disconnect S1 close pulse output. At the same time S2 open pulse outputs; until S2 open status is detected or delay is over sync close/open detection time, disconnect S2 open pulse outputs. In synchronizing process if close/open time is over sync close/open detection time, then close/open failure alarm is initiated.

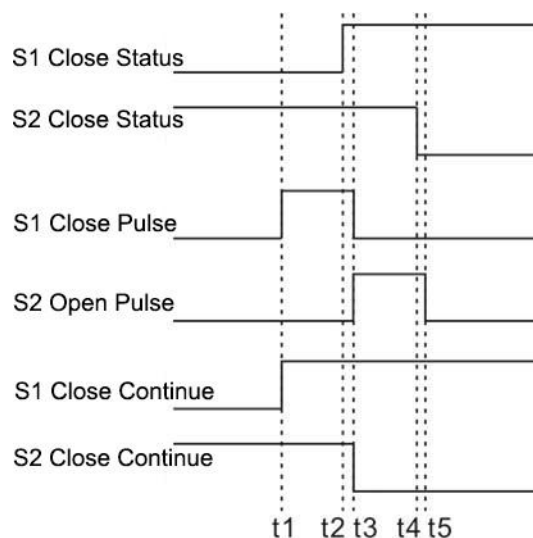

**Fig. 4 - S1 Sync Close Procedure Oscillogram**



### 12.3.2 S2 SYNC CLOSE

S1&S2 power voltages are normal. S1 is on load, and S2 close pulse outputs. Until S2 close status is detected or delay is up to sync close/open detection time, disconnect S2 close pulse output. At the same time S1 open pulse outputs; until S1 is opened or delay is over sync close/open detection time, disconnect S1 open pulse outputs. In synchronizing process if close/open time is over sync close/open detection time, then close/open failure alarm is initiated.

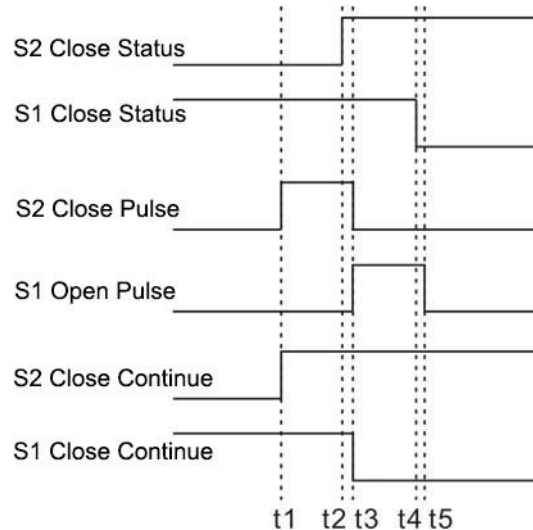

Fig. 5 - S2 Sync Close Procedure Oscillogram

### 12.3.3 MANUAL SYNC CLOSE

When it is manual mode, and S1&S2 power are normal, if S1 is closed, press S2 close key and S2 closes synchronously. If S2 is closed, press S1 close key, and S1 closes synchronously. In the process of waiting for sync, press close key again and sync close is stopped. If sync waiting is overtime, sync failure warning alarm is initiated; but it will continue waiting to sync, until sync is completed, or cancel sync close by pressing close key.

### 12.3.4 AUTO SYNC CLOSE

When it is auto mode and backup power is normal and backup is closed, master will sync close if master power recovers.



**WARNING:** when sync close is active, S1 and S2 may be in parallel. If system is S1 Mains S2 Mains, please do the locking on switch side to prevent S1 and S2 close at the same time. Otherwise, it may cause switch or lines burning or personal injury if it is serious.

### 13 ATS POWER SUPPLY

Switch Power Type can be set as DC Power or AC Power. If DC Power is selected, then the switch can be transferred at any time, even when both S1 and S2 are in outage. If AC Power is selected, whether the power is normal or not should be judged according to the AN voltage status of S1 and S2 and AC power voltage range.

The controller will intelligently control power supply when the power of ATS switch is from S1 and S2. As long as one voltage of S1 and S2 is normal, the controller can ensure ATS voltage power is normal and can be transferred properly. ATS power supply is outputted via LO and NO, and it will send close/open signal only when the controller detects normal voltage power.

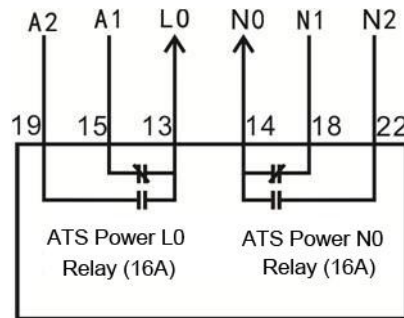

**Fig. 6 - Internal Wiring of ATS Power LO-NO Output**

## 14 NEL CONTROL

### 14.1 ILLUSTRATION

Non-essential load --- NEL for short, refers to load can be ramped off in prior when genset power is out of shortage.

The controller can control the NEL1, NEL2 and NEL3 to trip separately. The order of the essentiality is: NEL3 > NEL2 > NEL1

### 14.2 AUTO OPERATION

**NEL Trip Enabled:** If the genset power has exceeded the NEL trip value, after the trip delay, NEL1 will trip the earliest, and then is NEL2, NEL3.;

**NEL Auto Reconnection Enabled:** If the genset power has fallen below the auto reconnection set value, after the auto reconnection delay, NEL3 will be reconnected the earliest, and next is NEL2, NEL1.

t1: NEL Trip Delay  
t2: Reconnection Delay

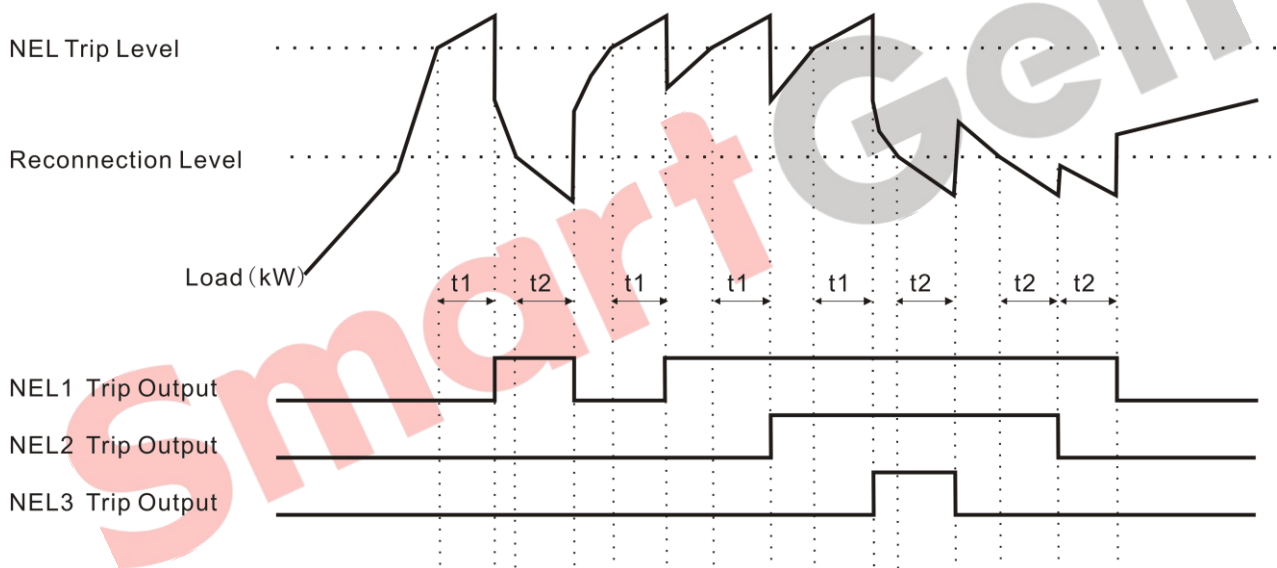

**Fig. 7 - NEL Control Sequence Drawing**

### 14.3 MANUAL OPERATION

If NEL manual trip input is active (earthed failing edge is active), NEL1 will trip without delay; If NEL manual trip input is active again, NEL2 will trip; If NEL manual trip input is active for the third time, NEL3 will trip. At this time the controller does not detect whether the genset power has exceeded the NEL trip value or not.

If NEL manual reconnection input is active (earthed failing edge is active), NEL3 will be reconnected without delay; If NEL manual reconnection input is active again, NEL2 will be reconnected; If NEL manual reconnection input is active for the third time, NEL1 will be reconnected. At this time the controller detects the genset power: if the genset power has fallen below the NEL reconnection value, then the input is active; if it doesn't, the input is deactivated.

**NOTE6:** When auto trip and auto reconnection are enabled, manual trip is still active.

## 15 COMMUNICATION CONFIGURATION

HAT880 ATS controller is with 2 RS485 communication ports, which allow it to connect LAN with open structure. It uses Modbus protocol via PC or system software, and provides dual power switching management plan to factories, telecom, industrial and civil buildings, realizing “remote control, remote measuring, remote communication” functions.

For details of communication protocol, please refer to *HAT880 Communication Protocol*.

### Communication parameters:

Module address 1 (range: 1-254)  
 Baud rate 9600 bps (2400/4800/9600/19200bps)  
 Data bit 8-bit  
 Parity bit None (None, Odd Parity, Even Parity)  
 Stop bit 2 bits (1 bit or 2 bits)

There is a D-type USB port which can be used to connect with PC for software testing, parameter configuration and module software as well.

## 16 TERMINALS

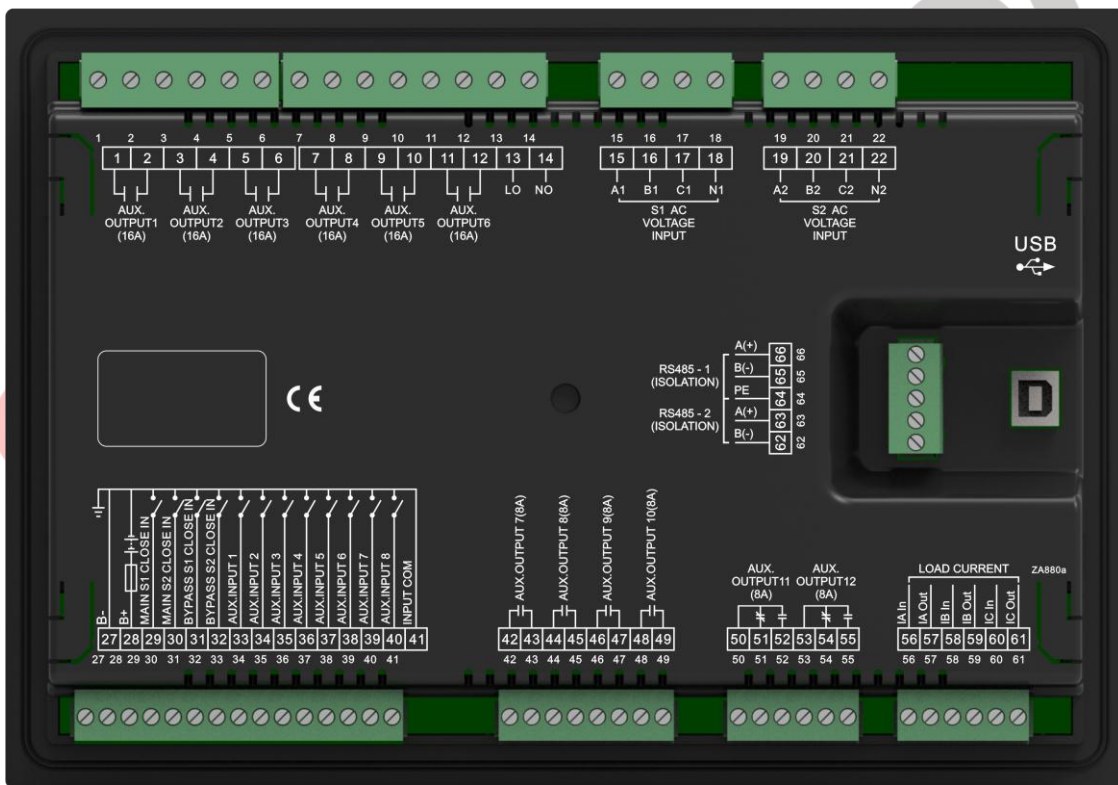

Fig. 8 - Controller Rear Panel Drawing

Table 23 - Inputs/Outputs Function Description

No.	Items	Description	Remark
1	AUX.OUTPUT1	Relay Output1	Default: MS1 Close Control;
2			Volts free N/O output;
3	AUX.OUTPUT2	Relay Output2	Default: MS2 Close Control;
4			Volts free N/O output;
			Capacity: 250V16A



No.	Items	Description	Remark
5	AUX.OUTPUT3	Relay Output3	Default: MS1 Open Control; Volts free N/O output; Capacity: 250V16A
6			
7	AUX.OUTPUT4	Relay Output4	Default: MS2 Open Control; Volts free N/O output; Capacity: 250V16A
8			
9	AUX.OUTPUT5	Relay Output5	Default: BPS1 Close Control Volts free N/O output; Capacity: 250V16A
10			
11	AUX.OUTPUT6	Relay Output6	Default: BPS2 Close Control Volts free N/O output; Capacity: 250V16A
12			
13	LO	ATS Power L	Power supply for ATS switching
14	NO	ATS Power N	
15	A1	S1 AC 3P4W voltage input	For single phase, only connect A1, N1.
16	B1		
17	C1		
18	N1		
19	A2	S2 AC 3P4W voltage input	For single phase, only connect A2, N2.
20	B2		
21	C2		
22	N2		
27	B-	DC negative pole	Ground terminal
28	B+	DC positive pole	DC(8-35)V input; controller power;
29	MAIN S1 CLOSE IN	Detect S1 close status, volt free contactor input	Ground connected is active.
30	MAIN S2 CLOSE IN	Detect S2 close status, volt free contactor input	Ground connected is active.
31	BYPASS S1 CLOSE IN	Detect BPS1 close status, volt free contactor input	Ground connected is active.
32	BYPASS S2 CLOSE IN	Detect BPS1 close status, volt free contactor input	Ground connected is active.
33	AUX. INPUT 1	Digital Input1	Default: Forced Open Ground connected is active.
34	AUX. INPUT 2	Digital Input2	Default: Breaker Trip Input Ground connected is active.
35	AUX. INPUT 3	Digital Input3	Default: BTS Unlocked Status Ground connected is active.
36	AUX. INPUT 4	Digital Input4	Default: ATS In Work Ground connected is active.
37	AUX. INPUT 5	Digital Input5	Default: ATS In Test Ground connected is active.
38	AUX. INPUT 6	Digital Input6	Default: ATS Unlocked Status Ground connected is active.

No.	Items	Description	Remark
39	AUX. INPUT 7	Digital Input7	Default: BTS In Work Ground connected is active.
40	AUX. INPUT 8	Digital Input8	Default: BTS In Test Ground connected is active.
41	INPUT COM	Ground terminal	Connect to B- internally.
42	AUX. OUTPUT 7	Relay Output7	Default: BPS1 Open Control Volts free Relay N/O output. Capacity: 250V8A
43			
44	AUX. OUTPUT 8	Relay Output8	Default: BPS2 Open Control Volts free Relay N/O output. Capacity: 250V8A
45			
46	AUX. OUTPUT 9	Relay Output9	Default: Parallel Warning Volts free Relay N/O output. Capacity: 250V8A
47			
48	AUX. OUTPUT 10	Relay Output10	Default: Not Used; Volts free Relay N/O output. Capacity: 250V8A
49			
50	AUX. OUTPUT 11	COM	Default: Genset Start; Volts free; Relay N/C output. Capacity: 250V8A
51		N/C	
52		N/O	
53	AUX. OUTPUT 12	COM	Default: Not Used Volts free; Relay N/O output. Capacity: 250V8A
54		N/C	
55		N/O	
56	IA In	CT Secondary A-Phase current input	
57	IA Out		
58	IB In	CT Secondary B-Phase current input	
59	IB Out		
60	IC In	CT Secondary C-Phase current input	
61	IC Out		
62	RS485-2 B(-)	RS485-2 communication port	120Ω impedance resistance should be connected externally according to on-site network organization.
63	RS485-2 A(+)		
64	PE	Ground terminal	
65	RS485-1 B(-)	RS485-1 communication port	120Ω impedance resistance should be connected externally according to on-site network organization.
66	RS485-1 A(+)		
USB	USB	Form D USB communication port	Parameter configuration and software upgrading via connecting with PC.

## 17 TYPICAL WIRING DIAGRAM

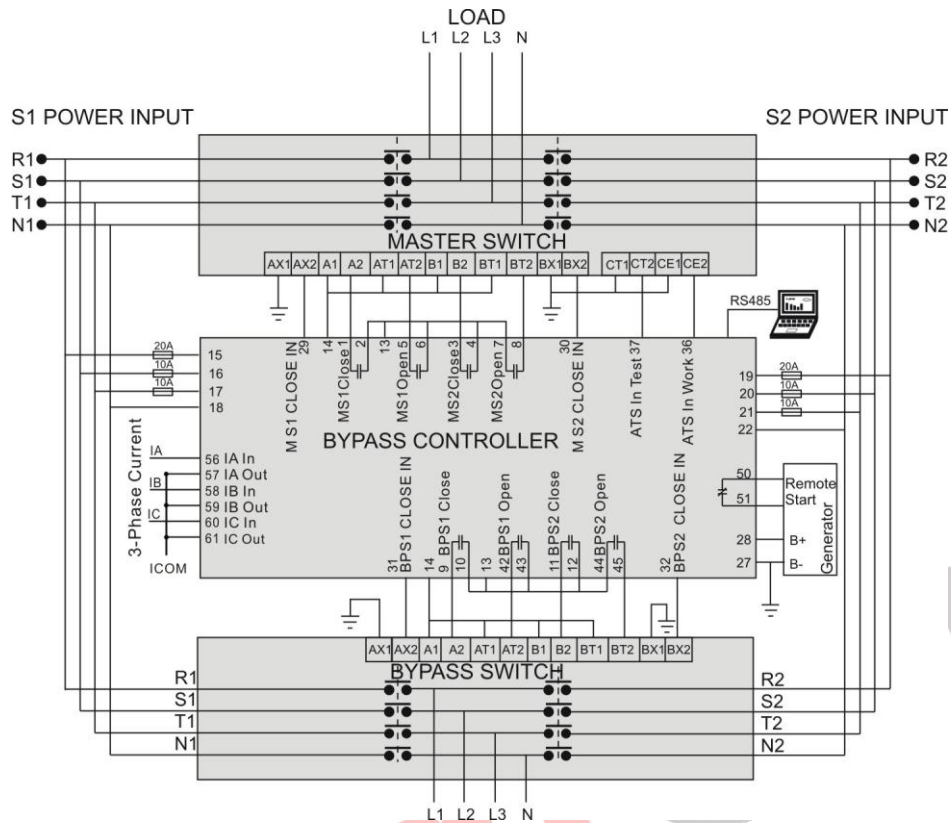

**Fig. 9 - Remote Control Application Diagram of Dual Bypass**

A1, A2: S1 close coil; AT1, AT2: S1 open coil; AX1, AX2: S1 close auxiliary status;  
 B1, B2: S2 close coil; BT1, BT2: S2 open coil; BX1, BX2: S2 close auxiliary status;  
 CT1, CT2: switch is in test. CE1, CE2: switch is in work position.

**Table 24 - Remote Control Parameter Settings of Dual Bypass**

Partial Parameter Setting	
Bypass function type	Dual bypass DBTSE
Bypass switch type	Remote bypass switch RTSE
Aux. Output 1	MS1 close control
Aux. Output 2	MS2 close control
Aux. Output 3	MS2 open control
Aux. Output 4	MS2 open control
Aux. Output 5	BPS1 close control
Aux. Output 6	BPS2 close control
Aux. Output 7	BPS1 open control
Aux. Output 8	BPS2 open control
Aux. Output 9	Parallel power warning
Aux. Output 11	Genset Start
Aux. Input 4	ATS is in work position.
Aux. Input 5	ATS is in test position.



## 18 INSTALLATION

Controller is panel built-in design; and it is fixed by clips when installed.

Unit: mm

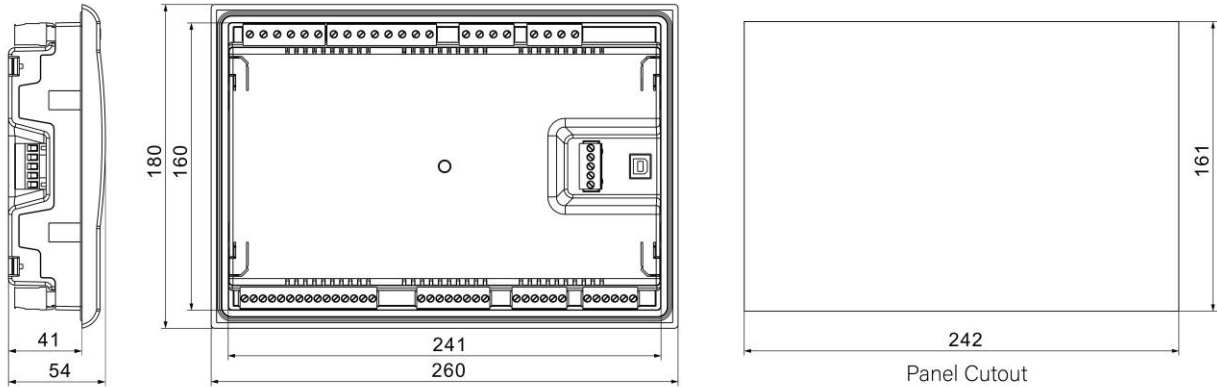

**Fig. 10 - Overall & Cutout Dimensions**

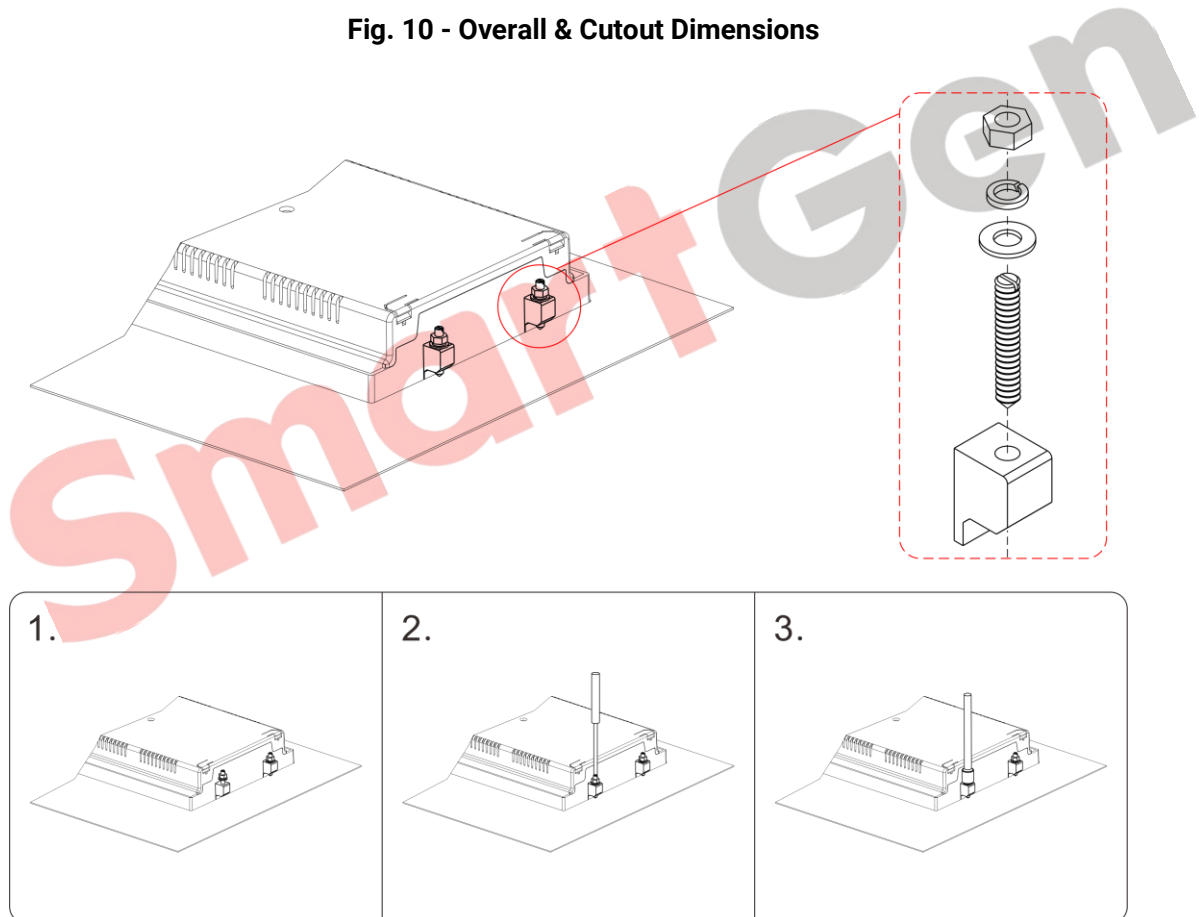

**Fig. 11 - Clip Installation Drawing**

Installation Steps:

1. Install 4 clip parts in turn and put into the grooves on front panel.
2. Tighten the 4 bolts in turn by using straight screwdriver.
3. Tighten the 4 hex nuts by using M4 nut driver.



## 19 TROUBLE SHOOTING

**Table 25 - Troubleshooting**

Symptoms	Possible Solutions
Controller no response with power.	<p>Check DC voltage.</p> <p>Check DC fuse.</p> <p>Check AC Power supply.</p>
RS485 communication is abnormal.	<p>Check RS485's connections of A and B is reversely connected or not.</p> <p>Check RS485 transfer model is damaged or not.</p> <p>Check the module address in parameter setting is correct or not.</p> <p>If above methods can't solve the problem, parallel connecting 120Ω resistor between RS485 A terminal and B terminal is recommended.</p>
Auxiliary Output Error	<p>Check auxiliary output wiring, and pay attention to N/O contactor and N/C contactor.</p> <p>Check the output functions and output type settings in parameter settings.</p>
Auxiliary Input Abnormal	<p>Ensure that the auxiliary input is soundly connected to GND when it's active, meanwhile hung up when it is inactive. (▲NOTE: The input port will be possibly destroyed when connected with high voltage)</p> <p>Check the input functions and active input type settings in parameter settings.</p>
Genset running while ATS not transfer	<p>Check ATS.</p> <p>Check the connection wirings between the controller and the ATS.</p> <p>Check ATS parameter settings.</p>
Genset Start Abnormal	<p>Check system type setting.</p> <p>Check the output function settings and output types in parameters settings.</p> <p>Check all Start/Stop settings.</p>